



# SURGICAL INSTRUMENTS



## YOUR BENEFITS

- One source of supply.
- Wide range of high quality instruments.
- Long lifetime with careful handling.
- Product quality "Made in Germany".
- Excellent instrument processing.
- High-tech manufacturing process.

**PO box 414 Itasca IL 60143**  
**(847) 773-7388**  
**info@elgenvet.com**



EV03180-93  
ø 90 mm



ZIEGLER  
EV03180-90  
compl.



03180-92

EV03180-90  
Ziegler-Stirnspiegel,  
komplett, mit schwarzem  
Stirnreifen,  
mit Kugelgelenk,  
90 mm ø

EV03180-90  
Ziegler Head Mirror,  
complete with black head  
band, with ball socket,  
90 mm ø

EV03180-90  
Ziegler espejo frontal, com-  
pleto con cinta negra,  
con articulación,  
90 mm ø

EV03180-90  
Specchio frontale, Ziegler,  
completo con fascia nera,  
con snodo sferico,  
90 mm di ø

EV03180-92  
Stirnstreifen, allein

EV03180-92  
head band, only

EV03180-92  
cinta, suelta

EV03180-92  
fascia, sola

EV03180-93  
Spiegel, allein  
90 mm ø

EV03180-93  
Mirror, only  
90 mm ø

EV03180-93  
Espejo, suelto  
90 mm ø

EV03180-93  
Specchio, so-  
lo 90 mm ø

Stirnlampe  
Head Light  
Lámpara frontal  
Lampada frontale



CLAR  
EV03195-00

komplett mit Stirnstreifen und Kabel  
complete with head band and cable  
completo con cinta frontal y cable  
completa con fascia frontale e cordone



EV03195-01  
ø 55 mm

Spiegel aus Glas ohne Fassung  
Glass Mirror without frame  
Reflector de cristal, sin montura  
Riflettore di cristallo, senza montatura



EV03195-06  
6 Volt



EV03195-07

Kleintransformator  
220 Volt = 0 - 10 Volt / 3 Watt  
Mini-Transformer Unit Transformador eléctrico pequeño Mini-trasformatore elettrico

EV03195-08

Kleintransformator  
110 Volt = 0 - 10 Volt / 3 Watt  
Mini-Transformer Unit Transformador eléctrico pequeño Mini-trasformatore elettrico

EV03195-09

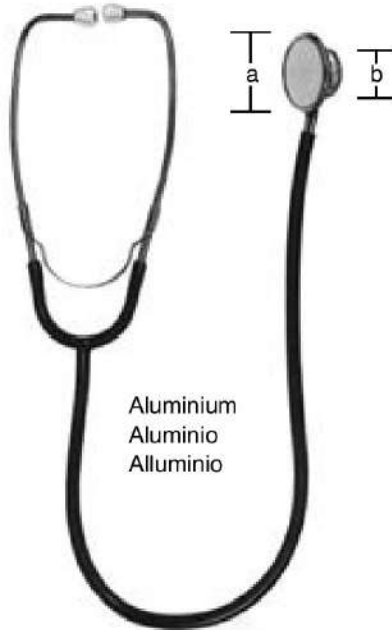
CLAR-Spiegel-Gelenkverbindung  
CLAR special socket joint Articulación especial de CLAR Snodo speciale di CLAR

EV03195-04

Stirnstreifen, alleine  
head band, only  
cinta frontal, suelta  
fascia frontale, sola

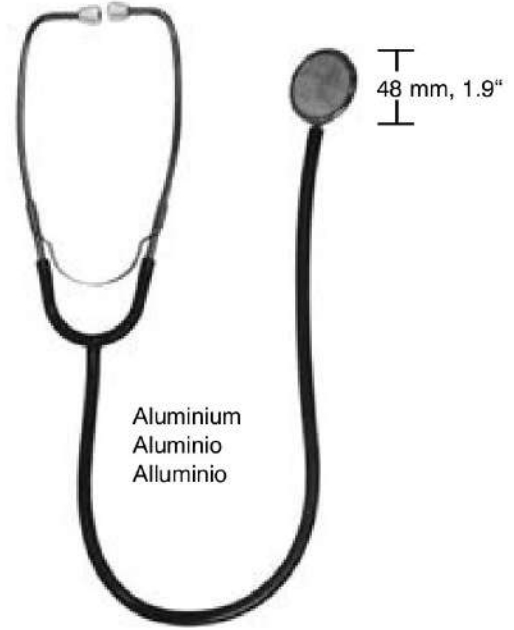
EV03195-10

CLAR Kopfspanne allein aus Metall mit Kabellaschen und Fixierschraube mit Gelenk  
CLAR spring metal head band only, with cable clips and fixing screw with socket joint  
Casco frontal de resorte metálico suelto de CLAR, con bridas de cable, y tornillo de sujeción con articulación  
Fascia metallica a casco di CLAR, solo, con portacordoni e vite di fissaggio a snodo



Aluminium  
Aluminio  
Alluminio

DUPLEX



Aluminium  
Aluminio  
Alluminio

ANESTOPHON  
EV03248-00

|            | a           | b           |          |
|------------|-------------|-------------|----------|
| EV03246-00 | 48 mm, 1.9" | 30 mm, 1.2" |          |
| EV03246-01 | 39 mm, 1.5" | 25 mm, 1.0" | Baby     |
| EV03246-02 | 21 mm, 0.8" | 21 mm, 0.8" | Neonatal |



PINARD  
EV03260-15 15  
cm, 6" ALU



PINARD  
EV03262-18 18 cm, 7"

Holz, wood, madera, legno

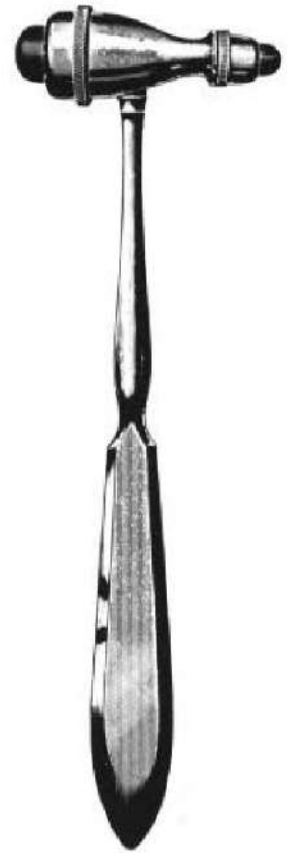
Perkussionshämmer  
 Percussion Hammers  
 Martillos de percusión  
 Martelli da percussione



TAYLOR - USA Mod.  
 EV03288-17 17 cm, 6 3/4"  
 EV03288-20 20 cm, 8"



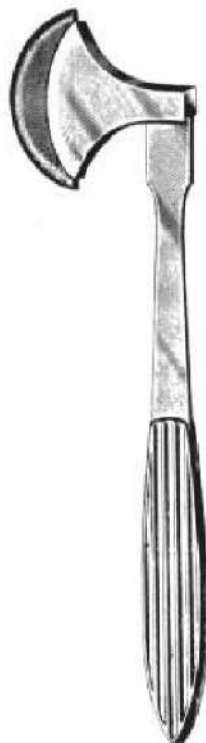
BABINSKY  
 EV03292-22 22 cm, 8 3/4"



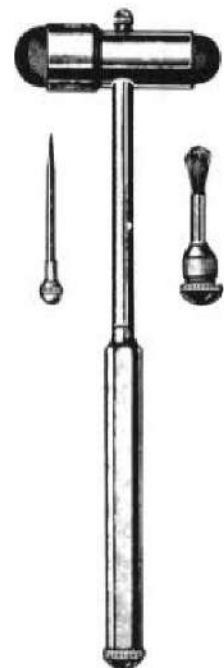
TROEMNER  
 EV03294-24 24 cm, 9 1/2"



DEJERINE  
 EV03304-20 20 cm, 8"



BERLINER  
 EV03306-17 17 cm, 6 3/4"

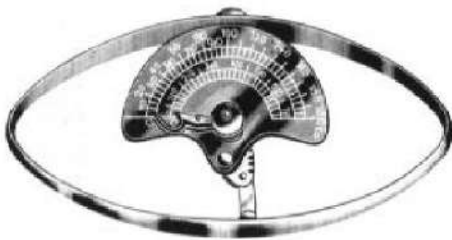


BUCK  
 EV03308-18 18 cm, 7"

Prüf- und Meßinstrumente  
 Examination and Measuring Instruments  
 Instrumentos para exámenes y medidas  
 Strumenti per esaminare e misurare

GERNAL SURGICAL

Dynamometer  
 Dynamometer  
 Dinamómetro  
 Dinamometro

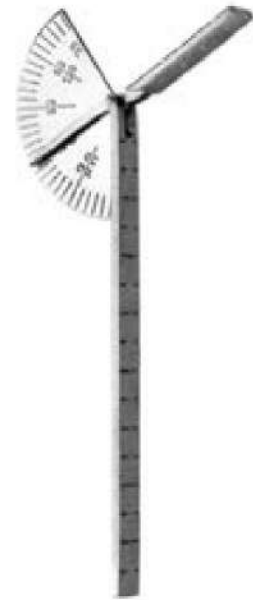


COLLIN  
 EV03310-01 Erwachsene,  
 Adult,  
 adultos, adulti  
 EV03310-02 Kind, child, niños,  
 bambini

Winkelmesser  
 Goniometer  
 Goniómetro  
 Goniometro



MOELTGEN  
 EV03312-01



Finger-Goniometer  
 Finger goniometer  
 Goniómetro para dedos  
 Goniometro per le dita  
 EV03314-01



WARTENBERG  
 EV03320-19 19 cm, 7  
 1/2"



Wachstuchbandmaß  
 Tape Measure, oil cloth  
 Cinta métrica, tela encerada  
 Metro a nastro in tela cerata

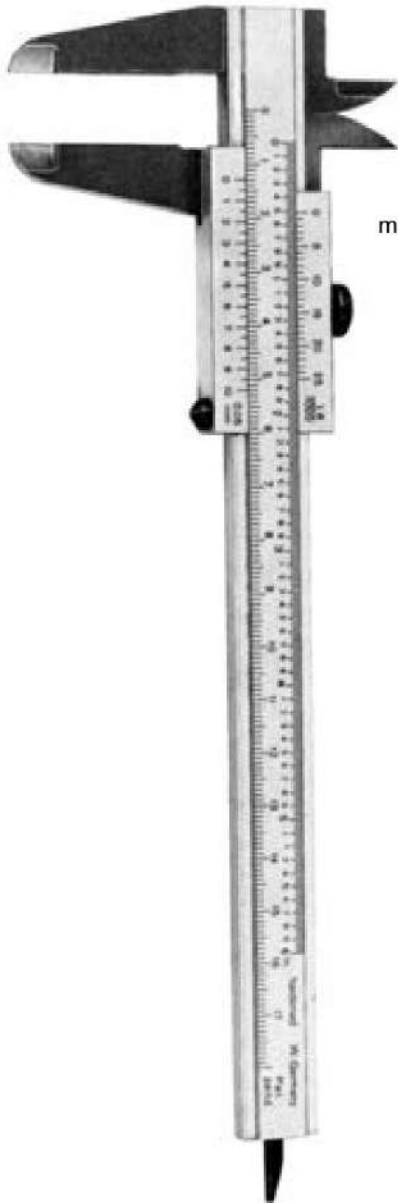
EV03350-15 1,8 m

mm / Inch



Metall

|            |       |     |
|------------|-------|-----|
| EV03340-10 | 10 cm | 4"  |
| EV03340-15 | 15 cm | 6"  |
| EV03340-20 | 20 cm | 8"  |
| EV03340-30 | 30 cm | 12" |
| EV03340-50 | 50 cm | 20" |



mm / Inch

EV03360-21  
21 cm, 8 1/4"



mm / Inch

TOWNLEY  
EV03361-10  
11,5 cm, 4 1/2"

Saugrohre  
Suction tubes  
Tubos de aspiración  
Cannule per aspirazione



POOLE 20 cm, 8"  
EV05130-05 5.5 mm ø, 0.2"  
(17 Fr.)

EV05130-10 10 mm ø, 0.4"  
(30 Fr.)



POOLE 19 cm, 7 1/2"  
EV05140-05 5.5 mm ø, 0.2"  
(17 Fr.)

EV05140-08 8 mm ø, 0.3"  
(23 Fr.)

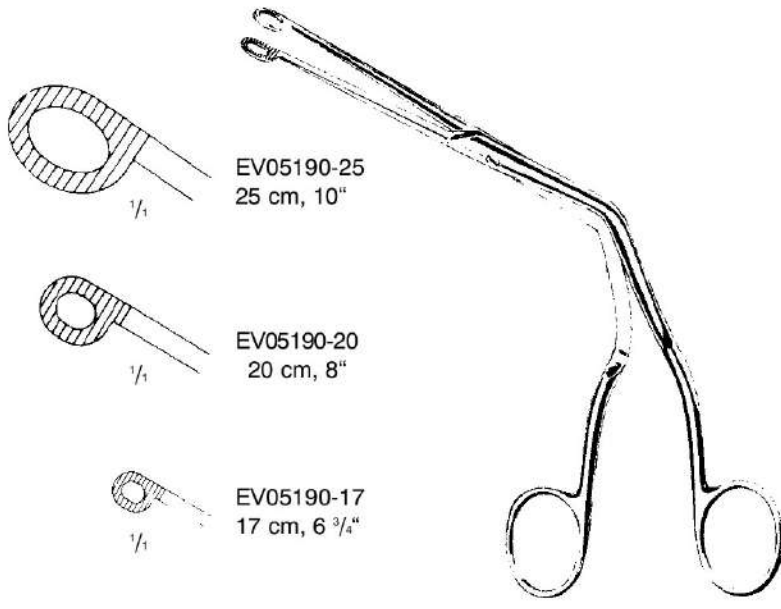


BABY-YANKAUER, compl.  
EV05150-21 21 cm, 8 1/4"

YANKAUER, compl.  
EV05150-27 27 cm, 10 1/2"



Kathetereinführzangen, Saugrohre  
 Catheter Introducing Forceps, Suction tubes  
 Pinzas para catéteres, Tubos de aspiración  
 Pinze per introdurre le sonde, Cannule per aspirazione



MAGILL



ANDREW-PYNCHON  
 EV05170-24  
 6 mm  $\phi$ ,  $1/2$ "  
 24 cm,  $9\ 1/2$ "



COOLEY  
 EV05160-02  
 8 mm  $\phi$ , 0.3"  
 36 cm,  $14\ 1/4$ "



COOLEY  
 EV05160-03  
 8 mm  $\phi$ , 0.3"  
 30 cm,  $11\ 3/4$ "



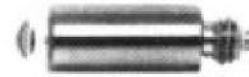
DE BAKLEY  
 EV05160-04  
 3 mm  $\phi$ , 0.1"  
 27 cm,  $10\ 1/2$ "



McINTOSH

|        |         |        |            |
|--------|---------|--------|------------|
| Fig. 0 | 5,5 cm  | 2 1/4" | EV05210-00 |
| Fig. 1 | 7,5 cm  | 3"     | EV05210-01 |
| Fig. 2 | 9,0 cm  | 3 1/2" | EV05210-02 |
| Fig. 3 | 11,0 cm | 4 3/8" | EV05210-03 |
| Fig. 4 | 13,5 cm | 5 1/4" | EV05210-04 |

|            |            |
|------------|------------|
| Cold light | EV05211-00 |
|            | EV05211-01 |
|            | EV05211-02 |
|            | EV05211-03 |
|            | EV05211-04 |



EV05239-03  
Halogen-Lampe  
Halogen Lamp  
Lámpara Halógena  
Lampada Alogena



EV05239-01  
f./p. Fig. 0-1



EV05239-02  
f./p. Fig. 2-4



FOREGGER

|        |         |        |            |
|--------|---------|--------|------------|
| Fig. 0 | 5,5 cm  | 2 1/4" | EV05220-00 |
| Fig. 1 | 7,0 cm  | 2 3/4" | EV05220-01 |
| Fig. 2 | 9,0 cm  | 3 1/2" | EV05220-02 |
| Fig. 3 | 11,0 cm | 4 3/8" | EV05220-03 |
| Fig. 4 | 13,5 cm | 5 1/4" | EV05220-04 |

|            |            |
|------------|------------|
| Cold light | EV05221-00 |
|            | EV05221-01 |
|            | EV05221-02 |
|            | EV05221-03 |
|            | EV05221-04 |



EV05239-03  
Halogen-Lampe  
Halogen Lamp  
Lámpara Halógena  
Lampada Alogena



EV05239-01  
f./p. Fig. 0-1



EV05239-02  
f./p. Fig. 2-4

Laryngoskope  
Laryngoscopes  
Laringoscopios  
Laringoscopi

MILLER



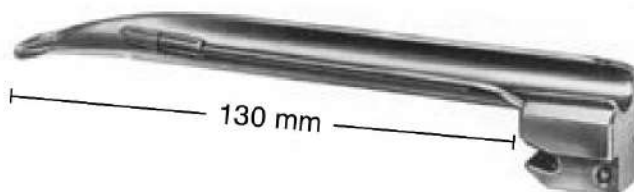
EV05230-00  
55 mm, 2.1/2"  
Nutzlänge  
working length  
largo útil  
lunghezza utile

für Säuglinge  
for babies  
para neonatales  
per neonati



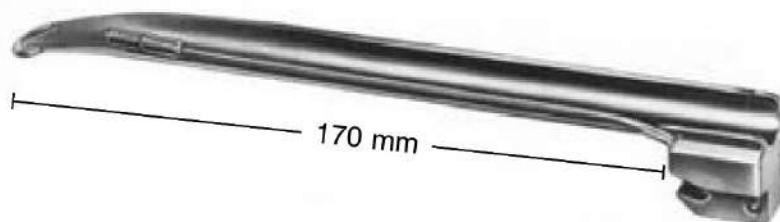
EV05230-01  
80 mm, 3 1/8"  
Nutzlänge  
working length  
largo útil  
lunghezza utile

für Kinder  
for children  
para niños  
per bambini



EV05230-02  
130 mm, 5"  
Nutzlänge  
working length  
largo útil  
lunghezza utile

für Jugendliche  
for adolescents  
para adolescentes  
per adolescenti



EV05230-03  
170 mm, 6 3/4"  
Nutzlänge  
working length  
largo útil  
lunghezza utile

für Frauen  
for women  
para mujeres  
per donne



EV05230-04  
180 mm, 7"  
Nutzlänge  
working length  
largo útil  
lunghezza utile

für Männer  
for men  
para hombres  
per uomini



EV05239-01  
f./p. Fig. 0-1



EV05239-02  
f./p. Fig. 2-4



McINTOSH



FOREGGER

EV05203-00

Set bestehend aus:  
1 Etui  
1 Batteriegriff 05234-28  
3 Spatel (Fg. 1-3)

Set consisting of:  
1 Case  
1 Handle  
3 Blades (Fg. 1-3)

Juego compuesto de:  
1 Estuche  
1 Mango  
3 Hoja (Fg. 1-3)

Set composto da:  
1 Astuccio  
1 Manico  
3 Spatole (Fg. 1-3)

EV05204-00

Set bestehend aus:  
1 Etui  
1 Batteriegriff 05234-28  
4 Spatel (Fg. 1-4)

Set consisting of:  
1 Case  
1 Handle  
4 Blades (Fg. 1-4)

Juego compuesto de:  
1 Estuche  
1 Mango  
4 Hoja (Fg. 1-4)

Set composto da:  
1 Astuccio  
1 Manico  
4 Spatole (Fg. 1-4)

EV05223-00

Set bestehend aus:  
1 Etui  
1 Batteriegriff 05234-28  
3 Spatel (Fg. 2-4)

Set consisting of:  
1 Case  
1 Handle  
3 Blades (Fg. 2-4)

Juego compuesto de:  
1 Estuche  
1 Mango  
3 Hoja (Fg. 2-4)

Set composto da:  
1 Astuccio  
1 Manico  
3 Spatole (Fg. 2-4)

EV05224-00

Set bestehend aus:  
1 Etui  
1 Batteriegriff 05234-28  
4 Spatel (Fg. 1-4)

Set consisting of:  
1 Case  
1 Handle  
4 Blades (Fg. 1-4)

Juego compuesto de:  
1 Estuche  
1 Mango  
4 Hoja (Fg. 1-4)

Set composto da:  
1 Astuccio  
1 Manico  
4 Spatole (Fg. 1-4)

Batteriegriffe, Warmlicht  
Battery handles, warm light  
Mango de pila, luz caliente  
Manico a batteria, luce calda



EV05233-18 18 mm  $\varnothing$ , 3/4"



EV05234-28 28 mm  $\varnothing$ , 1"  
EV05234-37 37 mm  $\varnothing$ , 1 1/2"



EV05238-01 30 mm  $\varnothing$ , 1 1/4"

Batteriegriffe, Kaltlicht  
Battery handles, cold light  
Mango de pila, luz fria  
Manico a batteria per luce fredda



EV05238-02  
18 mm  $\varnothing$   
 $\frac{3}{4}$ "



EV05238-03  
30 mm  $\varnothing$  1  
 $\frac{1}{4}$ "

Batteriegriffe, Warmlicht  
Battery handles, warm light  
Mango de pila, luz caliente  
Manico a batteria, luce calda



EV05240-30 30 mm ø, 1 1/4"  
Griff mit Trafo-Anschluß  
Handle with Transformer-connection  
Mango con conexión al transformador  
Manico con connessione al trasformatore



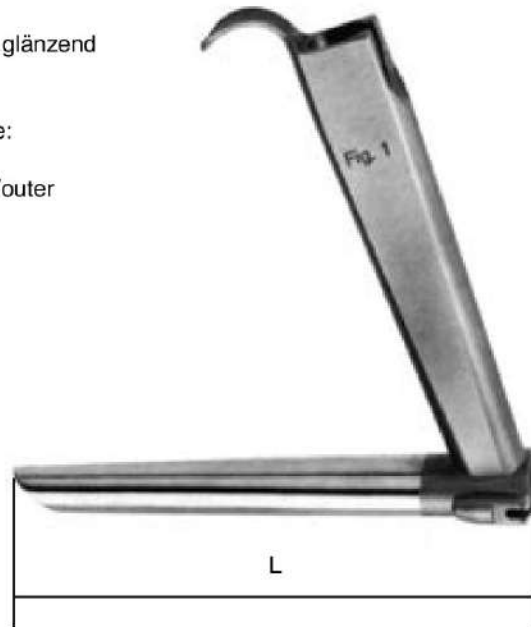
EV05241-11 Trafo 120 V  
EV05241-22 Trafo 230 V

Trafo 120 Volt mit amerikanischem Netzanschluß  
Transformer 120 Volt with american mains connection  
Transformador 120 V con conexión americana Transformatore 120 V ricarica batteria

Trafo 230 Volt mit 1,40 m (55") langem Kabel  
Transformer 230 Volt with cable 1,40 m (55") long  
Transformador, 230 V con cable de 1,40 m (55")  
Trasformatore 230 V ricarica batteria

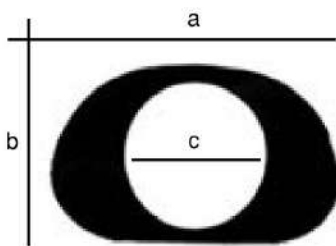
Operation Laryngoskop:  
rostfreier Edelstahl  
Rohr: innen matt/außen glänzend  
Griff: ganz matt

Operation Laryngoscope:  
stainless steel  
tube: inner surface matt/outer  
surface polished  
handle: matt

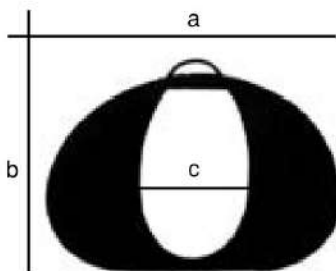


Laringoscopio para operaciones:  
Acero inoxidable  
Pala: Superficie interior: Mate  
Superficie exterior: Brillante  
Mango entero: Mate

Laringoscopio a luce  
fredda per microchirurgia  
endolaringeo  
tubo: interiore opaco – esterno lucido  
manico: opaco



| Nr.        | L<br>(mm) | a<br>(mm) | b<br>(mm) | c<br>(mm) | Lichtträger<br>light guide<br>Portador de luz<br>portatore di luce |
|------------|-----------|-----------|-----------|-----------|--|
| EV05301-01 | 135       | 21,8      | 14,0      | 13,0      | EV05302-01   |
| EV05301-02 | 152       | 22,5      | 14,8      | 13,0      | EV05302-01   |
| EV05301-03 | 182       | 23,0      | 15,0      | 14,0      | EV05302-02   |
| EV05301-04 | 172       | 29,5      | 18,0      | 17,0      | EV05302-02   |
| EV05301-05 | 172       | 31,5      | 21,5      | 19,0      | EV05302-02   |



| Nr.        | L<br>(mm) | a<br>(mm) | b<br>(mm) | c<br>(mm)   | Lichtträger<br>light guide<br>Portador de luz<br>portatore di luce |
|------------|-----------|-----------|-----------|-------------|--|
| EV05301-06 | 182       | 29,0      | 20,0      | 16,0 x 26,0 | EV05302-02   |
| EV05301-07 | 222       | 29,0      | 20,0      | 16,0 x 26,0 | EV05302-03   |



Laryngoskope  
Laryngoscopes  
Laringoscopios  
Laringoscopi

V05300-01/02 Bruststütze für Erwachsene/Kinder bestehend aus:  
 V05300-03 Stützstange für Erwachsene 34 cm / EV05300-06 Ring / EV05300-05 Gelenk  
 V05300-04 Stützstange für Kinder 24 cm / EV05300-06 Ring / EV05300-05 Gelenk  
 V05300-01/02 Chest Support for adults/children complete consisting of:  
 V05300-03 Support rod for adults 34 cm / EV05300-06 Ring / EV05300-05 Joint  
 V05300-04 Support rod for children 24 cm / EV05300-06 Ring / EV05300-05 Joint  
 V05300-01/02 Soporte pectoral para adultos/niños compuesto de:  
 V05300-03 para adultos 34 cm / EV05300-06 / EV05300-05  
 V05300-04 para niños 24 cm / EV05300-06 / EV 05300-05  
 V05300-01/02 Braccio portalarinoscopio sternale per adulti/bambini composto da:  
 V05300-03 per adulti 34 cm / EV05300-06 anello / EV05300-05 giunto  
 V05300-04 per bambini 24 cm / EV05300-06 anello / EV05300-05 giunto

Operationslaryngoskop, Kleinsasser  
 Operation laryngoscope, Kleinsasser  
 Laringoscopios operativo, Kleinsasser  
 Laringoscopia operativo, Kleinsasser



EV05300-03 - 34 cm, 13.4"  
(Erwachsene/adults/adultos/adulti)

EV05300-04 - 24 cm, 9 1/2"  
(Kinder/Children/Niños/Bambini)

EV05300-06  
Ring ring  
anillo anello

EV05300-05  
Gelenk joint  
articulacion  
giunto

Fiberglas-Lichtträger – Fiberglas-light-guide –  
 Portador de luz fria – portatore di luce fredda  
 a fibre di vetro

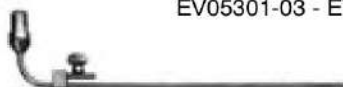
EV05302-01 for Laryngoskope  
EV05301-01 - EV05301-02



EV05303-01  
 Injektionskanüle für Laryngoskope: EV05301-01 - EV05301-07  
 Injetion drain tube for Laryngoscopes: EV05301-01 - EV05301-07  
 Canúla de inyeccion para laringoscopios: EV05301-01 - EV05301-07  
 Cannula da iniezione per laringoscopi: EV05301-01 - EV05301-07



EV05302-02 for Laryngoskope  
EV05301-03 - EV05301-06



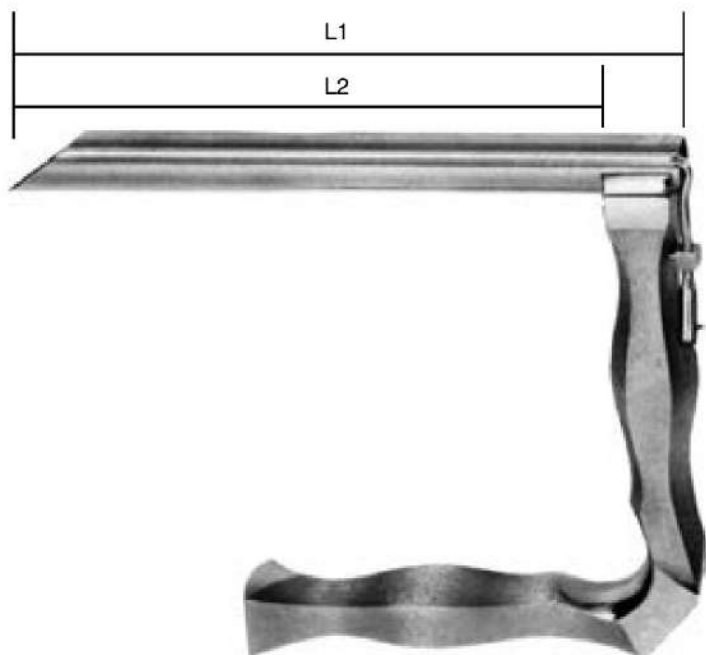
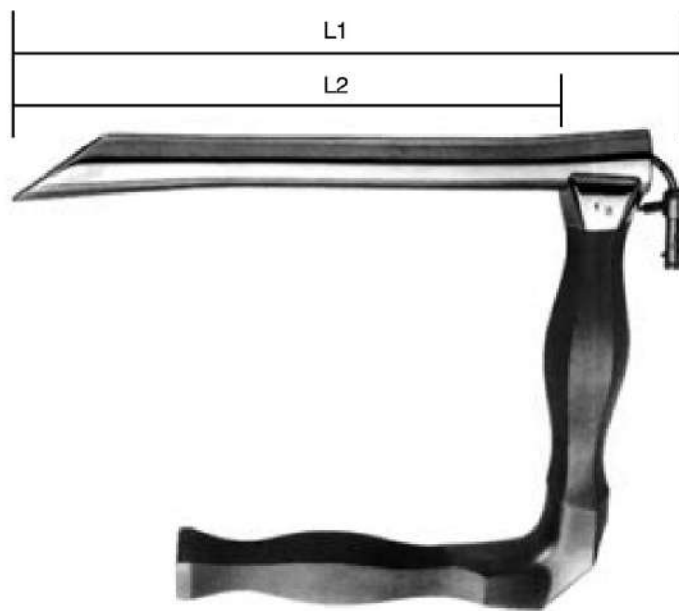
EV05304-01  
 Rauchabsaugrohr für Laryngoskop:  
 Suction tube for Laryngoscopes: EV05301-03 - EV05301-07  
 Canúla de succion para laringoscopios: EV05301-03 - EV05301-07  
 Tubo di aspirazione per laringoscopi: EV05301-03 - EV05301-07

EV05302-03 for Laryngoskope  
EV05301-07



HOLINGER

| Nr.        | L1     | L2     | Lichtträger<br>light guide<br>Portador de luz<br>portatore di luce |
|------------|--------|--------|--|
| EV05310-01 | 180 mm | 157 mm | EV05311-01   |
| EV05310-02 | 170 mm | 146 mm | EV05311-02   |
| EV05310-03 | 120 mm | 98 mm  | EV05311-03   |
| EV05310-04 | 90 mm  | 77 mm  | EV05311-04   |



JACKSON

| Nr.        | L1     | L2     | Außen-Dm<br>Outer-dm<br>dm-exterior<br>dm-esterno | Innen-Dm<br>Inner-dm<br>dm-interior<br>dm-interno | Lichtträger<br>light guide<br>Portador de luz<br>portatore di luce |
|------------|--------|--------|---|---|--|
| EV05320-01 | 160 mm | 135 mm | 17,5 mm   | 14,5 mm   | EV05321-01   |
| EV05320-02 | 160 mm | 135 mm | 14,5 mm   | 12,0 mm   | EV05321-02   |
| EV05320-03 | 120 mm | 105 mm | 14,0 mm   | 11,5 mm   | EV05321-03   |
| EV05320-04 | 90 mm  | 75 mm  | 13,0 mm   | 10,0 mm   | EV05321-04   |

passend zu den Klängen  
for blades  
para las hojas  
per lama bisturi

- (A) No. 10, 11, 12, 13, 14, 15, 16, 17, 18, 19
- (B) No. 20, 21, 22, 23, 24, 25



EV07103-00

Fig. 3

(A)



EV07103-01

Fig. 3 grad.

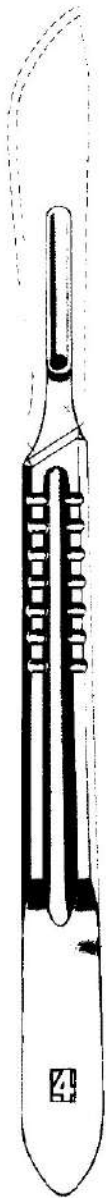
(A)



EV07103-02

Fig. 3 L

(A)



EV07104-00

Fig. 4

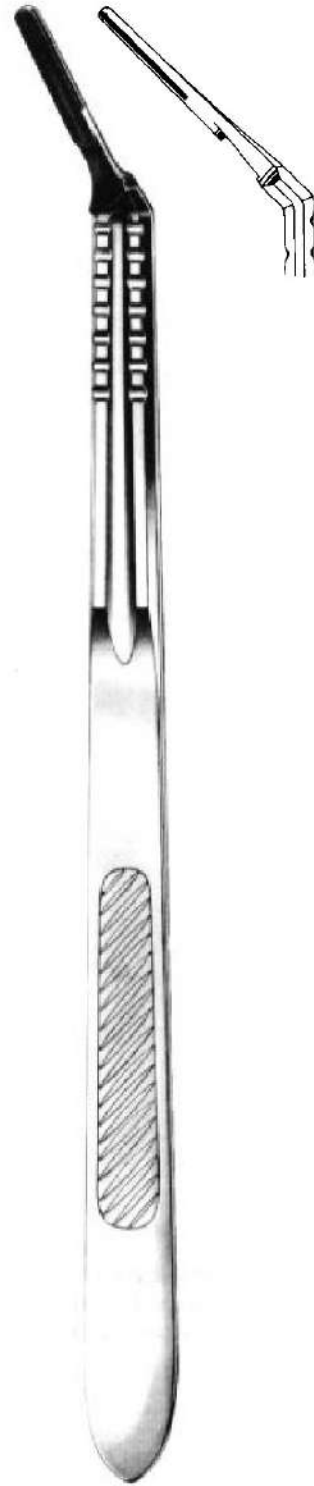
(B)



EV07104-02

Fig. 4 L

(B)



EV07105-02

Fig. 4 L

(B)

Skalpelli-Griffe  
Scalpel Handles  
Mangos de bisturíes  
Manici per lama bisturi



EV07106-01  
14,5 cm 5 3/4"

(A)



EV07106-02  
14 cm 5 1/2"

(A)



EV07107-00  
16,5 cm, 6 1/2"  
Fig. 7

(A)



EV07107-01  
12 cm, 4 3/4"  
Fig. 7K

(A)



EV07107-03  
22,5 cm, 8.9"

(A)



EV07107-04  
22,5 cm, 8.9"

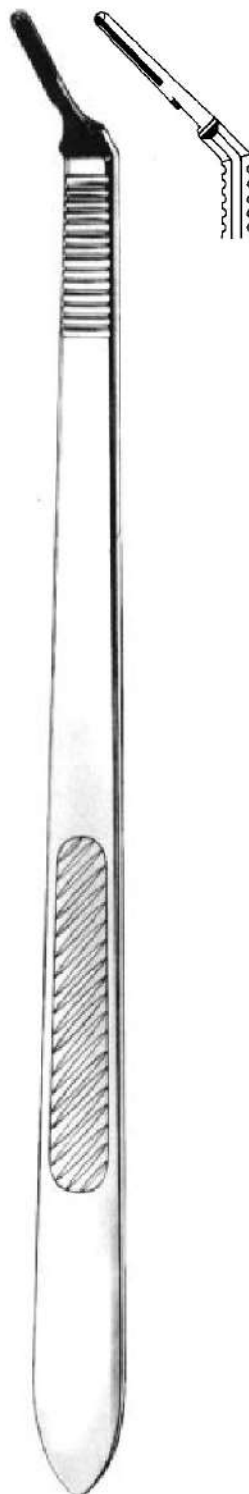
(A)

Skalpelli-Griffe  
Scalpel Handles  
Mangos de bisturíes  
Manici per lama bisturi



EV0710800  
Fig. 8

(A)



EV0710903  
Fig. 3 L

(A)



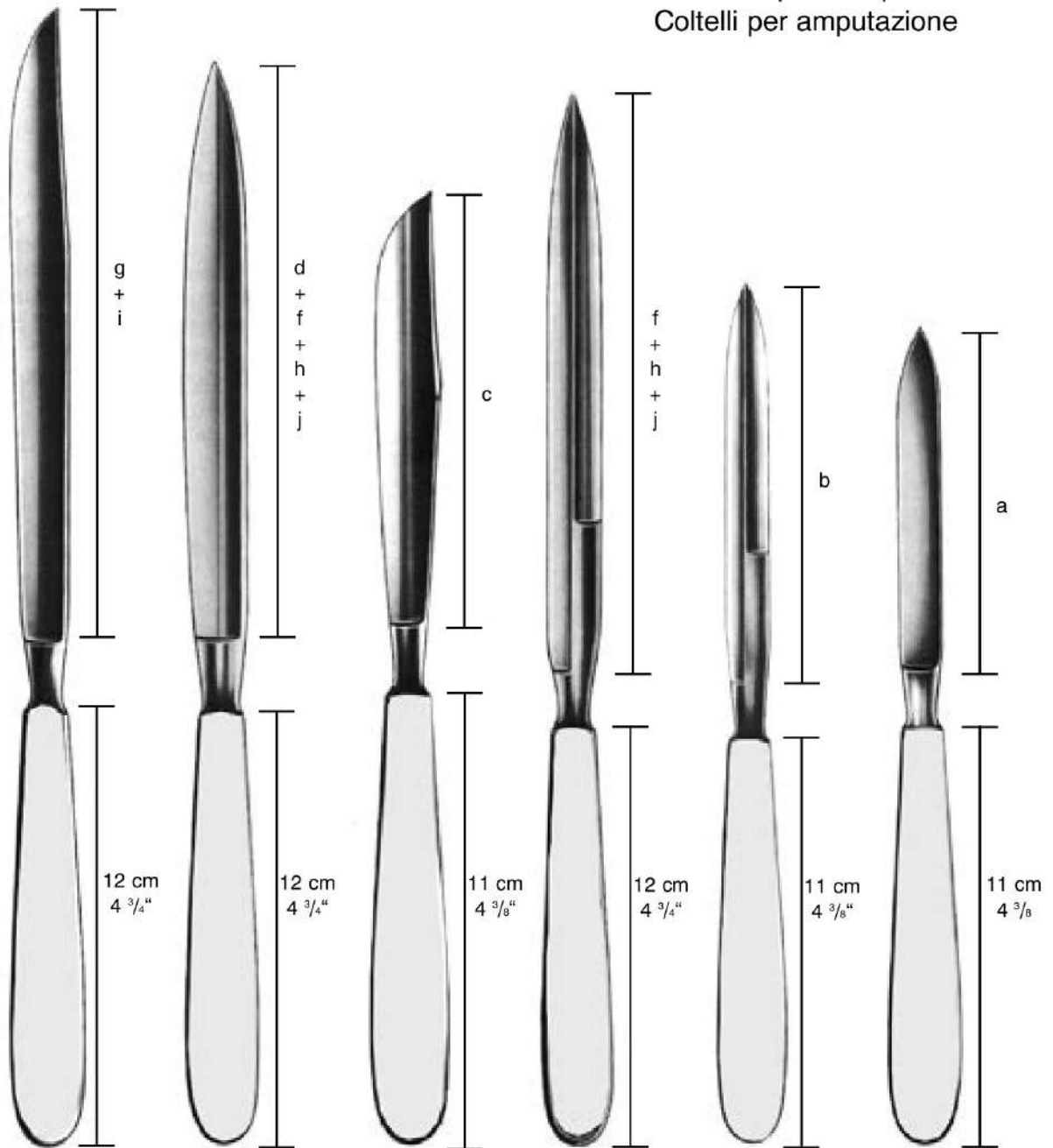
EV07161-00 EV07162-00 0EV7165-00 EV07167-00

Packung mit 10 Stück box of 10  
en cajas de 10 pzas confezione di 10

EV07109-10 10,0 cm, 4"  
EV07109-13 13,0 cm, 5"  
EV07109-15 15,5 cm, 6"



Amputationsmesser  
Amputation Knives  
Cuchillos para amputación  
Coltelli per amputazione



LISTON  
EV07200-17  
EV07200-20

ELGEN  
EV07201-13  
EV07201-16  
EV07201-19  
EV07201-22

LANGENBECK  
EV07202-12

CATLIN dop-  
pelschneidig  
double cutting  
filo doble  
doppio taglio  
EV07203-16  
EV07203-19 0  
EV7203-22

EV07204-11  
Zwischenknochen-  
messer doppel-  
schneidig  
Inerosseous knife  
double cutting  
Cuchillo interóseo  
filo doble  
Coltello interosseo  
doppio taglio

EV07205-09  
Phalangen-  
messer  
Phalangeal knife  
Cuchillos para  
falanges  
Coltello per falangi

Schnittlänge  
Length of blades Largo  
de hojas Lunghezza  
delle lame

|             |             |             |             |             |
|-------------|-------------|-------------|-------------|-------------|
| a - 9,5 cm  | c - 12,0 cm | e - 15,0 cm | g - 17,0 cm | i - 20,0 cm |
| b - 11,0 cm | d - 13,0 cm | f - 16,0 cm | h - 19,0 cm | j - 22,0 cm |
| a - 3 3/4"  | c - 4 3/4"  | e - 6"      | g - 6 3/4"  | i - 8"      |
| b - 4 3/8"  | d - 5"      | f - 6 1/4"  | h - 7 1/2"  | j - 8 3/4"  |

Klingenbrecher, Rasierklingen  
 Blade Breakers, Razor Blades  
 Rompe-hojas, hojas de afeitar  
 Lama di rasoio, Rompilamette



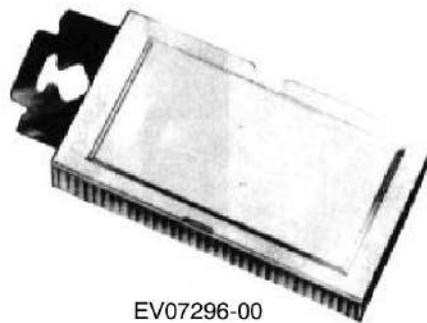
TROUTMAN-CHRIS  
 EV07290-09 9 cm, 3 1/2"



ELGEN  
 EV07291-11 11 cm, 4 3/8"



CASTROVIEJO  
 EV07294-13 13 cm, 5 1/8"



EV07296-00

Packung = 10 Stück  
 package = 10 each  
 caja = 10 c/u  
 confezione = 10 pezzi

Skalpelle mit Metallheft  
 Scalpels with Metal Handle  
 Bisturías, mango metálico  
 Bisturi, manico di metallo



Fig. 1  
 EV07402-01  
 15 cm, 6"  
 30 mm, 1.2"



Fig. 2  
 EV07402-02  
 15 cm, 6"  
 36 mm, 1.4"



Fig. 3  
 EV07402-03  
 15,5 cm, 6"  
 40 mm, 1 1/2"



Fig. 4  
 EV07402-04  
 16 cm, 6 1/4"  
 45 mm, 1 3/4"



Fig. 5  
 EV07402-05  
 16 cm, 6 1/4"  
 50 mm, 2"



Fig. 6  
 EV07402-06  
 15 cm, 6"  
 27 mm, 1"



Fig. 7  
 EV07402-07  
 15 cm, 6"  
 35 mm, 1.4"



Fig. 8  
 EV07402-08  
 16 cm, 6 1/4"  
 40 mm, 1 1/2"



Fig. 9  
 EV07402-09  
 16 cm, 6 1/4"  
 47 mm, 1.9"



Fig. 10  
 EV07402-10  
 17 cm, 6 3/4"  
 50 mm, 2"



19 cm, 7 1/2"

EV07403-01

Metallheft  
 metal handle  
 mango metálico  
 manico di metallo

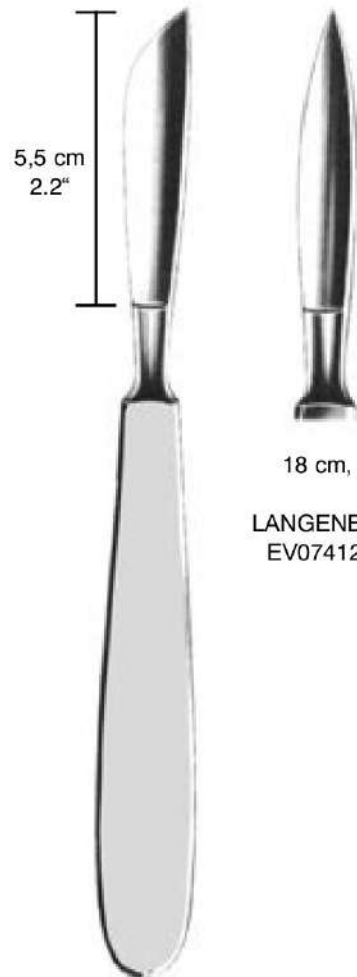
Beinhautmesser  
 mit Schaber  
 Periosteum Knife  
 with raspatory  
 Cuchillo para  
 periostio, con  
 periostótamo  
 Coltello per  
 periostio con  
 raschino



19 cm, 7 1/2"

EV07403-02

Holzheft  
 wooden handle  
 mango de madera  
 manico in legno



18 cm, 7"

LANGENBECK  
 EV07412-05

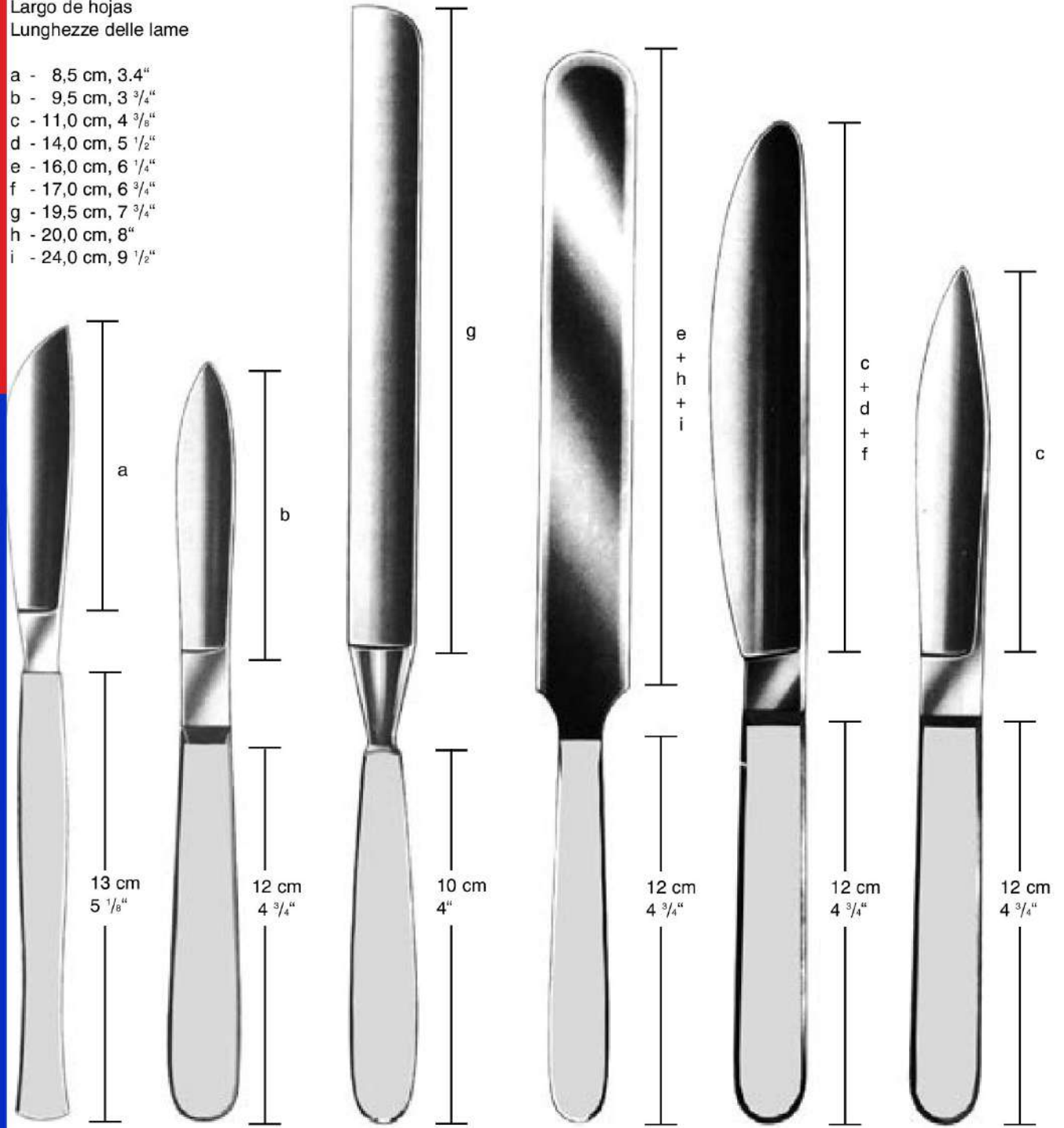
18 cm, 7"

LANGENBECK  
 EV07410-05

Sezier-, Hirn- und Organmesser  
 Autopsy- Brain- and Post mortem knives  
 Cuchillos para autopsia- cerebro- órganos  
 Coltelli per cartilagini- cervello e organi

Schnittlänge  
 Length of blades  
 Largo de hojas  
 Lunhezze delle lame

- a - 8,5 cm, 3.4"
- b - 9,5 cm, 3 3/4"
- c - 11,0 cm, 4 3/8"
- d - 14,0 cm, 5 1/2"
- e - 16,0 cm, 6 1/4"
- f - 17,0 cm, 6 3/4"
- g - 19,5 cm, 7 3/4"
- h - 20,0 cm, 8"
- i - 24,0 cm, 9 1/2"



VIRCHOW  
EV07420-08

VIRCHOW  
EV07421-09

EV07422-19

VIRCHOW  
EV07423-16  
EV07423-20  
EV07423-24

EV07424-11  
EV07424-14  
EV07424-17

EV07425-11

Dermatome, Rasiermesser  
 Dermatome, Razor  
 Dermátomo, Navajas  
 Dermatomo, Rasoio

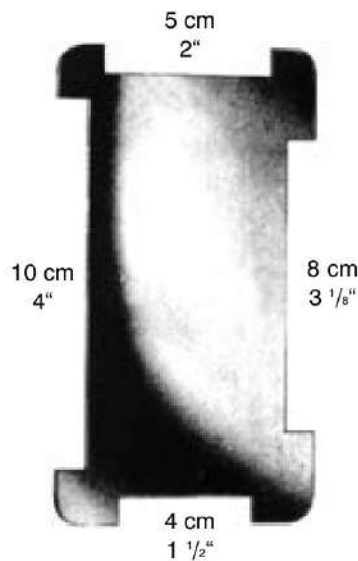


SCHINK  
 EV07490-00 30  
 cm, 11 3/4" 0,1 - 2  
 mm  
 compl.

mit/with/con  
 EV07490-01 (1) Stk./ pcs/ pzas  
 EV07490-02 (2) Stk./ pcs/ pzas



EV07490-01  
 Ersatzklinge  
 Spare blade  
 Hoja de repuesto  
 Lama di ricambio per dermatomo



EV07490-02  
 Spannplatte  
 Skin straightening plate  
 Placa para extender la piel  
 Placca per stendipelle



EV07496-00  
 Rasiermesser 8 cm, 3 1/8"  
 Razors 8 cm, 3 1/8"  
 Navajas 8 cm, 3 1/8"  
 Rasoio 8 cm, 3 1/8"

Dermatome  
 Dermatome  
 Dermátomo  
 Dermatomo



EV07496-31  
 Ersatzklingen  
 Spare blades Ho-  
 ja de repuesto  
 Lama di ricambio

HUMBY EV07495-31 31 cm, 12  
 1/4" 0,1 - 1,5 mm  
 mit 1 Klinge  
 with 1 blade  
 con 1 hoja  
 con 1 lama



für handelsübliche Rasierklingen  
 for usual razor blades  
 para hojas de afeitar usuales  
 per lamette da barba normali

EV07296-00  
 Ersatzklingen  
 Spare blades Ho-  
 ja de repuesto  
 Lama di ricambio

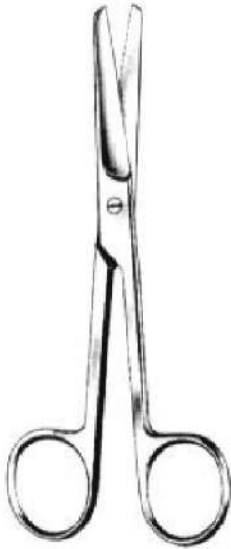
SILVER EV07498-00  
 19 cm, 7 1/2" mit 1  
 Klinge  
 with 1 blade  
 con 1 hoja  
 con 1 lama



EV07499-01 Er-  
 satzklingen Spare  
 blades Hoja de  
 repuesto Lama di  
 ricambio

WATSON EV07499-00  
 30 cm, 11 3/4" 0,1 - 1,5  
 mm  
 mit 1 Klinge  
 with 1 blade  
 con 1 hoja  
 con 1 lama

Chirurgische Scheren  
 Operating Scissors  
 Tijeras para cirugía  
 Forbici per chirurgia



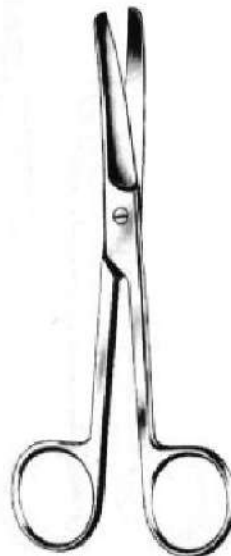
STANDARD  
 EV09102-11 11,5 cm, 4 1/2"  
 EV09102-13 13,0 cm, 5"  
 EV09102-14 14,5 cm, 5 3/4"  
**EV09104-14 TC**  
 EV09102-15 15,5 cm, 6"  
 EV09102-16 16,5 cm, 6 1/2"  
 EV09102-18 18,5 cm, 7 1/4"  
 EV09102-20 20,0 cm, 8"



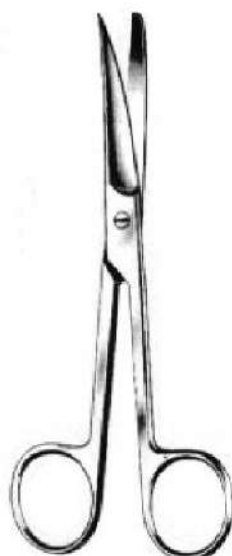
STANDARD  
 EV09110-11 11,5 cm, 4 1/2"  
 EV09110-13 13,0 cm, 5"  
 EV09110-14 14,5 cm, 5 3/4"  
**EV09114-14 TC**  
 EV09110-15 15,5 cm, 6"  
 EV09110-16 16,5 cm, 6 1/2"  
 EV09110-18 18,5 cm, 7 1/4"  
 EV09110-20 20,0 cm, 8"



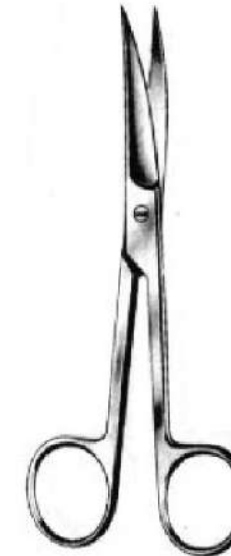
STANDARD  
 EV09120-11 11,5 cm, 4 1/2"  
 EV09120-13 13,0 cm, 5"  
 EV09120-14 14,5 cm, 5 3/4"  
**EV09124-14 TC**  
 EV09120-15 15,5 cm, 6"  
 EV09120-16 16,5 cm, 6 1/2"  
 EV09120-18 18,5 cm, 7 1/4"  
 EV09120-20 20,0 cm, 8"



STANDARD  
 EV09103-11 11,5 cm, 4 1/2"  
 EV09103-13 13,0 cm, 5"  
 EV09103-14 14,5 cm, 5 3/4"  
**EV09105-14 TC**  
 EV09103-15 15,5 cm, 6"  
 EV09103-16 16,5 cm, 6 1/2"  
 EV09103-18 18,5 cm, 7 1/4"  
 EV09103-20 20,0 cm, 8"



STANDARD  
 EV09111-11 11,5 cm, 4 1/2"  
 EV09111-13 13,0 cm, 5"  
 EV09111-14 14,5 cm, 5 3/4"  
**EV09115-14 TC**  
 EV09111-15 15,5 cm, 6"  
 EV09111-16 16,5 cm, 6 1/2"  
 EV09111-18 18,5 cm, 7 1/4"  
 EV09111-20 20,0 cm, 8"



STANDARD  
 EV09121-11 11,5 cm, 4 1/2"  
 EV09121-13 13,0 cm, 5"  
 EV09121-14 14,5 cm, 5 3/4"  
**EV09125-14 TC**  
 EV09121-15 15,5 cm, 6"  
 EV09121-16 16,5 cm, 6 1/2"  
 EV09121-18 18,5 cm, 7 1/4"  
 EV09121-20 20,0 cm, 8"

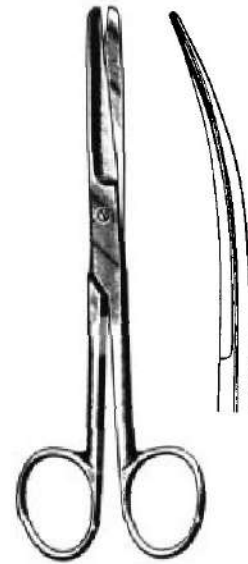


Chirurgische Scheren  
 Operating Scissors  
 Tijeras para cirugía  
 Forbici per chirurgia

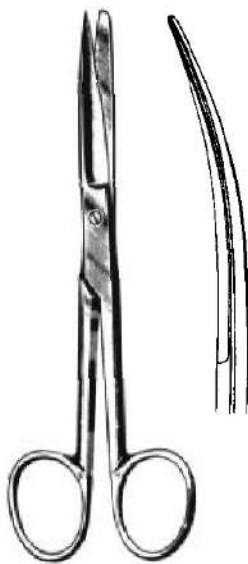


Inzisionsschere  
 Incision Scissors  
 Tijera de incision  
 Forbici per incisione

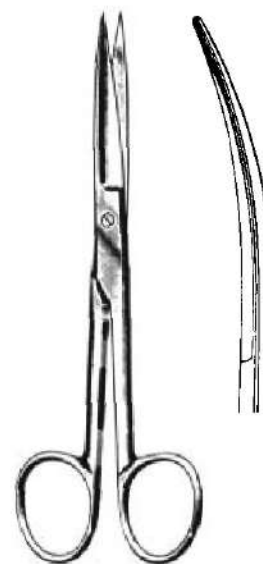
EV09128-14  
 14,0 cm 5  
 1/2"



— DEAVER —  
 EV09130-14 14 cm EV09131-14 5 1/2"



— DEAVER —  
 EV09140-14 14 cm EV09141-14  
 5 1/2"



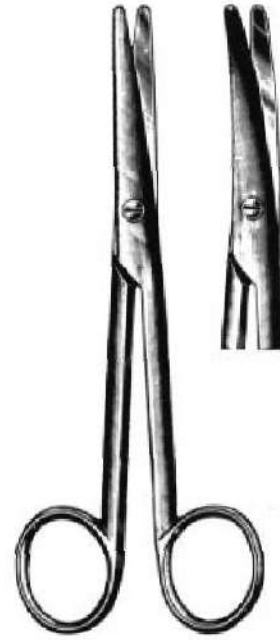
— DEAVER —  
 EV09150-14 14 cm EV09151-14  
 5 1/2"

Präparierscheren  
Dissecting Scissors  
Tijeras de disección  
Forbici per dissezione



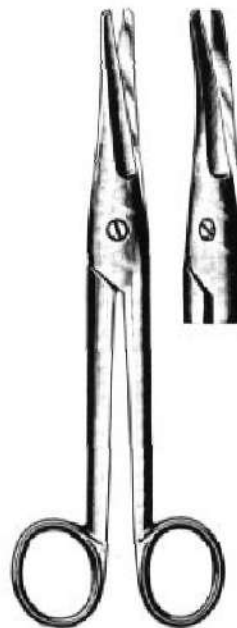
MAYO

- |               |         |               |
|---------------|---------|---------------|
| EV09160-14    | 14,5 cm | EV09161-14    |
| EV09164-14 TC | 5 3/4"  | EV09165-14 TC |
| EV09160-17    | 17,0 cm | EV09161-17    |
| EV09164-17 TC | 6 3/4"  | EV09165-17 TC |
| EV09160-19    | 19,0 cm | EV09161-19    |
|               | 7 1/2"  |               |
| EV09160-23    | 23,0 cm | EV09161-23    |
| EV09164-23 TC | 9"      | EV09165-23 TC |
| EV09160-28    | 28,0 cm | EV09161-28    |
|               | 11"     |               |



MAYO-STILLE

- |               |         |               |
|---------------|---------|---------------|
| EV09170-15    | 15,0 cm | EV09171-15    |
| EV09174-15 TC | 6"      | EV09175-15 TC |
| EV09170-17    | 17,0 cm | EV09171-17    |
| EV09174-17 TC | 6 3/4"  | EV09175-17 TC |
| EV09170-21    | 21,0 cm | EV09171-21    |
| EV09174-21 TC | 8 1/4"  | EV09175-21 TC |



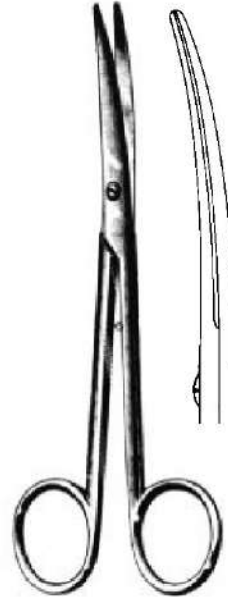
MAYO-NOBLE

- |            |         |            |
|------------|---------|------------|
| EV09180-17 | 17,0 cm | EV09181-17 |
|            | 6 3/4"  |            |

Präparierscheren  
Dissecting Scissors  
Tijeras de disección  
Forbici per dissezione



LEXER  
EV09190-16  
EV09194-16 TC  
16 cm, 6 1/4"



LEXER  
EV09191-16  
EV09195-16 TC  
16 cm, 6 1/4"



LEXER BABY  
EV09202-10 EV09203-10  
EV09206-10 TC EV09207-10 TC  
10 cm, 4"



JORGENSEN  
EV09204-22  
22 cm, 8 3/4"



**METZENBAUM**  
 EV09280-12 EV09284-12 TC  
 12 cm 4 3/4"  
 EV09280-15 EV09284-15 TC  
 15 cm 6"  
 EV09280-18 EV09284-18 TC  
 18 cm 7"  
 EV09280-20 EV09284-20 TC  
 20 cm 8"  
 EV09280-23 EV09284-23 TC  
 23 cm 9"  
 EV09280-25 EV09284-25 TC  
 25 cm 10"  
 EV09280-28 EV09284-28 TC  
 28 cm 11" EV09280-30  
 EV09284-30 TC  
 30 cm 12"



**METZENBAUM**  
 EV09281-12 EV09285-12 TC  
 12 cm 4 3/4"  
 EV09281-15 EV09285-15 TC  
 15 cm 6"  
 EV09281-18 EV09285-18 TC  
 18 cm 7"  
 EV09281-20 EV09285-20 TC  
 20 cm 8"  
 EV09281-23 EV09285-23 TC  
 23 cm 9"  
 EV09281-25 EV09285-25 TC  
 25 cm 10" EV09281-28  
 EV09285-28 TC 28 cm  
 11"  
 EV09281-30 EV09285-30 TC  
 30 cm 12"



**METZENBAUM FINO**  
 EV09282-15 EV09286-15 TC  
 15 cm 6"  
 EV09282-18 EV09286-18 TC  
 18 cm 7"  
 EV09282-20 EV09286-20 TC  
 20 cm 8"  
 EV09282-23 EV09286-23 TC  
 23 cm 9"  
 EV09282-25 EV09286-25 TC  
 25 cm 10"  
 EV09282-28 EV09286-28 TC  
 28 cm 11"



**METZENBAUM FINO**  
 EV09283-15 EV09287-15 TC  
 15 cm 6"  
 EV09283-18 EV09287-18 TC  
 18 cm 7"  
 EV09283-20 EV09287-20 TC  
 20 cm 8"  
 EV09283-23 EV09287-23 TC  
 23 cm 9"  
 EV09283-25 EV09287-25 TC  
 25 cm 10"  
 EV09283-28 EV09287-28 TC  
 28 cm 11"

Präparierschere, Kapselschere  
Dissecting Scissors, Capsula Scissor  
Tijeras de disección, Tijera p. cápsula  
Forbici per dissezione, Forbici per capsula



WELLER  
EV09289-28  
28 cm, 11"



RESANO  
EV09290-25  
25 cm, 10"

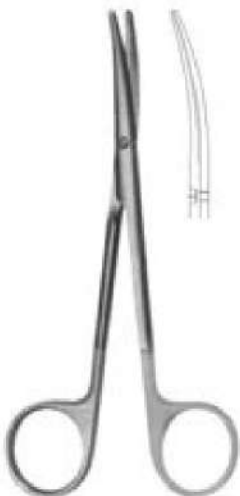
Präparierscheren, Ligaturscheren  
 Dissecting Scissors, Ligature Scissors  
 Tijeras de disección, Tijeras para ligaduras  
 Forbici per dissezione, Forbici per legature



METZENBAUM "S"

EV09291-18 18 cm, 7" EV09295-18 TC  
 EV09291-20 20 cm, 8" EV09295-20 TC  
 EV09291-23 23 cm, 9" EV09295-23 TC

**Wellenschliff - wave cut**



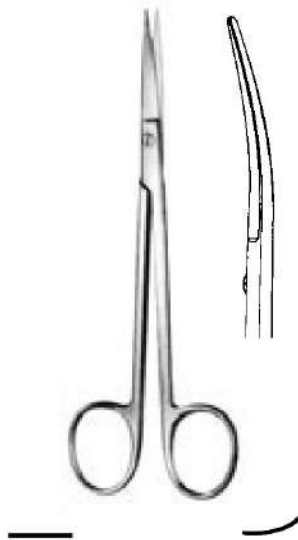
EV09296-15 TC  
 14,5 cm 5 3/4"



EV09296-18 TC  
 18 cm 7"



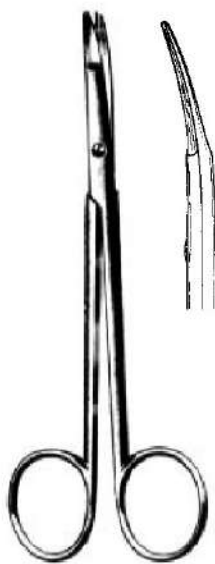
EV09296-23 TC  
 23 cm 9"



SANVENERO  
EV09302-14 14 cm EV09303-14  
5 1/2"



JOSEPH  
EV09304-14 14 cm EV09305-14  
5 1/2"

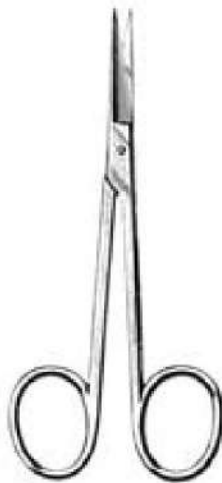


KILNER  
EV09310-12 12 cm EV09314-12 TC  
EV09310-15 15 cm  
EV09312-12 12 cm gerade/straight/recta/retta



REYNOLDS  
EV09320-15 15 cm EV09321-15  
EV09321-18  
EV09325-15 TC

Chirurgische Scheren, fein  
 Operating Scissors, fine  
 Tijeras para cirugía, finas  
 Forbici per chirurgia, fine



IRIS



|                      |       |                      |  |
|----------------------|-------|----------------------|--|
| EV09340-09           | 9 cm  | EV09341-09           |  |
| EV09340-10           | 10 cm | EV09341-10           |  |
| EV09340-11           | 11 cm | EV09341-11           |  |
| <b>EV09344-11 TC</b> |       | <b>EV09345-11 TC</b> |  |

EV09346-11 11 cm

gerade  
 straight  
 rectas  
 rette

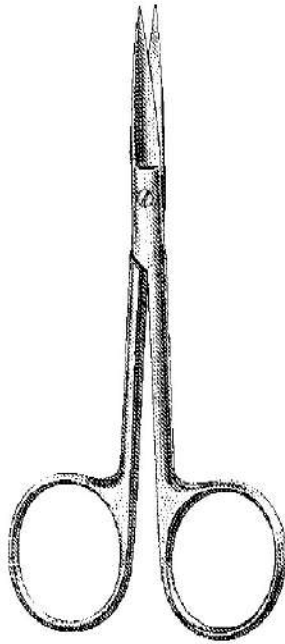
gebogen  
 curved  
 curvas  
 curve

abgewinkelt  
 angled  
 angulada  
 angolata

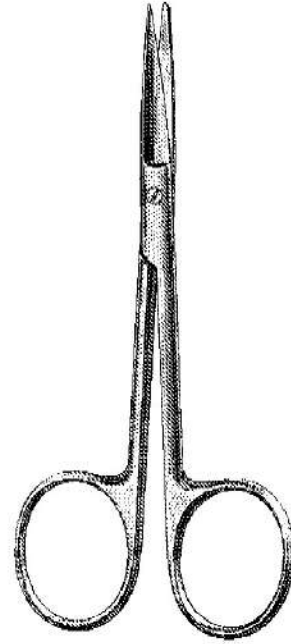




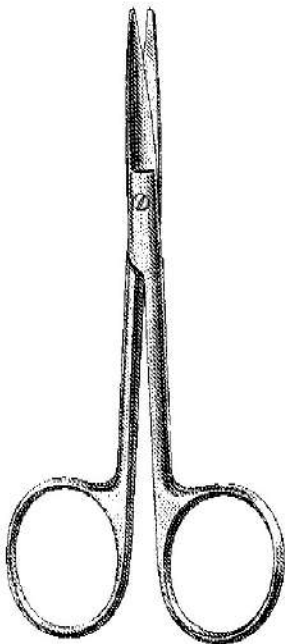
Chirurgische Scheren, Präparierscheren  
 Operating Scissors, Dissecting Scissors  
 Tijeras para cirugía, Tijeras de disección  
 Forbici per chirurgia, Forbici per dissezione



KNAPP  
 10 cm, 4"  
 EV09348-01 EV09348-02



KNAPP  
 10 cm, 4"  
 EV09348-03 EV09348-04

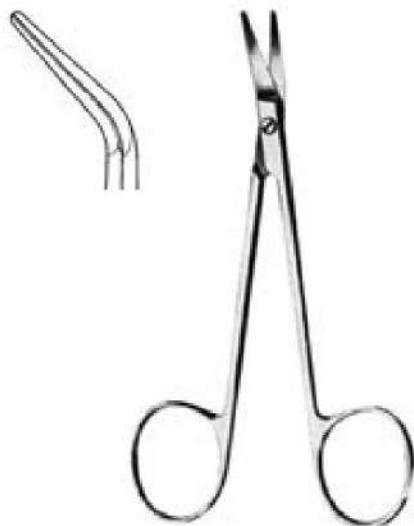


KNAPP  
 10 cm, 4"  
 EV09348-05 EV09348-06



LITTLER  
 EV12 cm, 4 3/4"  
 EV09349-12

Präparierscheren, feines Modell  
Dissecting Scissors, fine pattern  
Tijeras de disección, finas  
Forbici per preparazione, modello fino

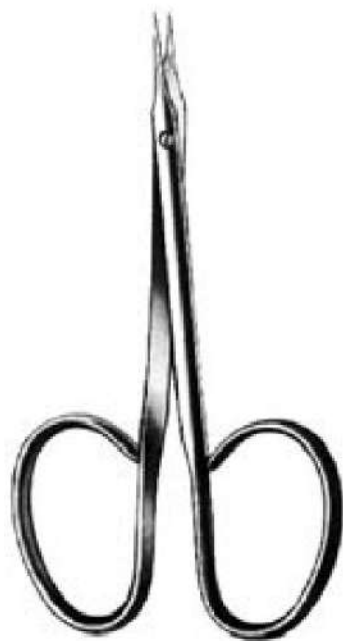


GRAEFE  
EV09350-10  
10 cm 4"

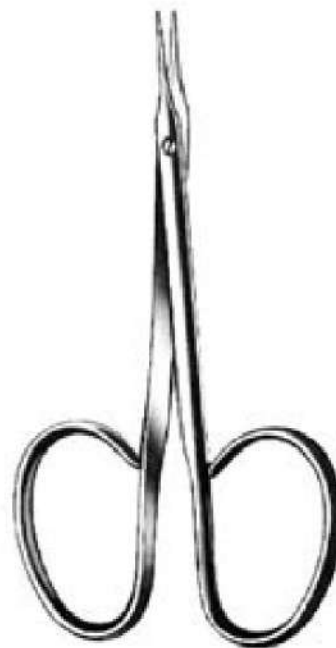


COTTLE  
EV09358-11  
11,5 cm 4 1/2"

Präparierscheren, feines Modell  
Dissecting Scissors, fine pattern  
Tijeras de disección, finas  
Forbici per preparazione, modello fino



— GRADLE —  
EV09350-09 9,5 cm, 3<sup>3</sup>/<sub>4</sub>" EV09351-09



— —  
EV09352-09 9,5 cm, 3<sup>3</sup>/<sub>4</sub>" EV09353-09



— —  
EV09354-10 10 cm, 4" EV09355-10

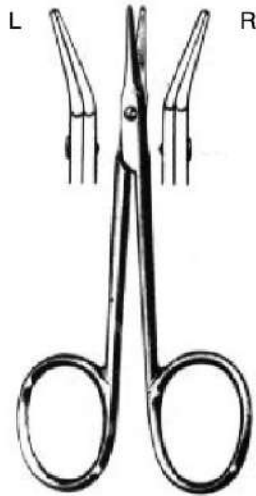


— —  
EV09356-10 10 cm, 4" EV09357-10

Scheren  
Scissors  
Tijeras  
Forbici

Sehnenscheren  
Tendon Scissors  
Tijeras para tendones  
Forbici per tenotomia

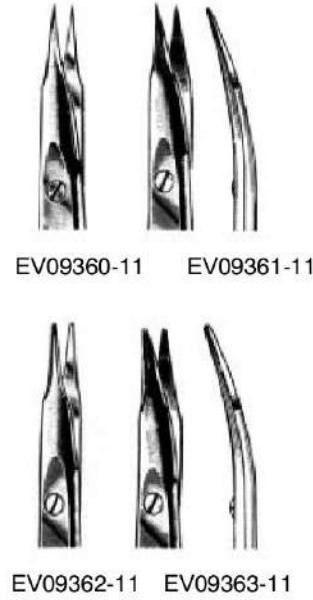
Enucleationsschere  
Enucleation Scissors  
Tijera para enucleación  
Forbici per enucleazione



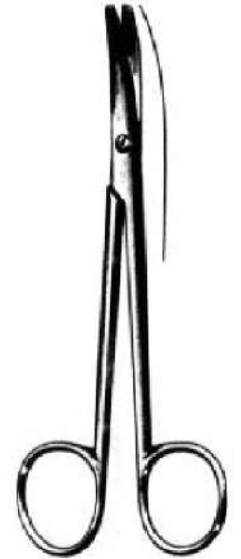
AEBLI  
EV09347-09 9 cm EV 09349-09  
3 1/2"



STEVENS  
11 cm  
4 3/8"



EV09360-11 EV09361-11  
EV09362-11 EV09363-11



LANDOLT  
EV09381-11  
12 cm, 4 3/4"

Nasenscheren - Nasal Scissors - Tijeras nasales - Forbici nasali



STRABISMUS  
EV09370-11 EV09371-11  
EV09374-11 TC EV09375-11 TC  
11 cm, 4 3/8"



HEYMANN  
EV09401-18  
18 cm, 7"

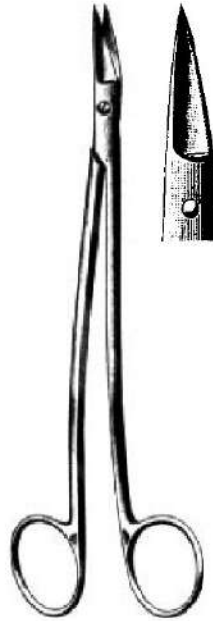


FOMON  
EV09403-15  
15 cm, 6"

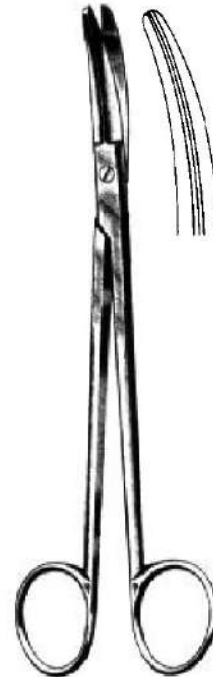
Tonsillen-, Gefäßscheren  
 Tonsil, Vascular Scissors  
 Tijeras amígdalas y vasculares  
 Forbici per tonsilli e vascolari



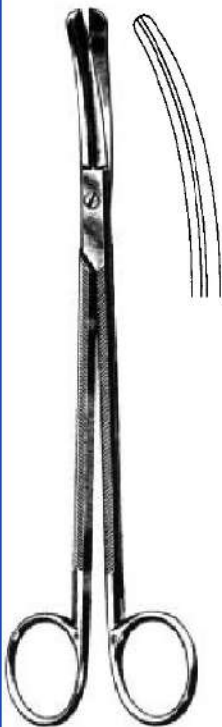
COTTLE  
 EV09405-16  
 EV09406-16 TC  
 16 cm, 6 1/4"



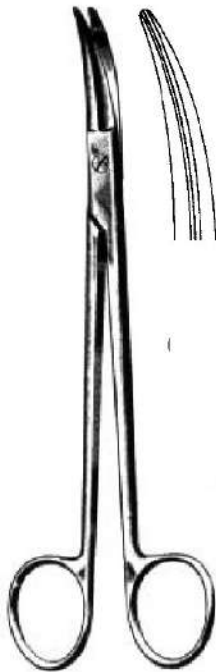
DEAN  
 EV09425-17 EV09427-17  
 17 cm, 6 3/4"



BOETTCHER  
 EV09435-18  
 18 cm, 7"



GOOD  
 EV09437-19  
 19 cm, 7 1/2"



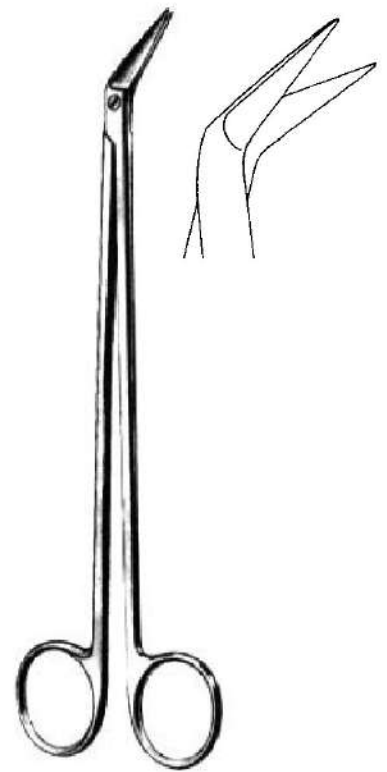
PRINCE  
 EV09439-17  
 17 cm, 6 3/4"



EV09468-15  
 15 cm, 6"



EV09470-11  
 11 cm, 4 3/8"

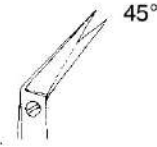


POTTS-DE MARTEL  
 EV09473-21  
 21 cm, 8 1/4"

Scheren, Thorax und Gefäße  
 Scissors, thorax and vascular  
 Tijeras, torácicas y vasculares  
 Forbici vascolari e toraciche



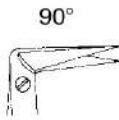
EV09475-25  
 EV09476-25 TC  
 18 cm, 7"



EV09475-45  
 EV09476-45 TC  
 18 cm, 7"



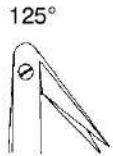
EV09475-60  
 EV09476-60 TC  
 17,5 cm, 6.9"



EV09475-90  
 EV09476-90 TC  
 17 cm, 6 3/4"



EV09475-00  
 EV09476-00 TC  
 17 cm, 6 3/4"



DIETRICH  
 EV09477-01  
 17 cm, 6 3/4"

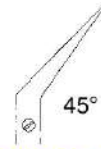
DIETRICH  
 EV09475-25 – EV09475-00  
 17 cm, 6 3/4"



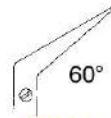
DE BAKEY  
 (POTTS-SMITH)



EV09478-25  
 19 cm  
 7 1/2"



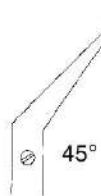
EV09478-45  
 19 cm  
 7 1/2"



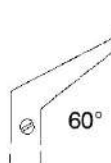
EV09478-60  
 19 cm  
 7 1/2"



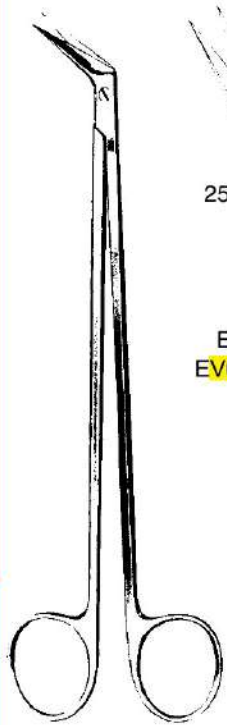
EV09479-25  
 23 cm  
 9"



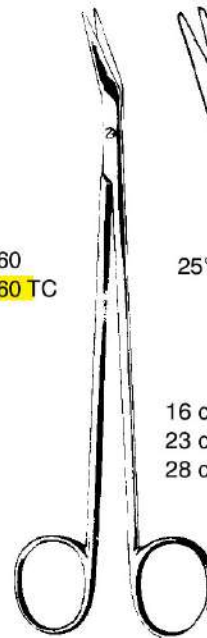
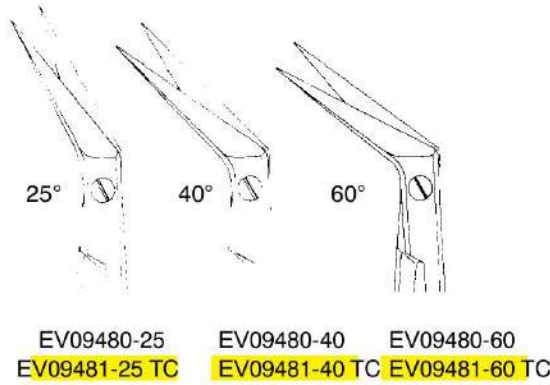
EV09479-45  
 23 cm  
 9"



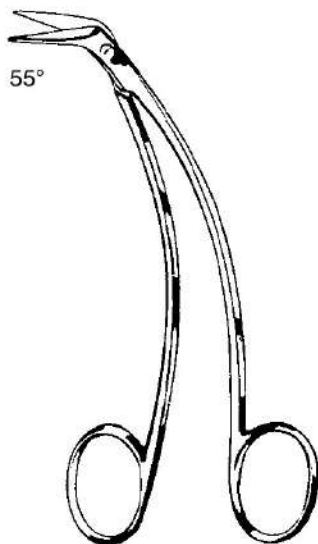
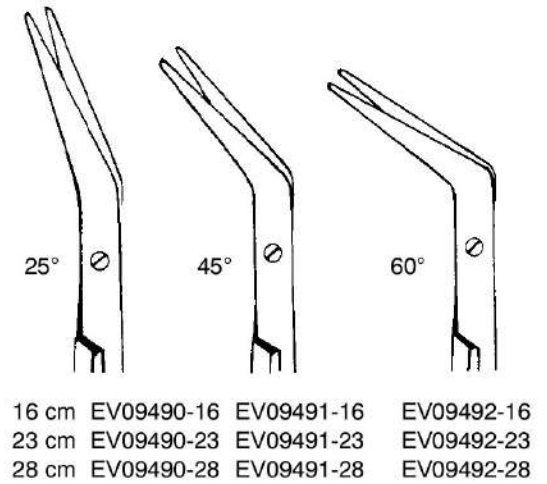
EV09479-60  
 23 cm  
 9"



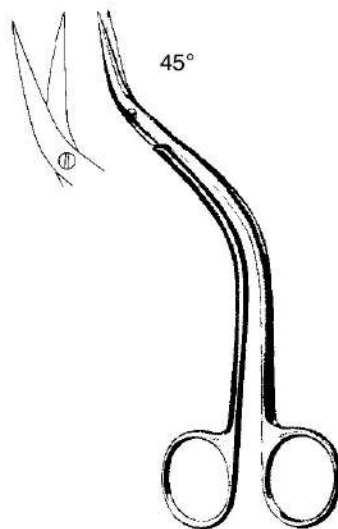
POTTS-SMITH  
 19 cm, 7 1/2"



DE BAKEY



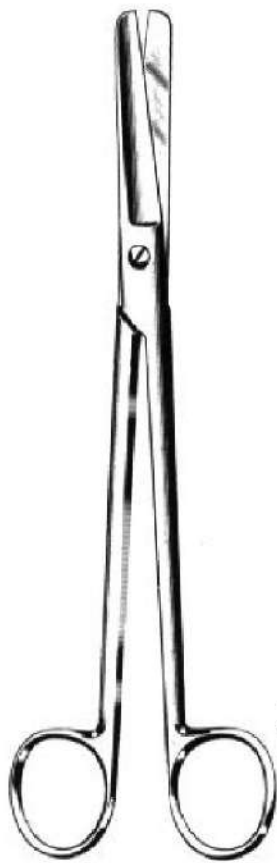
FAVALORO  
 EV09496-15      15 cm, 6"



DE BAKEY  
 EV09497-15      15,5 cm, 6"



KELLY  
 EV09540-16  
 EV09541-16 EV09542-16 TC  
 EV09543-16 TC  
 16 cm, 6 1/4"



SIMS  
 EV09510-20 20 cm, 8" EV09511-20  
 EV09510-23 23 cm, 9"  
 EV09511-23



EV09512-20  
 EV09512-23



EV09513-20  
 EV09513-23



EV09514-20  
 EV09514-23



EV09515-20  
 EV09515-23

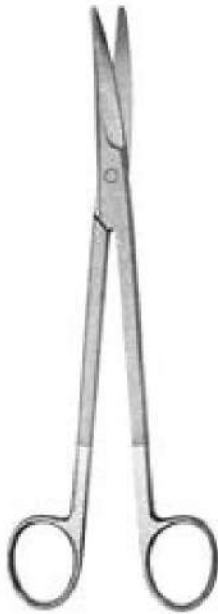


SIEBOLD EV  
 EV09523-24 24 cm, 9 1/2"

EV09516-23 TC 23 cm, 9" EV09517-23 TC



Parametriumscheren - Parametrium scissors - Parametrium nasales - Parametrium nasali



ELGEN



EV09501-23 23 cm, 9"  
 EV09505-23 TC 23 cm, 9"  
 EV09505-26 TC 26 cm, 10 1/4"  
 EV09505-30 TC 30 cm, 12"



EV09501-22 22,5 cm, 8.9"  
 EV09507-23 TC 23 cm, 9"  
 EV09507-26 TC 26 cm, 10 1/4"  
 EV09507-30 TC 30 cm, 12"



WERTHEIM

EV09525-22 22,5 cm, 8.9"



DOYEN

EV09530-17 EV09531-17  
 17,5 cm, 6.9"



DUBOIS

EV09536-27 EV09537-27  
 27 cm, 10 1/2"

Episiotomiescheren, Nabelschnurscheren  
Episiotomy Scissors, Umbilical Scissors  
Tijeras para episiotomía, Tijeras umbilicales  
Forbici per episiotomia, Forbici ombelicali

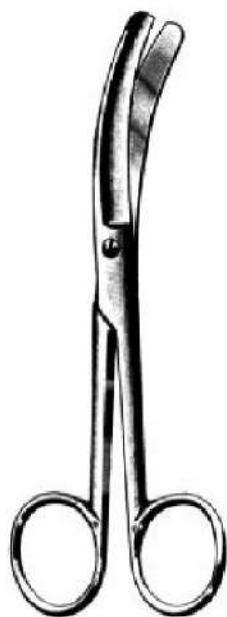


gezahnt  
saw edge  
dentadas  
dentellata

WALDMANN  
EV09548-18  
18 cm, 7"



U.S.A. Mod.  
EV09550-10  
10,5 cm, 4"



BUSCH  
EV09551-16  
16 cm, 6 1/4"



SCHUMACHER  
EV09553-16  
16 cm, 6 1/4"

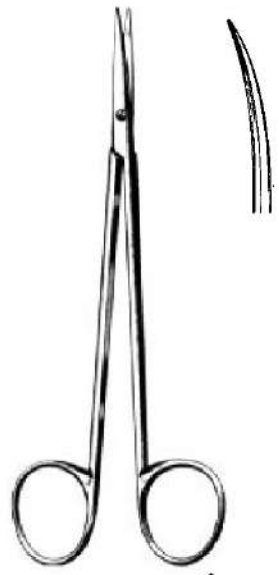


BRAUN-STADLER  
EV09560-14 14,5 cm, 5 3/4"  
EV09560-22 22,0 cm, 8 3/4"

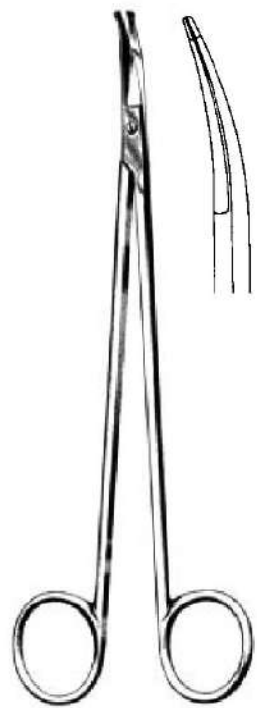
Neurochirurgische Scheren, Gefäßschere, Präparierscheren  
 Neurosurgical Scissors, Vascular Scissors, Dissecting Scissors  
 Tijera para neurocirugía, Tijeras vasculares, Tijeras de disección  
 Forbici per neurochirurgia, Forbici vascolari, Forbici per preparazione



EV09580-11 EV09581-11  
 11 cm, 4 3/8"



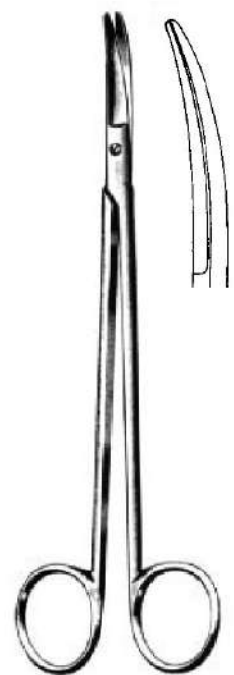
EV09582-15 EV09583-15  
 15 cm, 6"



STRULLY  
 EV09601-22  
 22 cm, 8 3/4"



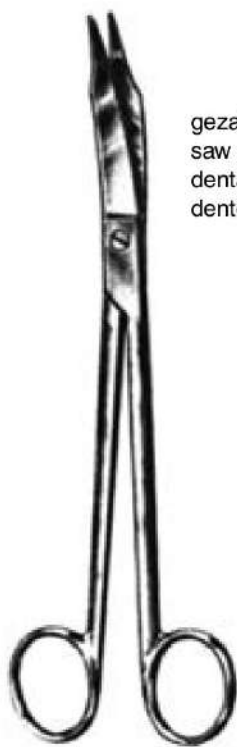
TOENNIS-ADSON  
 EV09610-18  
 18 cm, 7"



TOENNIS-ADSON  
 EV09611-18  
 18 cm, 7"

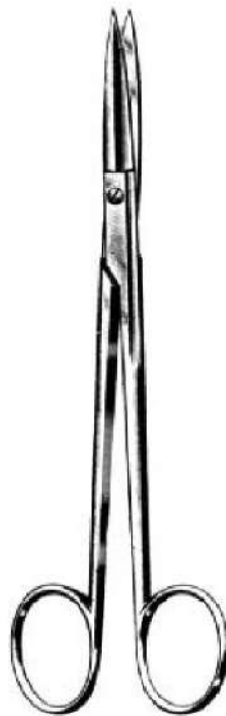


Knorpelscheren, Nasenschere, Gefäßscheren  
 Cartilage Scissors, Nasel Scissors, Vascular Scissors  
 Tijeras para cartilago, Tijeras nasales, Tijeras vasculares  
 Forbici per cartilagene, Forbici nasali, Forbici vascolari



gezahnt  
 saw edge  
 dentadas  
 dentellata

MARTIN  
 EV09613-20  
 20 cm, 8"



McINDOE  
 EV09614-19  
 19 cm, 7 1/2"



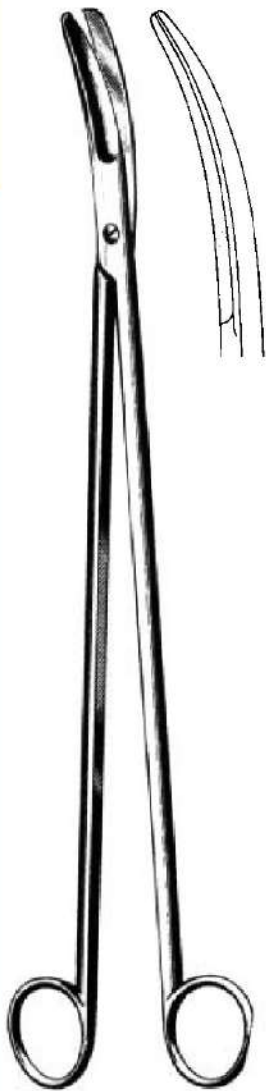
FOMON  
 EV09617-13  
 13 cm, 5 1/8"



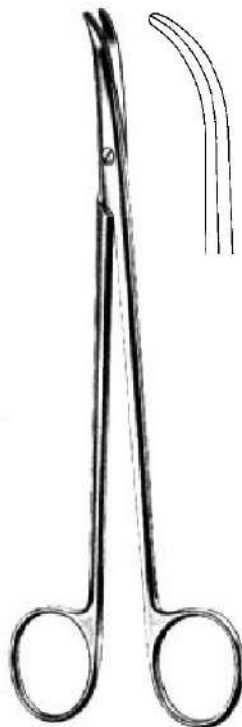
SCHMIEDEN-TAYLOR  
 EV09619-17  
 17 cm, 6 3/4"



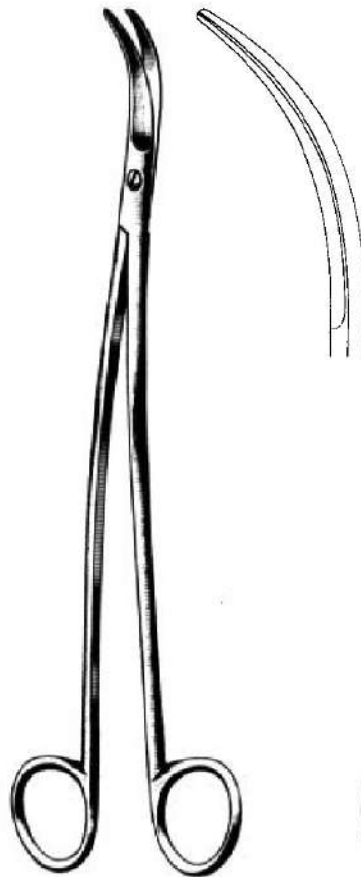
Gefäßscheren, Präparierscheren  
 Vascular Scissors, Dissecting Scissors  
 Tijeras vasculares, Tijeras de disección  
 Forbici vascolari, Forbici per preparazione



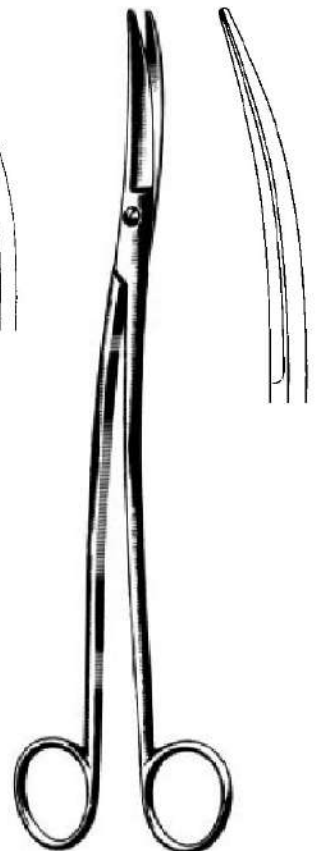
CRAFOORD  
 EV09641-30  
 30 cm, 11 3/4"



THOREK  
 EV09643-19 19 cm, 7 1/2"  
 EV09643-25 25 cm, 10"



SATINSKY  
 EV09651-24  
 24,5 cm, 9 1/2"



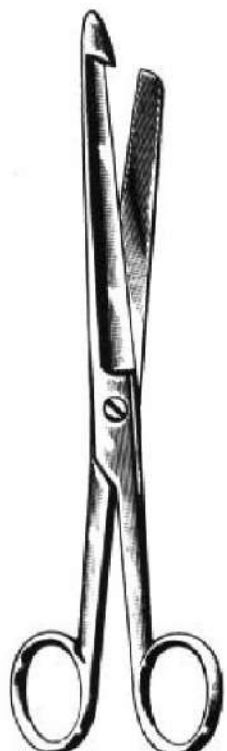
KLINKENBERGH-LOTH  
 EV09661-23  
 23 cm, 9"



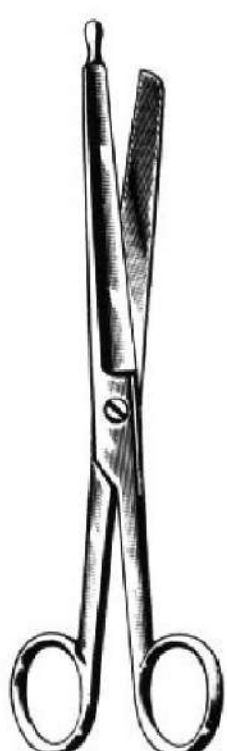
Darmscheren, Nagelspaltschere, Fadenscheren  
 Enterotomy Scissors, Nail Splitting Scissors, Stitch Scissors  
 Tijeras para intestino, Tijeras para hender uña, Tijeras para hilos  
 Forbici per enterotomia, Forbici per staccare unghie, Forbici per legature



FERGUSSON  
 EV09770-18  
 18 cm, 7"



EV09772-21  
 21 cm, 8 1/4"



EV09774-21  
 21 cm, 8 1/4"



SYSTRUNK  
 EV09775-13 EV09777-13  
 13 cm, 5 1/8"



SPENCER  
 EV09802-09  
 9 cm, 3 1/2"



SPENCER  
 EV09802-11  
 11 cm, 4 3/8"



NORTHBENT  
 EV09803-09 9 cm, 3 1/2"  
 EV09803-13 13 cm, 5 1/8"



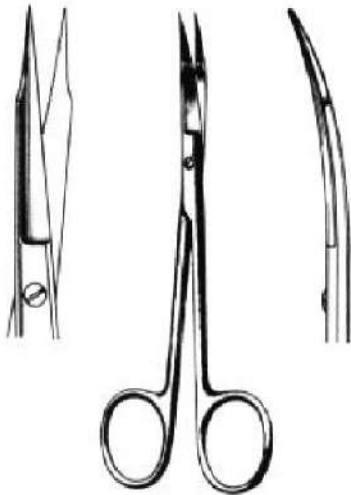
LITTAUER  
 EV09804-14  
 14 cm, 5 1/2"



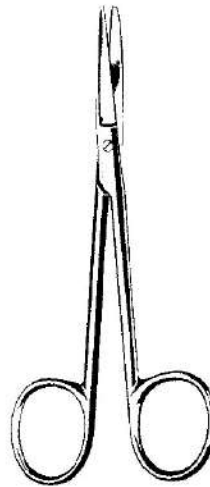
HEATH  
 EV09809-15  
 15 cm, 6"

Zahnfleischscheren, feine Scheren, Drahtschere  
 Gum Scissors, Delicate Scissors, Wire Cutting Scissors  
 Tijeras para encías, Tijeras finas, Tijeras para alambre  
 Forbici per gengiva, Forbici delicate, Forbici per filo di metallo

1 Schneide gezahnt  
 1 blade toothed  
 1 hoja dentada  
 1 taglio della lama dentellato



**GOLDMAN-FOX**  
 EV09820-13 13 cm, 5 1/8" EV09821-13



**WAGNER**  
 12 cm, 4 3/4"

gerade  
 straight  
 rectas  
 rette



Fig. 1

EV09828-12



Fig. 2

EV09826-12



Fig. 3

EV09824-12

gebogen  
 curved  
 curvas  
 curve



Fig. 1

EV09823-12



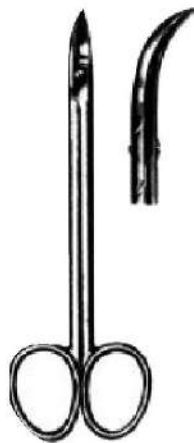
Fig. 2

EV09829-12



Fig. 3

EV09825-12



**QUINBY**  
 EV09827-12 12 cm, 4 3/4"



**UNIVERSAL**  
 EV09831-12 12 cm, 4 3/4"  
 EV09835-12 TC 12 cm, 4 3/4"

Kronenscheren  
Crown Scissors  
Tijeras para coronas  
Forbici per corona



EV09850-10  
gerade spitz  
straight pointed  
rectas agudas  
rette acute

EV09851-10  
gebogen spitz  
curved pointed  
curvas agudas  
curve acute

BEEBEE  
10,5 cm, 4"



Zahnfleischscheren  
 Gum Scissors  
 Tijeras para encias  
 Forbici per gengiva



LA GRANGE  
 EV09854-11  
 11,5 cm, 4 1/2"



gezahnt  
 saw edge  
 dentadas  
 dentellata

LOCKLIN  
 EV09859-16  
 16 cm, 6 1/4"



gezahnt  
 saw edge  
 dentadas  
 dentellata

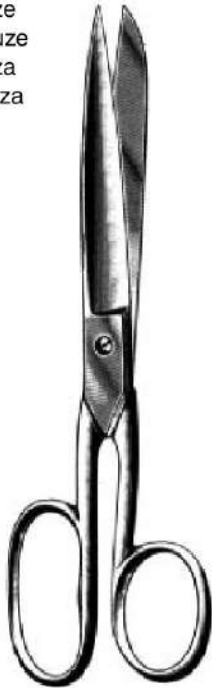
LOCKLIN  
 EV09860-16  
 16,5 cm , 6 1/2"



LOCKLIN  
 EV09861-16 TC  
 16,5 cm, 6 1/2"

Verbandscheren, Gipsschere  
 Bandage Scissors, Plaster Scissors  
 Tijeras para vendajes, Tijeras para yeso  
 Forbici per bendaggi, Forbici per gesso

Gaze  
 Gauze  
 Gaza  
 Garza



SMITH US ARMY  
 EV09898-20  
 20 cm, 8"



LISTER 9 cm, 3 1/2"  
 EV09901-09 11 cm, 4 3/8"  
 EV09901-11 14 cm, 5 1/2"  
 EV09901-14  
 18 cm, 7" EV09901-18  
 20 cm, 8" EV09901-20

EV09905-14 TC  
 EV09905-18 TC



LISTER  
 EV09906-18 18 cm, 7"  
 EV09906-20 20 cm, 8"



BERGMANN  
 EV09911-23  
 23 cm, 9"

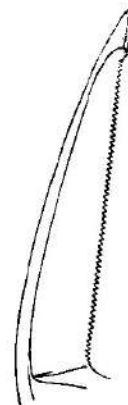
Gipsscheren, Verbandscheren  
 Plaster Scissors, Bandage Scissors  
 Tijeras para yeso, Tijeras para vendajes  
 Forbici per gesso, Forbici per bendaggi



ESMARCH  
 EV09913-20 20 cm, 8"  
 EV09913-22 22 cm, 8 3/4"



SEUTIN  
 EV09915-23  
 23 cm, 9"



gezahnt  
 toothed  
 dentadas  
 dentellata

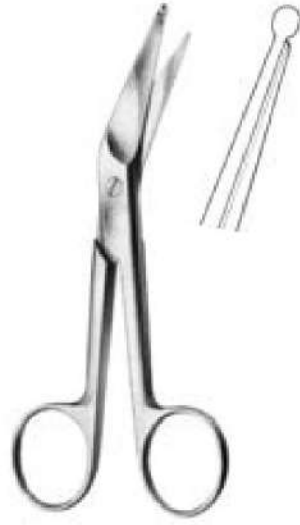
ELGEN EXCENTER  
 EV09921-16 16 cm, 6 1/4"  
 EV09921-19 19 cm, 7 1/2"



Verbandscheren, Gipsschere  
 Bandage Scissors, Plaster Scissors  
 Tijeras para vendajes, Tijeras para yeso  
 Forbici per bendaggi, Forbici per gesso



KNOWLES  
 EV09930-14  
 14 cm, 5 1/2"



KNOWLES  
 EV09931-14  
 14 cm, 5 1/2"



LORENZ  
 EV09933-23  
 23 cm, 9"



BRUNS  
 EV09935-23 23 cm, 9"  
**EV09939-23 TC** EV09937-23  
 23 cm, 9"



EV09941-20  
 20 cm, 8"

in verschiedenen Farben lieferbar  
 in different colours available  
 en diferentes colores disponibles  
 in differenti colori disponibile



UNIVERSAL  
 EV09950-15 15 cm, 6"  
 EV09950-18 18 cm, 7"

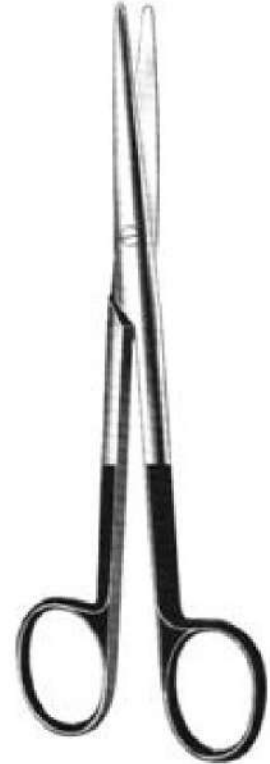
Supercut Scheren, gezahnt  
 Supercut Scissors, saw edge  
 Tijeras Supercut, dentadas  
 Forbici Supercut, dentellate



EV09960-14 EV09961-14  
 14,5 cm, 5 3/4"



MAYO  
 EV09962-14 14,5 cm EV09963-14  
 EV09962-17 17,0 cm EV09963-17  
 EV09962-23 23,0 cm EV09963-23



MAYO-STILLE  
 EV09964-15 15,0 cm EV09965-15  
 EV09964-17 17,0 cm EV09965-17



BABY METZENBAUM  
 EV09966-11 EV09967-11  
 11,5 cm, 4 1/2"



METZENBAUM  
 EV09970-14 14,5 cm EV09971-14  
 EV09970-18 18,0 cm EV09971-18  
 EV09970-20 20,0 cm EV09971-20  
 EV09970-23 23,0 cm EV09971-23

Supercut Scheren, gezahnt  
 Supercut Scissors, saw edge  
 Tijeras Supercut, dentadas  
 Forbici Supercut, dentellate



IRIS  
 EV09980-11 EV09981-11  
 11,5 cm, 4 1/2"



WAGNER  
 EV09982-12 EV09983-12  
 12 cm, 4 3/4"



STEVENS  
 EV09984-11 EV09985-11  
 11,5 cm, 4 1/2"



LaGrange  
 EV09986-11 11,5 cm, 4 1/2"



LISTER  
 EV09990-14 14,5 cm, 5 3/4"  
 EV09990-18 18,0 cm, 7"



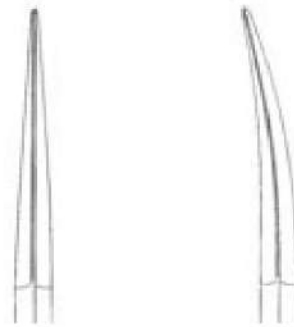
REYNOLDS  
 EV09993-15 15 cm, 6"  
 EV09993-18 18 cm, 7"



KILNER/RAGNELL  
 EV09995-12 12 cm, 4 3/4"



GORNEY  
19 cm, 7 1/2"



- |                     |                     |
|---------------------|---------------------|
| EV10010-19          | EV10011-19          |
| EV10012-19 TC       | EV10013-19 TC       |
| EV10014-19 Supercut | EV10015-19 Supercut |



REES

- |                            |            |
|----------------------------|------------|
| EV10016-17 17,0 cm, 6 3/4" | EV10017-17 |
| EV10018-20 20,5 cm, 8"     | EV10019-20 |
| TC                         |            |
| EV10020-17 17,0 cm, 6 3/4" | EV10021-17 |
| EV10022-20 20,5 cm, 8"     | EV10023-20 |
| Supercut                   |            |
| EV10024-17 17,0 cm, 6 3/4" | EV10025-17 |
| EV10026-20 20,5 cm, 8"     | EV10027-20 |



KAYE

- |                            |            |
|----------------------------|------------|
| TC                         |            |
| EV10028-14 14,5 cm, 5 3/4" | EV10029-14 |
| EV10030-18 18,5 cm, 7 1/4" | EV10031-18 |
| EV10032-23 23,0 cm, 9"     | EV10033-23 |
| Supercut                   |            |
| EV10034-14 14,5 cm, 5 3/4" | EV10035-14 |
| EV10036-18 18,5 cm, 7 1/4" | EV10037-18 |
| EV10038-23 23,0 cm, 9"     | EV10039-23 |

Face-Lift-Scheren  
Face-Lift-Scissors  
Tijeras para Face-Lift  
Forbici per Face-Lift



EV10040-18  
EV10041-18 TC  
EV10042-18 Supercut

FREEMAN  
18 cm, 7"



EV10044-14  
EV10046-14 TC  
EV10048-14 Supercut  
EV10045-14  
EV10047-14 TC  
EV10049-14  
Supercut

PECK JOSEPH  
14,5 cm, 5 3/4"



Augenscheren  
Ophthalmic Scissors  
Tijeras oculares  
Forbici oculistiche



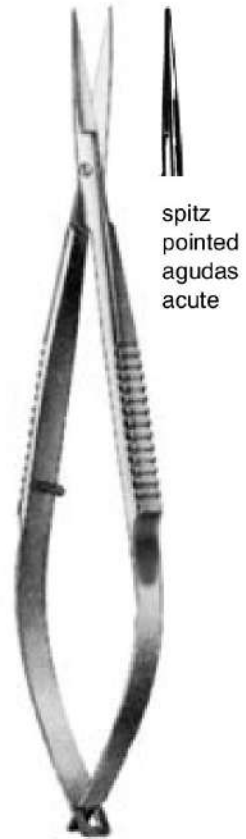
spitz  
pointed  
agudas  
acute

WESTCOTT  
EV10102-11  
11 cm, 4 3/8"



stumpf  
blunt  
romas  
smusse

WESTCOTT  
EV10104-11  
11 cm, 4 3/8"



spitz  
pointed  
agudas  
acute

NOYES  
EV10110-12 EV10111-12  
12 cm, 4 3/4"



WECKER  
11 cm, 4 3/8"



EV10113-11

spitz  
pointed  
agudas  
acute



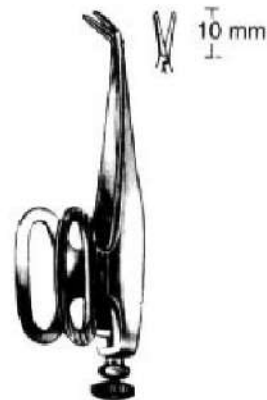
EV10115-11

spitz / stumpf  
pointed / blunt  
agudas / romas  
acute / smusse



EV10117-11

stumpf  
blunt  
romas  
smusse



BARRAQUER  
EV10119-10 5,5 cm,  
2.2" (Colibri)

Mikro-Scheren  
Micro-Scissors  
Micro-Tijeras  
Micro-Forbici



EV10120-16  
EV10120-18  
EV10120-22

16,0 cm, 6 1/4"  
18,5 cm, 7 1/4"  
22,5 cm, 8.9"



EV10121-16  
EV10121-18  
EV10121-22



EV10122-16  
EV10122-18  
EV10122-22

16,0 cm, 6 1/4"  
18,5 cm, 7 1/4"  
22,5 cm, 8.9"



EV10123-16  
EV10123-18  
EV10123-22



EV10124-16  
EV10124-18  
EV10124-22

16,0 cm, 6 1/4"  
18,5 cm, 7 1/4"  
22,5 cm, 8.9"



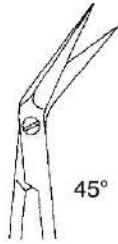
EV10125-16  
EV10125-18  
EV10125-22

Circumflex



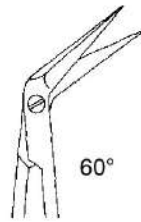
25°

EV10126-25



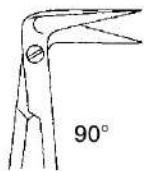
45°

1EV0126-45



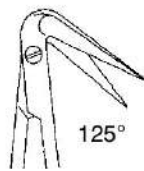
60°

EV10126-60



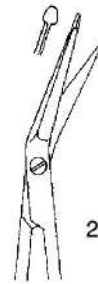
90°

EV10126-90



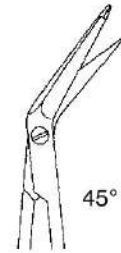
125°

EV10126-00



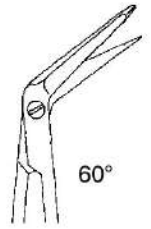
25°

EV10127-25



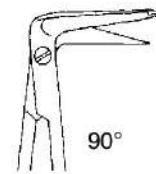
45°

EV10127-45



60°

EV10127-60



90°

EV10127-90



125°

EV10127-00



ELGEN  
18 cm, 7"

Mikro-Scheren  
Micro-Scissors  
Micro-Tijeras  
Micro-Forbici



EV10128-09  
9 cm, 3 1/2"



EV10128-15 - EV10130-15  
15 cm, 6"

EV10128-15  
gerade  
straight  
rectas  
rette

EV10129-15  
gebogen  
curved  
curvas  
curvo

EV10130-15  
gebogen, 1 Schneide gezahnt  
curved, 1 blade toothed  
curvas, 1 hoja dentada  
curva, 1 lama dentellata

halbscharf  
semi-sharp  
medio roma  
lame semi smusse



HEPP-SCHEIDEL  
EV10131-14 14 cm, 5 1/2"  
EV10131-18 18 cm, 7"



HEPP-SCHEIDEL  
EV10132-18  
18 cm, 7"



HEPP-SCHEIDEL  
EV10137-01  
18 cm, 7"  
spitz  
pointed  
agudas  
acute

HEPP-SCHEIDEL  
EV10137-02  
18 cm, 7"  
stumpf  
blunt  
romas  
smusse

Iridektomie, Iridectomy, Iridectomía, iridectomia

Augen-, Mikroscheren  
Ophthalmic, Micro Scissors  
Tijeras oculares, micro tijeras  
Forbici oculistiche, micro chirurg.



EV10142-08  
kniegebogen  
angular  
acodada  
angolate



EV10143-08  
aufgewinkelt  
angled up  
acodada hacia arriba  
angolate verso l'alto

CASTROVIEJO  
EV10133-10 10 cm, 4"

CASTROVIEJO  
EV10135-10 10 cm, 4"

VANNAS EV10140-08  
8 cm, 3 1/8"

VANNAS  
EV10141-08 8 cm, 3 1/8"

Hornhautscheren, Corneal scissors, Tijeras corneales, Forbici corneali



CASTROVIEJO  
EV10151-11 11 cm, 4 3/8"

CASTROVIEJO  
EV10153-11 11 cm, 4 3/8"

CASTROVIEJO  
EV10155-11 11 cm, 4 3/8"

Mikro-Scheren  
 Micro-Scissors  
 Micro-Tijeras  
 Micro-Forbici



ELGEN  
 EV10202-18 -  
 10203-18 18 cm, 7"

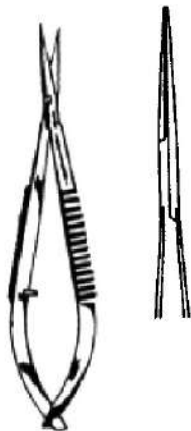


EV10313-14  
 14 cm  
 5 1/2"



EV10313-16  
 16 cm  
 6 1/4"

GOMEL



ELGEN micro  
 EV10320-09  
 9 cm, 3 1/2"



EV10330-19



EV10331-19



EV10333-19

ELGEN  
 EV10330-19 - EV10333-19  
 18,5 cm, 7 1/4"

Anatomische und chirurgische Pinzetten  
 Dressing and Tissue Forceps  
 Pinzas de disección, sin/con dientes  
 Pinze per dissezione, chirurgiche/anatomiche

STANDARD



USA

STILLE

| cm   |        |            |            |            |
|------|--------|------------|------------|------------|
| 10,5 | 4 1/4" | EV11102-10 |            |            |
| 11,5 | 4 1/2" | EV11102-11 |            |            |
| 12,0 | 4 3/4" |            |            | EV11104-12 |
| 13,0 | 5 1/8" | EV11102-13 |            | EV11104-13 |
| 14,5 | 5 3/4" | EV11102-14 | EV11103-14 | EV11104-14 |
| 15,0 | 6"     |            |            | EV11104-15 |
| 16,0 | 6 1/4" | EV11102-16 |            |            |
| 18,0 | 7"     | EV11102-18 |            | EV11104-18 |
| 20,0 | 8"     | EV11102-20 |            |            |
| 21,0 | 8 1/4" |            |            | EV11104-21 |
| 25,0 | 10"    | EV11102-25 |            | EV11104-25 |
| 30,0 | 12"    | EV11102-30 |            |            |

schmal  
 narrow  
 estrecha  
 stretta



POTTS-SMITH

POTTS-SMITH  
 1x2

| cm   |        |            |               |               |
|------|--------|------------|---------------|---------------|
| 11,5 | 4 1/2" | EV11110-11 |               |               |
| 13,0 | 5 1/8" | EV11110-13 |               |               |
| 14,5 | 5 3/4" | EV11110-14 | EV11114-14 TC |               |
| 16,0 | 6 1/4" | EV11110-16 | EV11114-16 TC |               |
| 18,0 | 7"     | EV11110-18 |               | EV11112-18    |
| 20,0 | 8"     | EV11110-20 | EV11114-20 TC | EV11116-18 TC |
| 21,0 | 8 1/4" |            |               | EV11112-21    |
| 25,0 | 10"    | EV11110-25 | EV11114-25 TC | EV11116-21 TC |
| 30,0 | 12"    | EV11110-30 |               | EV11116-25 TC |

Chirurgische Pinzetten  
Tissue Forceps  
Pinzas de disección, con dientes  
Pinze per dissezione, chirurgiche

| STANDARD | 1x2    | USA        | 1x2        | STILLE     | 1x2 | schmal<br>narrow<br>estrecha<br>stretta | 1x2        |
|----------|--------|------------|------------|------------|-----|---|------------|
| 10,5     | 4 1/4" | EV11120-10 |            |            |     |   |            |
| 11,5     | 4 1/2" | EV11120-11 |            |            |     |   | EV11130-11 |
| 12,0     | 4 3/4" |            | EV11122-12 |            |     |   |            |
| 13,0     | 5 1/8" | EV11120-13 | EV11122-13 |            |     |   | EV11130-13 |
| 14,5     | 5 3/4" | EV11120-14 | EV11122-14 |            |     |   | EV11130-14 |
| 15,0     | 6"     |            |            | EV11124-15 |     |   |            |
| 15,5     | 6"     |            | EV11122-15 |            |     |   |            |
| 16,0     | 6 1/4" | EV11120-16 |            |            |     |   | EV11130-16 |
| 18,0     | 7"     | EV11120-18 | EV11122-18 |            |     |   | EV11130-18 |
| 20,0     | 8"     | EV11120-20 |            |            |     |   | EV11130-20 |
| 21,0     | 8 1/4" |            | EV11122-21 |            |     |   |            |
| 25,0     | 10"    | EV11120-25 | EV11122-25 |            |     |   |            |
| 30,0     | 12"    | EV11120-30 |            |            |     |   |            |

|      | 1x2           | 2x3        | 3x4        | 4x5        |
|------|---------------|------------|------------|------------|
| cm   |               |            |            |            |
| 11,5 | 4 1/2"        |            |            |            |
| 13,0 | 5 1/8"        |            |            |            |
| 14,5 | 5 3/4"        |            |            |            |
| 16,0 | 6 1/4"        | EV11140-11 | EV11150-13 | EV11160-13 |
| 18,0 | 7"            | EV11140-13 | EV11150-14 | EV11160-14 |
| 20,0 | 8"            | EV11140-14 | EV11150-16 | EV11160-16 |
| 25,0 | 10"           | EV11140-16 |            |            |
| 30,0 | 12"           | EV11140-18 |            |            |
|      | EV11132-16 TC | EV11140-20 |            |            |
|      | EV11132-18 TC | EV11140-25 |            |            |
|      | EV11132-20 TC |            |            |            |
|      | EV11132-25 TC |            |            |            |
|      | EV11132-30 TC |            |            |            |



Anatomische und chirurgische Pinzetten  
 Dressing and Tissue Forceps  
 Pinzas de disección, sin/con dientes  
 Pinze per dissezione, chirurgiche/anatomiche



ADSON  
 EV11170-12 12,0 cm, 4 3/4"  
 EV11170-15 15,0 cm, 6"



ADSON  
 EV11174-12 TC 12,0 cm, 4 3/4"  
 EV11174-15 TC 15,0 cm, 6"



ADSON micro  
 EV11176-12 12,0 cm, 4 3/4"  
 EV11176-15 15,0 cm, 6"



ADSON-DEBAKEY atraumatic  
 EV11177-12  
 12,0 cm, 4 3/4"



ADSON  
 EV11178-12  
 12,0 cm, 4 3/4"



ADSON  
 EV11179-12  
 12 cm, 4 3/4"

Anatomische und chirurgische Pinzetten  
 Dressing and Tissue Forceps  
 Pinzas de disección, sin/con dientes  
 Pinze per dissezione, anatomiche/chirurgiche



1x2

ADSON

EV11180-12 12,0 cm, 4 3/4"  
 EV11180-15 15,0 cm, 6"



1x2

ADSON

EV11181-12 TC 12,0 cm, 4 3/4"  
 EV11181-15 TC 15,0 cm, 6"



1x2

ADSON micro

EV11186-12 12,0 cm, 4 3/4"  
 EV11186-15 15,0 cm, 6"



1x2

ADSON

EV11187-12  
 12 cm, 4 3/4"



7x7

ADSON-BROWN

EV11188-12 12,0 cm, 4 3/4"  
 EV11188-15 15,0 cm, 6"  
 EV11189-12 TC 12,0 cm, 4 3/4"

Anatomische und chirurgische Pinzetten  
 Dressing and Tissue Forceps  
 Pinzas de disección, sin/con dientes  
 Pinze per dissezione, chirurgiche/anatomiche



**BROWN**  
 EV11189-15 15,0 cm, 6"  
 EV11189-20 20,0 cm, 8"  
 EV11189-25 25,0 cm, 10"



**GRAEFE**  
 EV11190-10 10,5 cm, 4.1"



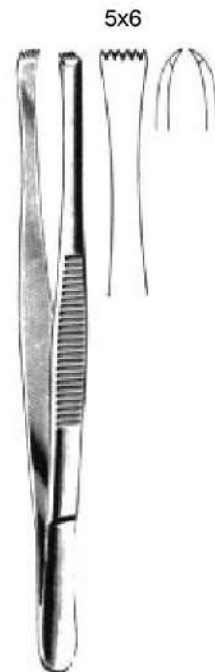
**WAUGH**  
 EV11187-18 18 cm, 7"  
 EV11187-20 20 cm, 8"  
 EV11187-25 25 cm, 10"  
 EV11187-30 30 cm, 11 3/4"



**CUSHING**  
 EV11220-17  
**EV11224-17 TC**  
 17,0 cm, 6 3/4"



**CUSHING**  
 EV11222-17  
**EV11225-17 TC**  
 17,0 cm, 6 3/4"

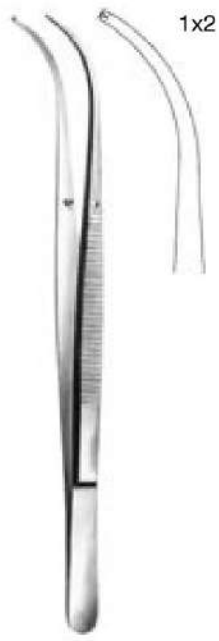


**LERCHE**  
 EV11232-15 15,0  
 cm, 6"

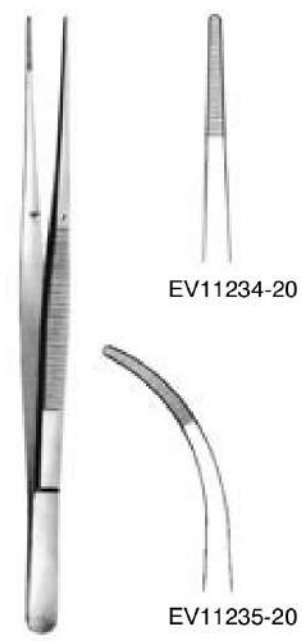
Anatomische und chirurgische Pinzetten, Faßpinzetten  
 Dressing and Tissue Forceps  
 Pinzas de disección, sin/con dientes  
 Pinze per dissezione, chirurgiche/anatomiche



BROPHY  
 EV11231-20  
 20,0 cm, 8"



BROPHY  
 EV11233-20  
 20,0 cm, 8"



BROPHY  
 20,0 cm, 8"



ADLERKREUTZ  
 EV11236-15 15,0 cm, 6"  
 EV11236-20 20,0 cm, 8"



DUEHRSEN  
 EV11237-20  
 20 cm, 8"



LANE  
 EV11240-14  
 14,5 cm, 5 3/4"

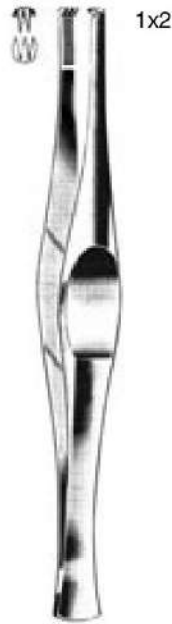


LANE  
 EV11242-14  
 14,5 cm, 5 3/4"

Anatomische und chirurgische Pinzetten, Faßpinzetten  
 Dressing and Tissue Forceps  
 Pinzas de disección, sin/con dientes  
 Pinze per dissezione, chirurgiche/anatomiche



FERRIS-SMITH  
 EV11246-18  
 18,0 cm, 7"



FERRIS-SMITH  
 EV11248-18  
 18,0 cm, 7"



DUVAL  
 EV11250-14  
 14,5 cm, 5 3/4"



COLLIN-DUVAL  
 EV11252-20  
 20,0 cm, 8"



Russ. Mod.  
 EV11256-15 15,0 cm, 6"  
 EV11256-20 20,0 cm, 8"  
 EV11256-25 25,0 cm, 10"



McINDOE  
 EV11257-15  
 15,0 cm, 6"



McINDOE  
 EV11258-15 15,0 cm, 6"  
 EV11259-15 TC 15,0 cm, 6"

Anatomische und chirurgische Pinzetten  
 Dressing and Tissue Forceps  
 Pinzas de disección, sin/con dientes  
 Pinze per dissezione, chirurgiche/anatomiche



SEMKEN  
 EV11260-12 12,5 cm, 5"  
 EV11260-15 15,5 cm, 6"  
 EV11261-15 TC 15,5 cm, 6"



1x2

SEMKEN  
 EV11270-12 12,5 cm, 5"  
 EV11270-15 15,5 cm, 6"  
 EV11271-15 TC 15,5 cm, 6"  
 EV11271-18 TC 18 cm, 7"



1x2

GILLIES  
 EV11272-15 15,5 cm, 6"  
 EV11273-15 TC 15,5 cm, 6"



15,5 cm, 6"



EV11274-06  
 0,6 mm



EV11274-08  
 0,8 mm



EV11274-10  
 1,0 mm



GERALD  
 EV11302-17 17,5 cm, 6.9"  
 EV11302-23 23,0 cm, 9"  
 EV11304-17 TC 17,0 cm, 6 3/4"



GERALD  
 EV11303-17 17,5 cm, 6.9"

Anatomische und chirurgische Pinzetten  
 Dressing and Tissue Forceps  
 Pinzas de disección, sin/con dientes  
 Pinze per dissezione, chirurgiche/anatomiche



GERALD  
 EV11305-17  
 17,5 cm, 6.9"



GERALD  
 EV11310-17 17,5 cm, 6.9"  
 EV11312-17 TC 17,5 cm, 6.9"



GERALD  
 EV11311-17  
 17,5 cm, 6.9"



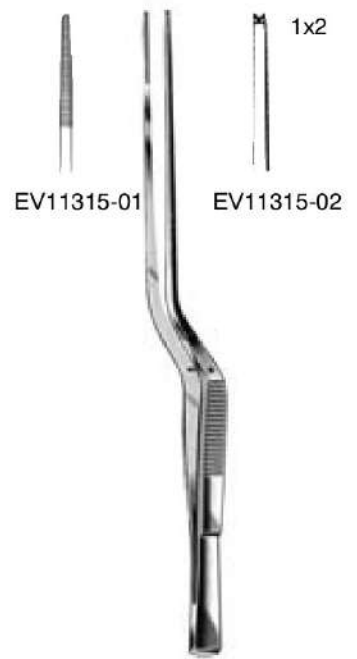
CUSHING-TAYLOR  
 EV11312-18 TC  
 18,5 cm, 7 1/4"



GERALD  
 EV11313-17  
 17,5 cm, 6.9"

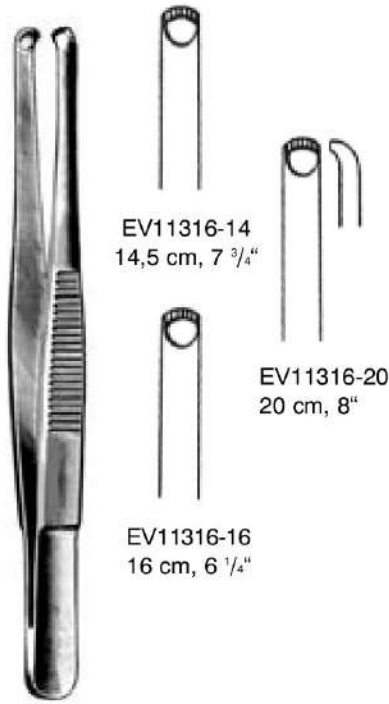


TAYLOR  
 17 cm, 6 3/4"



TAYLOR  
 17 cm, 6 3/4"

Anatomische und chirurgische Pinzetten  
 Dressing and Tissue Forceps  
 Pinzas de disección, sin/con dientes  
 Pinze per dissezione, chirurgiche/anatomiche

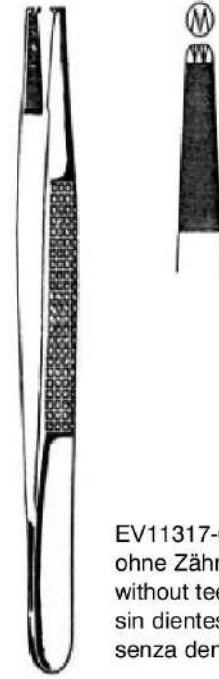


EV11316-14  
14,5 cm, 7 3/4"

EV11316-20  
20 cm, 8"

EV11316-16  
16 cm, 6 1/4"

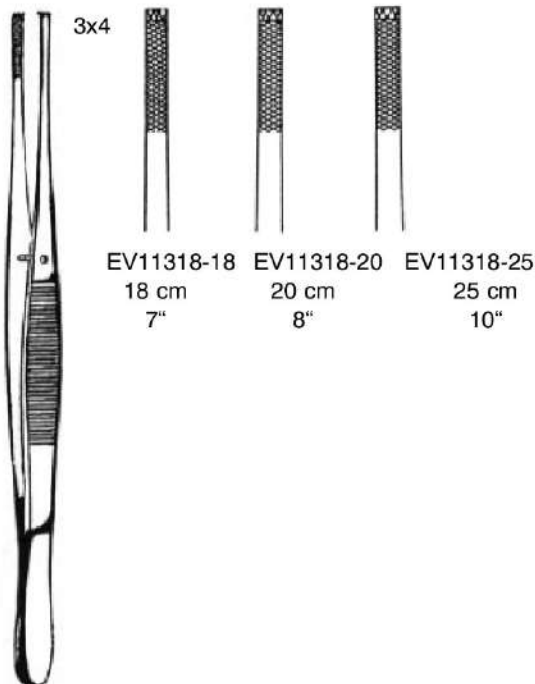
DURANTE



EV11317-00  
ohne Zähne  
without teeth  
sin dientes  
senza denti

EV11317-12 1x2  
EV11317-23 2x3  
EV11319-12 TC 1x2

BONNEY  
18 cm, 7"



3x4

EV11318-18  
18 cm  
7"

EV11318-20  
20 cm  
8"

EV11318-25  
25 cm  
10"

STILLE-BARRAYA



OCHSNER  
EV11319-14 14,5 cm 5 3/4"



SINGLEY  
EV11320-18 18 cm 7"  
EV11320-23 23 cm 9"



Anatomische und chirurgische Pinzetten  
 Dressing and Tissue Forceps  
 Pinzas de disección, sin/con dientes  
 Pinze per dissezione, chirurgiche/anatomiche



NELSON  
 EV11322-15 15 cm 6"  
 EV11322-18 18 cm 7"  
 EV11322-23 23 cm 9"



WANGENSTEEN  
 EV11324-23  
 23 cm 9"

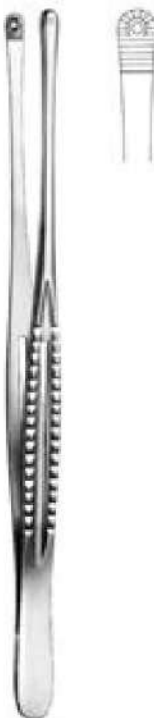


EV11325-15 TC  
 15 cm, 6"

EV11325-23 TC  
 23 cm, 9"

EV11325-25 TC  
 25 cm, 10"

WANGENSTEEN



MAYO EV11326-23  
 23 cm, 9"



STRASSBURGER  
 MODELL



1x2

1x2

EV11328-15  
 15 cm, 6"

EV11328-20  
 20 cm, 8"

Fig. 1



EV11401-01  
12 cm, 4 <sup>3</sup>/<sub>4</sub>"

Fig. 3



EV11403-03  
12 cm, 4 <sup>3</sup>/<sub>4</sub>"

Fig. 3c



EV11403-04  
11 cm, 4 <sup>3</sup>/<sub>8</sub>"

Fig. 4



EV11404-04  
11 cm, 4 <sup>3</sup>/<sub>8</sub>"

Fig. 5



EV11405-05  
11 cm, 4 <sup>3</sup>/<sub>8</sub>"

Fig. 7



EV11407-07  
12 cm, 4 <sup>3</sup>/<sub>4</sub>"

Splitterpinzetten  
Splinter Forceps  
Pinzas para espinas  
Pinze per schegge

GENERAL SURGICAL



EV11802-09 9,0 cm, 3 1/2"  
EV11802-10 10,5 cm, 4.1"  
EV11802-11 11,5 cm, 4 1/2"



FEILCHENFELD  
EV11810-07 7,5 cm, 3"  
EV11810-09 9,0 cm, 3 1/2"  
EV11810-11 11,5 cm, 4 1/2"



HUNTER  
EV11812-10 10,5 cm, 4.1"



HUNTER  
EV11813-10  
10,5 cm, 4.1"



HUNTER  
EV11815-12  
12,5 cm, 5"



CARMALT  
EV11816-10  
10,5 cm, 4.1"

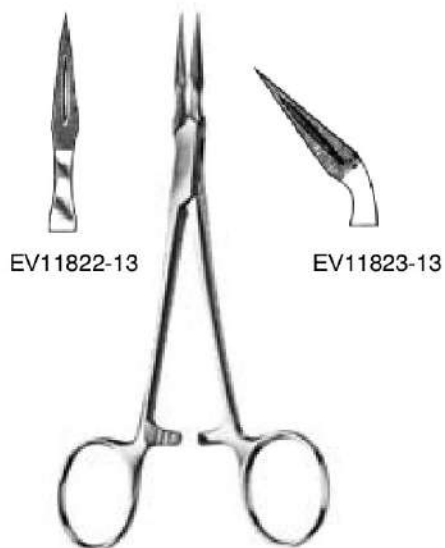


CARMALT  
EV11817-10  
10,5 cm, 4.1"

Splitterzangen  
Splinter Forceps  
Pinzas para espinas  
Pinze per schegge



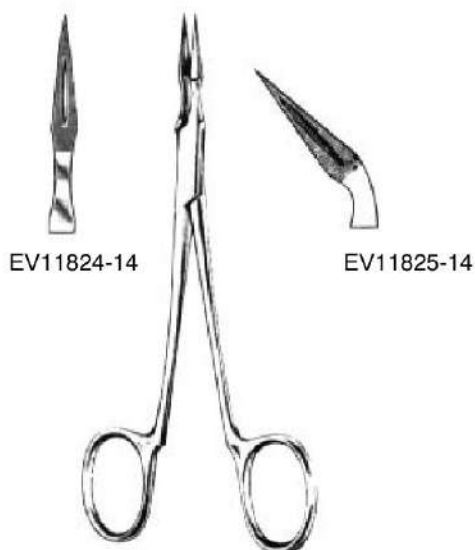
PEET  
EV11821-11  
11,5 cm, 4 1/2"



EV11822-13

EV11823-13

STIEGLITZ  
13,5 cm, 5 1/4"



EV11824-14

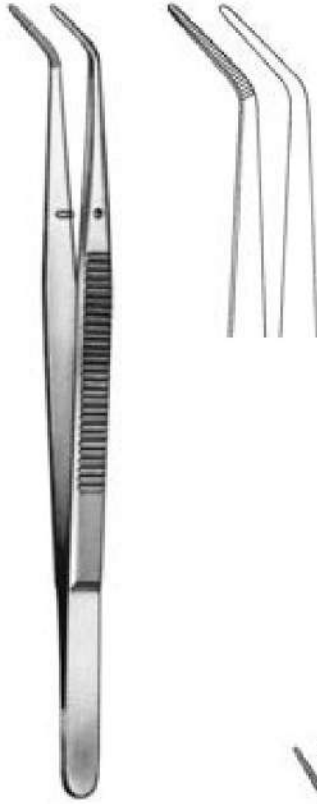
EV11825-14

ARCHER  
14 cm, 5 1/2"



VIRTUS (RALK)  
EV11828-15  
15 cm, 6"

Zahnpinzetten  
Dental Forceps  
Pinzas dentales  
Pinze dentali

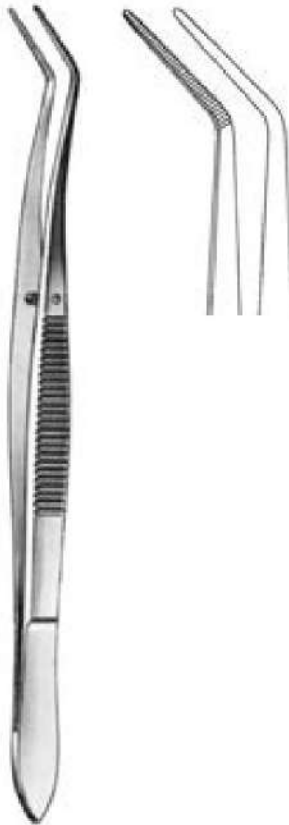


LONDON-COLLEGE  
EV11900-01  
15 cm, 6"



LONDON-COLLEGE  
EV11901-05  
15 cm, 6"

mit Sperre  
with lock  
con cierre  
con fermo



MERIAM  
EV11910-01  
15 cm, 6"

Mikrochirurgie-Pinzetten  
Microsurgery Forceps  
Pinzas para microcirugía  
Pinze per microchirurgia



EV12102-12  
12 cm, 4 3/4"



EV12103-12  
12 cm, 4 3/4"



EV12104-15  
15 cm, 6"



EV12105-15  
15 cm, 6"



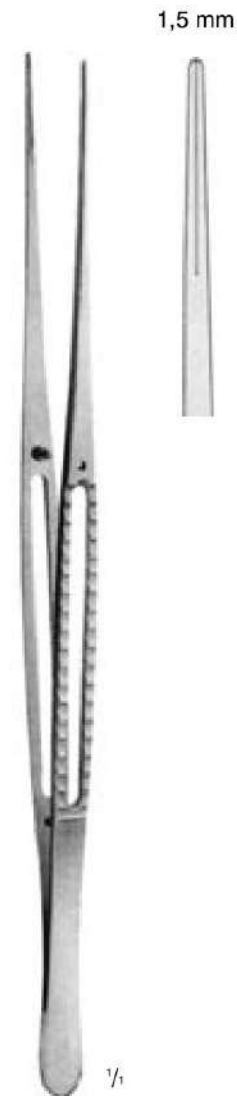
EV12108-18  
18 cm, 7"



EV12109-18  
18 cm, 7"



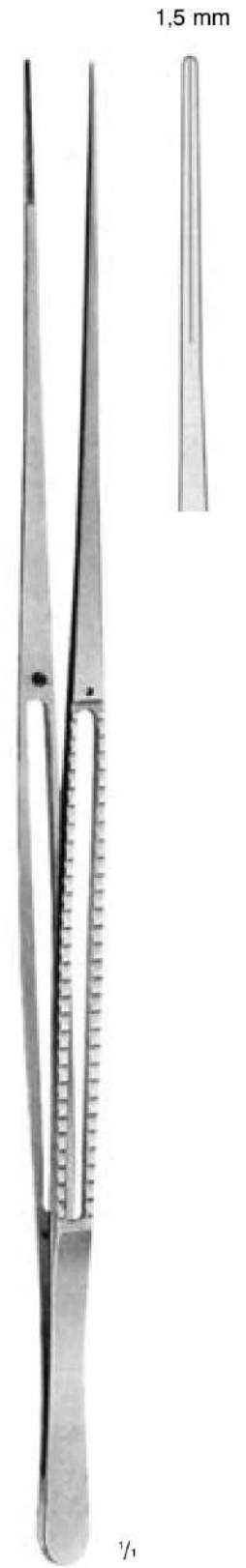
EV12110-15  
 15 cm, 6"



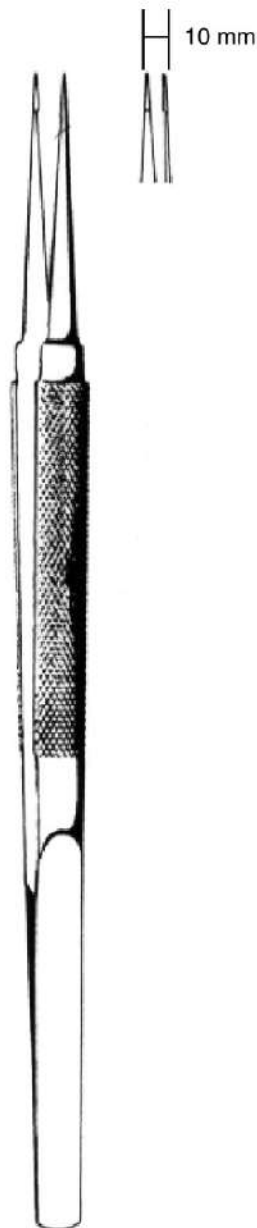
EV12110-20  
 20 cm, 8"



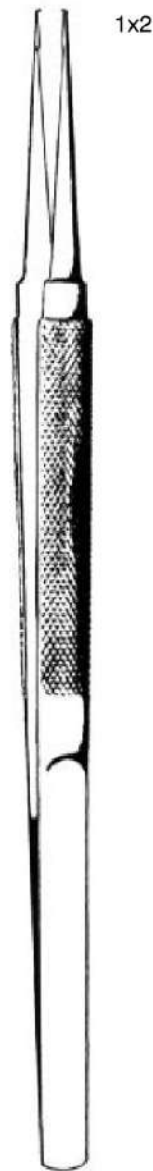
EV12110-24  
 24 cm, 9 1/2"



EV12110-30  
 30 cm, 11 3/4"



GOMEL  
EV12200-16  
16 cm, 6 1/4"



GOMEL  
EV12201-16  
16 cm, 6 1/4"



Tumorpinzetten  
Tumor forceps  
Pinzas para tumores  
Pinze per tumori



EV12291-22  
ø 3 mm



EV12293-22  
ø 5 mm



YASARGIL  
EV12295-22  
ø 3 mm



HUNT  
EV12297-22  
ø 5 mm



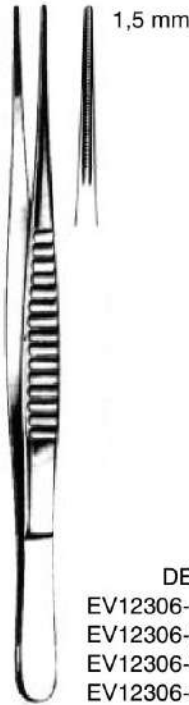
YASARGIL  
22 cm, 8 3/4"

22 cm, 8 3/4"

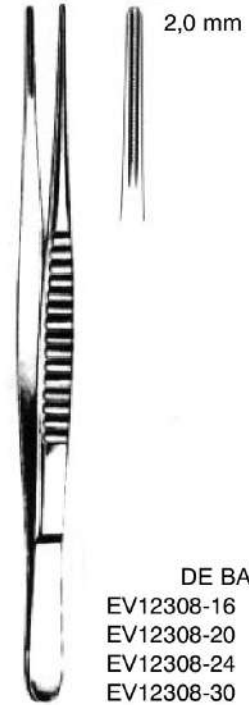
Atraumatische Pinzetten  
 Atraumatic Tissue Forceps  
 Pinzas atraumáticas  
 Pinze atraumatiche



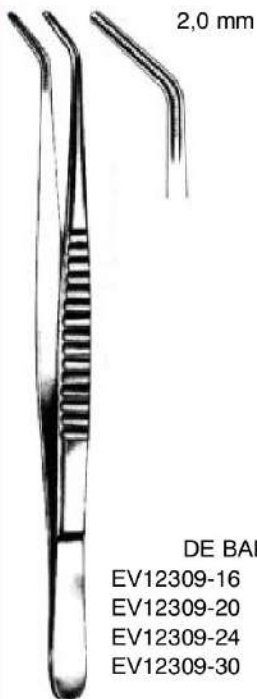
DE BAKLEY  
 EV12302-16 16 cm, 6 1/4"  
 EV12302-20 20 cm, 8"  
 EV12302-24 24 cm, 9 1/2"



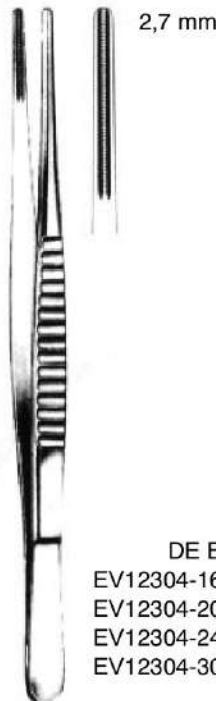
DE BAKLEY  
 EV12306-16 16 cm, 6 1/4"  
 EV12306-20 20 cm, 8"  
 EV12306-24 24 cm, 9 1/2"  
 EV12306-30 30 cm, 11 3/4"



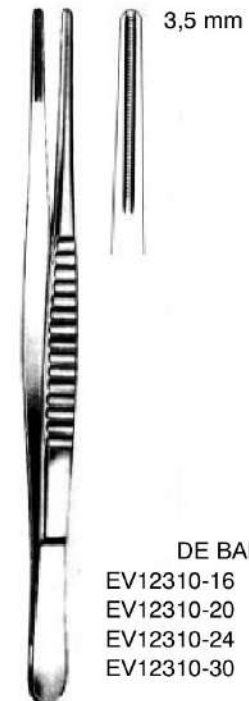
DE BAKLEY  
 EV12308-16 16 cm, 6 1/4"  
 EV12308-20 20 cm, 8"  
 EV12308-24 24 cm, 9 1/2"  
 EV12308-30 30 cm, 11 3/4"



DE BAKLEY  
 EV12309-16 16 cm, 6 1/4"  
 EV12309-20 20 cm, 8"  
 EV12309-24 24 cm, 9 1/2"  
 EV12309-30 30 cm, 11 3/4"

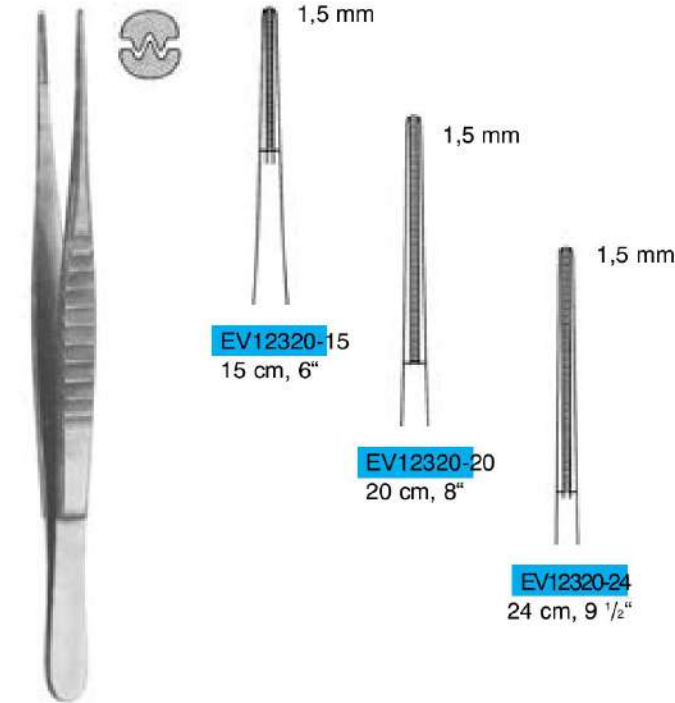


DE BAKLEY  
 EV12304-16 16 cm, 6 1/4"  
 EV12304-20 20 cm, 8"  
 EV12304-24 24 cm, 9 1/2"  
 EV12304-30 30 cm, 11 3/4"



DE BAKLEY  
 EV12310-16 16 cm, 6 1/4"  
 EV12310-20 20 cm, 8"  
 EV12310-24 24 cm, 9 1/2"  
 EV12310-30 30 cm, 11 3/4"

Atraumatische Pinzetten  
 Atraumatic Tissue Forceps  
 Pinzas atraumáticas  
 Pinze atraumatiche

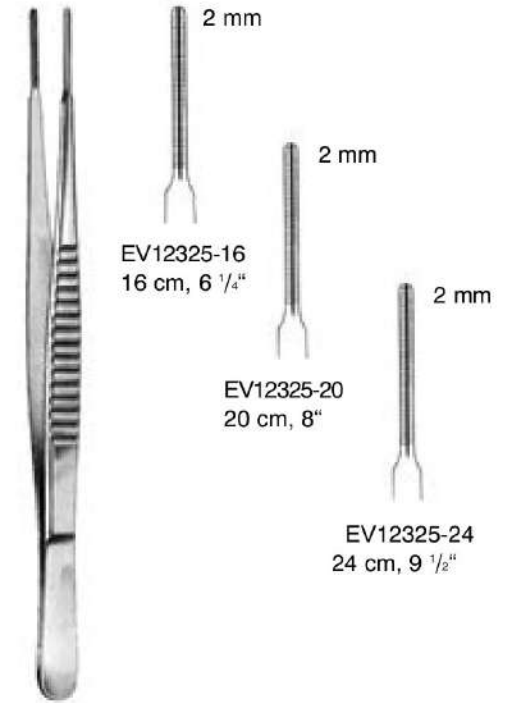


EV12320-15  
 15 cm, 6"

EV12320-20  
 20 cm, 8"

EV12320-24  
 24 cm, 9 1/2"

DE BAKEY  
 TITAN

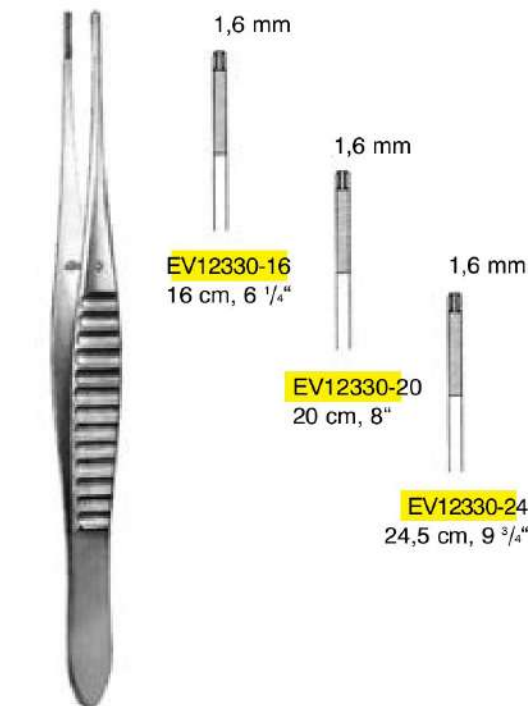


EV12325-16  
 16 cm, 6 1/4"

EV12325-20  
 20 cm, 8"

EV12325-24  
 24 cm, 9 1/2"

COOLEY

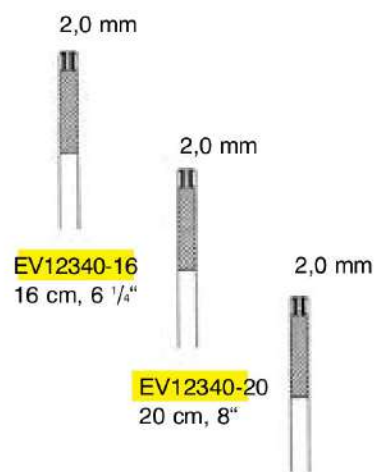


EV12330-16  
 16 cm, 6 1/4"

EV12330-20  
 20 cm, 8"

EV12330-24  
 24,5 cm, 9 3/4"

DE BAKEY TC



EV12340-16  
 16 cm, 6 1/4"

EV12340-20  
 20 cm, 8"

EV12340-24  
 24,5 cm, 9 3/4"

Atrauma-Bulldogklemmen  
 Atrauma-Bulldog Clamps  
 Clamps Atrauma Bulldog  
 Pinze Atrauma Bulldog



- EV13090-40  
40 mm / 1 1/2"
- EV13090-45  
45 mm / 1 3/4"
- EV13090-50  
50 mm / 2"



- EV13091-40  
40 mm / 1 1/2"
- EV13091-45  
45 mm / 1 3/4"
- EV13091-50  
50 mm / 2"

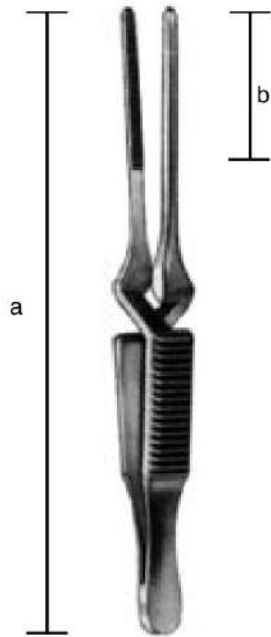


- GLOVER  
EV13098-06  
57 mm / 2 3/8"

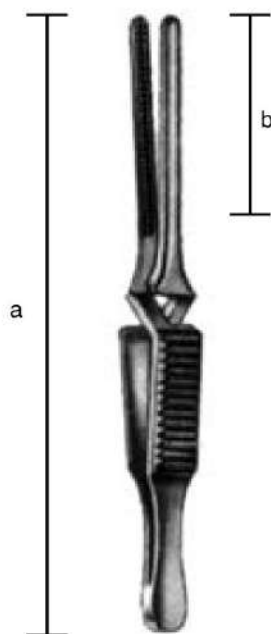
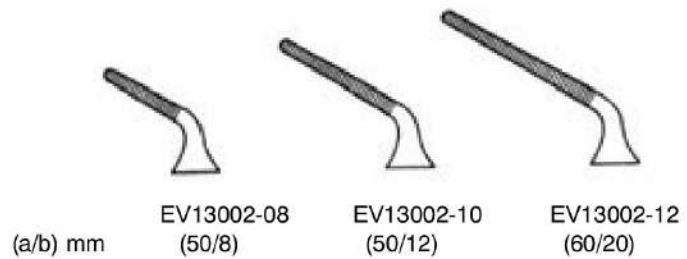
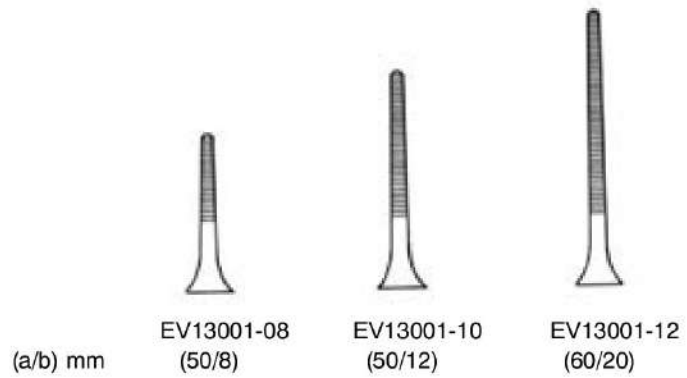


- DE BAKKEY  
EV13099-07  
73 mm / 2 3/4"

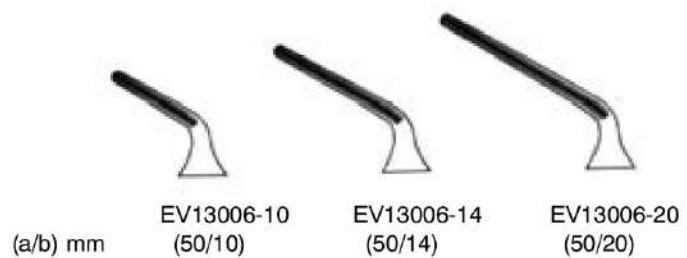
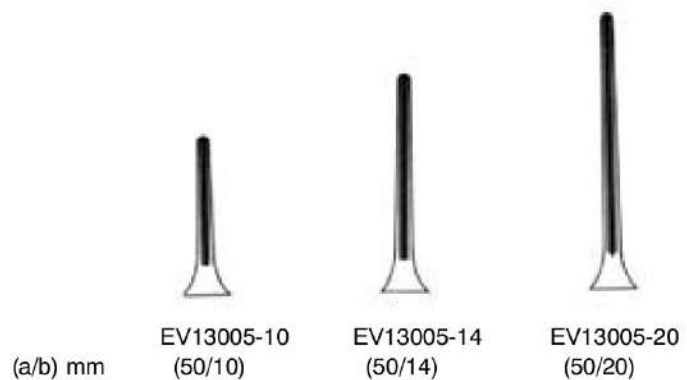
Mini-Bulldogklemmen  
Mini Bulldog Clamps  
Clamps Bulldog Mini  
Pinze Bulldog Mini



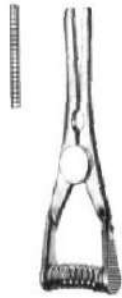
DIETRICH



DEBAKEY-DIETRICH

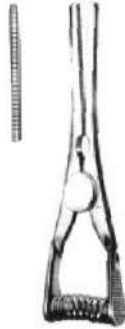


Titan-Atrauma-Bulldogklemmen  
 Titanium Atrauma Bulldog Clamps  
 Titan Clamp Bulldog  
 Titan Pinze Bulldog



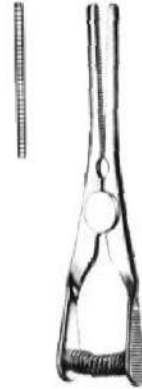
3 cm, 1.2"

Vene  
 Arterie **EV13010-30**  
**EV13011-30**



3,5 cm, 1.4"

**EV13010-35**  
**EV13011-35**



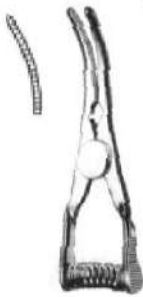
4 cm, 1 1/2"

**EV13010-40**  
**EV13011-40**



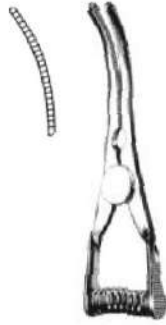
5 cm, 2"

**EV13010-50**  
**EV13011-50**



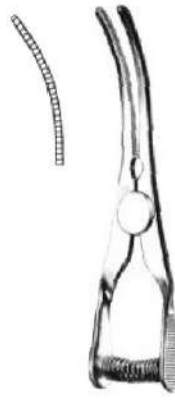
3 cm, 1.2"

Vena  
 Arteria **EV13012-30**  
**EV13013-30**



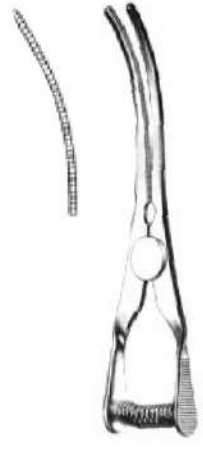
3,5 cm, 1.4"

**EV13012-35**  
**EV13013-35**



4 cm, 1 1/2"

**EV13012-40**  
**EV13013-40**



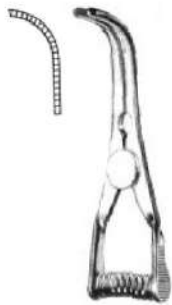
5 cm, 2"

**EV13012-50**  
**EV13013-50**



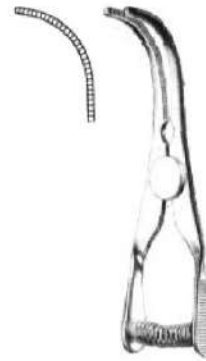
3 cm, 1.2"

Vene  
 Arterie **EV13014-30**  
**EV13015-30**



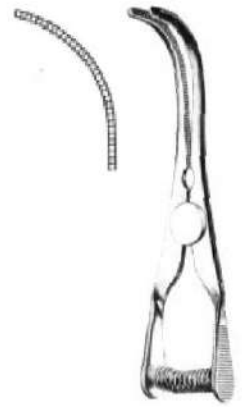
3,5 cm, 1.4"

**EV13014-35**  
**EV13015-35**



4 cm, 1 1/2"

**EV13014-40**  
**EV13015-40**



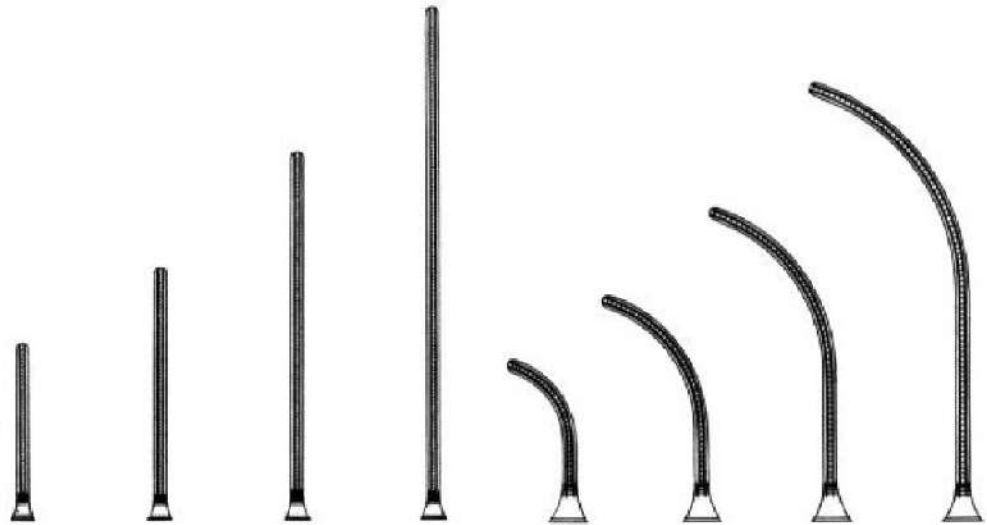
5 cm, 2"

**EV13014-50**  
**EV13015-50**

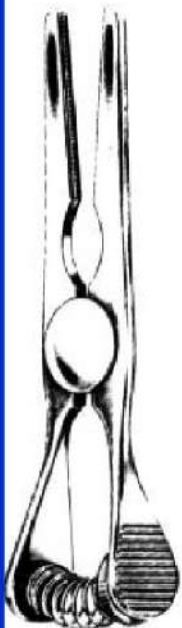
Atrauma-Bulldogklemmen  
 Atrauma Bulldog Clamps  
 Clamps Atrauma Bulldog  
 Pinze Atrauma Bulldog



DE BAKEY



|            |            |            |            |            |            |            |            |
|------------|------------|------------|------------|------------|------------|------------|------------|
| EV13092-07 | EV13092-08 | EV13092-10 | EV13092-12 | EV13093-07 | EV13093-08 | EV13093-10 | EV13093-12 |
| 7,5 cm     | 8,5 cm     | 10,5 cm    | 12 cm      | 7 cm       | 8 cm       | 10 cm      | 11,5 cm    |
|            | 3"         | 3.4"       | 4" 4 3/4"  | 2 3/4"     | 8 1/8"     | 4"         | 4 1/2"     |



GLOVER



|            |            |            |            |            |            |            |            |
|------------|------------|------------|------------|------------|------------|------------|------------|
| EV13096-06 | EV13096-07 | EV13096-09 | EV13096-11 | EV13097-06 | EV13097-07 | EV13097-09 | EV13097-11 |
| 6 cm       | 7 cm       | 9 cm       | 11 cm      | 5,5 cm     | 6,5 cm     | 8,5 cm     | 10,5 cm    |
| 2 1/4"     | 2 3/4"     | 3 1/2"     | 4 3/8"     | 2"         | 2 1/2"     | 3 1/4"     | 4"         |

Gefäßklemmen, Bulldogklemmen, Arterienklemmen  
 Hemostatic Forceps  
 Pinzas hemostáticas  
 Pinze serraфина, Pinze emostatiche



**DIEFFENBACH**  
 EV13102-04 3,5 cm, 1.4"  
 EV13102-05 5,5 cm, 2.2"



gerade  
 straight  
 recta  
 rette

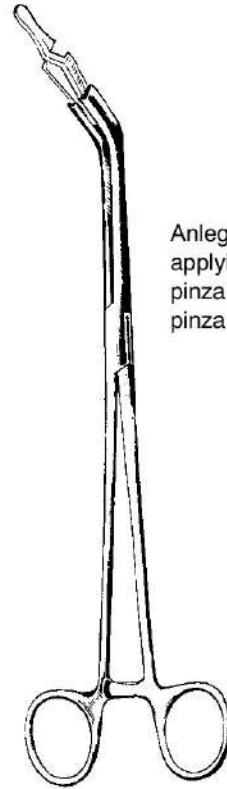
gebogen  
 curved  
 curva  
 curve



**DIEFFENBACH**  
 EV13103-04 3,5 cm, 1.4"  
 EV13103-05 5,5 cm, 2.2"

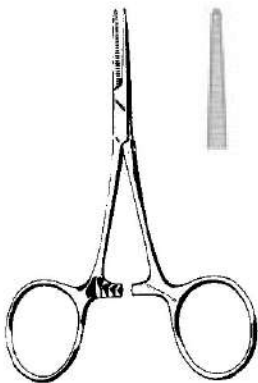
**JOHNS-HOPKINS**

- |                           |            |
|---------------------------|------------|
| EV13110-50 5,0 cm, 2"     | EV13111-50 |
| EV13110-55 5,5 cm, 2.2"   | EV13111-55 |
| EV13110-65 6,5 cm, 2.6"   | EV13111-65 |
| EV13110-70 7,0 cm, 2 3/4" | EV13111-70 |
| EV13110-75 7,5 cm, 3"     | EV13111-75 |
| EV13110-90 9,0 cm, 3 1/2" | EV13111-90 |

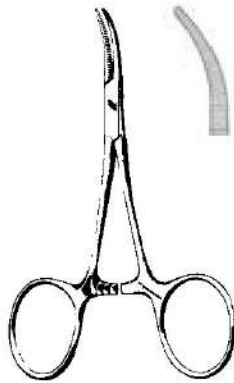


Anlagezange  
 applying forceps  
 pinza para poner  
 pinza applicatrice

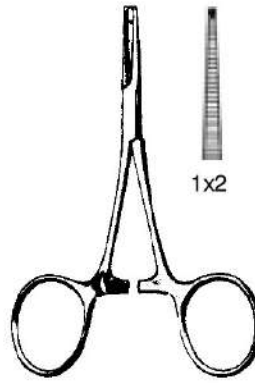
EV13115-00  
 23 cm, 9"



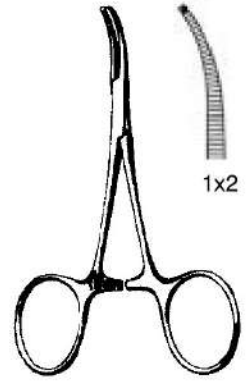
**HARTMANN**  
 EV13210-10  
 10 cm, 4"



**HARTMANN**  
 EV13211-10  
 10 cm, 4"



**HARTMANN**  
 EV13212-10  
 10 cm, 4"



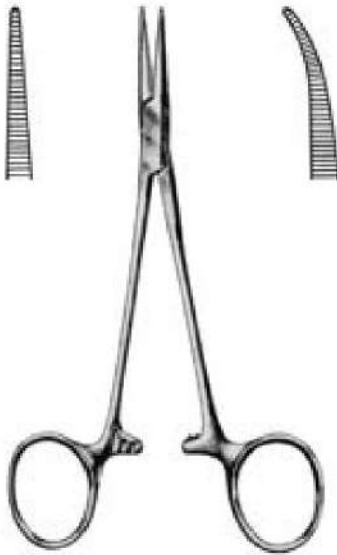
**HARTMANN**  
 EV13213-10  
 10 cm, 4"

**Micro-HARTMANN**  
 EV13214-10  
 10 cm, 4"

**Micro-HARTMANN**  
 EV13215-10  
 10 cm, 4"

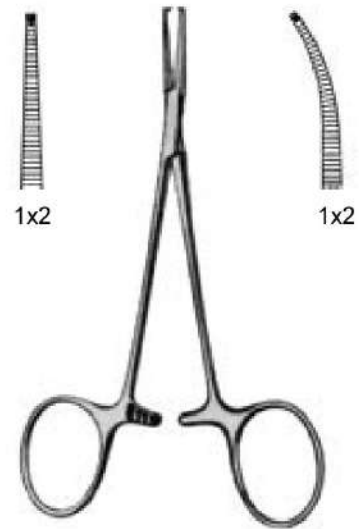
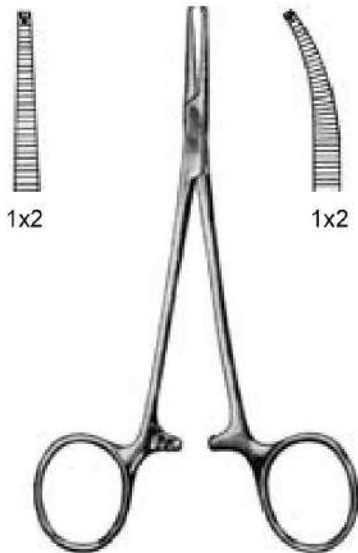


Arterienklemmen  
Hemostatic Forceps  
Pinzas hemostáticas  
Pinze emostatiche



TITAN — HALSTED-MOSQUITO — TITAN  
**EV13224-12** EV13220-12 12,5 cm, 5" EV13221-12 **EV13225-12**  
 EV13220-14 14,0 cm, 5 1/2" EV13221-14  
 EV13220-18 18,0 cm, 7" EV13221-18  
 EV13220-21 21,0 cm, 8 1/4" EV13221-21

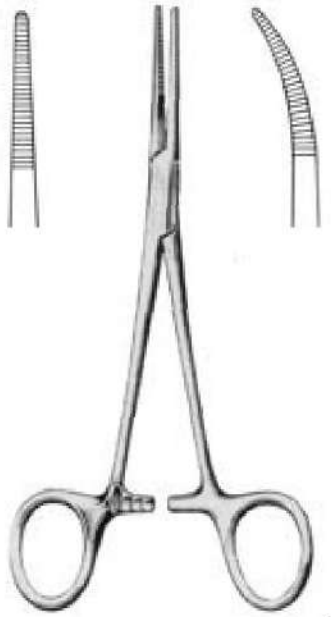
— HALSTED-MOSQUITO micro —  
 EV13222-12 12,5 cm, 5" EV13223-12  
 JACOBSON micro  
 EV13226-12 12,0 cm, 4 3/4" EV13227-12



— HALSTED-MOSQUITO —  
 EV13230-12 12,5 cm, 5" EV13231-12  
 EV13230-14 14,0 cm, 5 1/2" EV13231-14  
 EV13230-18 18,0 cm, 7" EV13231-18  
 EV13230-21 21,0 cm, 8 1/4" EV13231-21

— HALSTED-MOSQUITO micro —  
 EV13232-12 EV13233-12

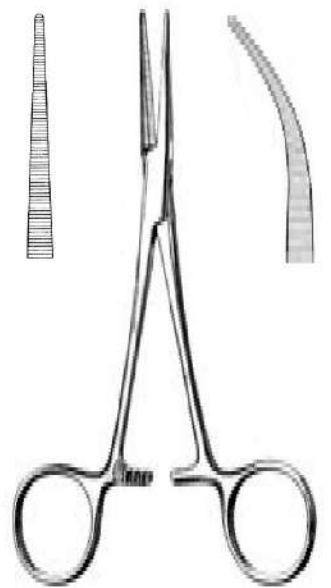
Arterienklemmen  
 Hemostatic Forceps  
 Pinzas hemostáticas  
 Pinze emostatiche



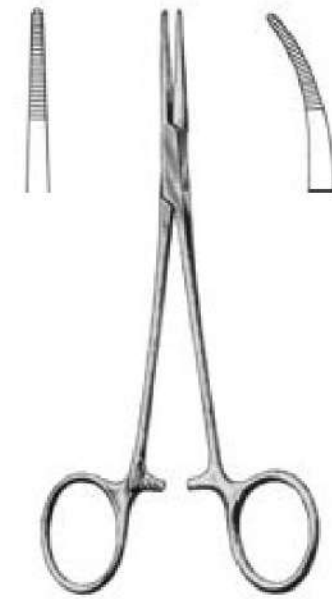
**KELLY**  
 EV13240-14 14 cm, 5 1/2" EV13241-14  
 EV13240-18 18 cm, 7" EV13241-18  
 EV13244-14 14 cm, 5 1/2" EV13245-14  
 TITAN TITAN



**KELLY-RANKIN**  
 EV13242-16 16 cm, 6 1/4" EV13243-16



**COLLER-CRILE**  
 EV13256-14 14 cm, 5 1/2" EV13257-14  
 EV13258-16 16 cm, 6 1/4" EV13259-16

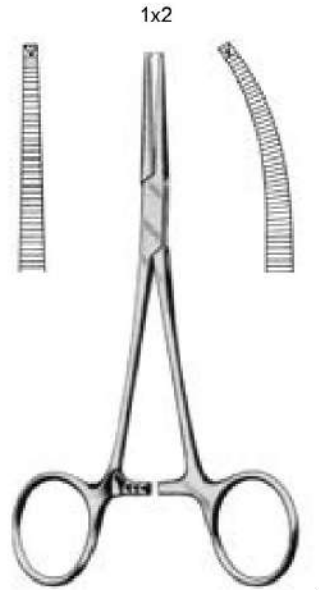


**PROVIDENCE-HOSPITAL**  
 EV13270-14 14 cm, 5 1/2" EV13271-14

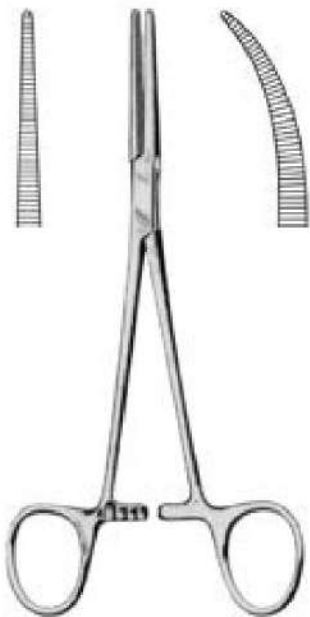
Arterienklemmen  
Hemostatic Forceps  
Pinzas hemostáticas  
Pinze emostatiche



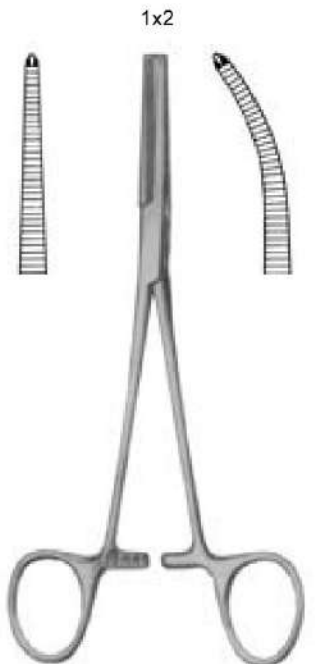
CRILE  
EV13250-14 14 cm, 5 1/2" EV13251-14  
EV13250-18 18 cm, 7" EV13251-18  
EV13254-14 14 cm, 5 1/2" EV13255-14  
TITAN TITAN



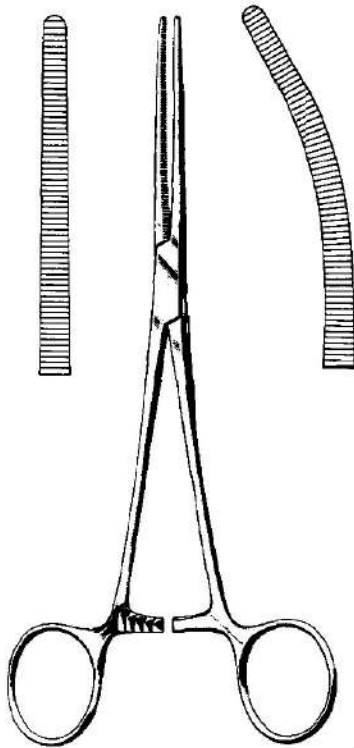
CRILE  
EV13260-14 14 cm, 5 1/2" EV13261-14



CRILE-RANKIN  
EV13262-16 16 cm, 6 1/4" EV13263-16

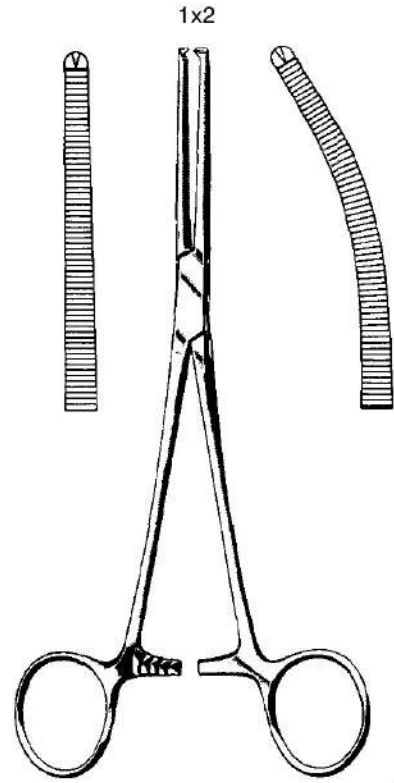


CRILE-RANKIN  
EV13264-16 16 cm, 6 1/4" EV13265-16



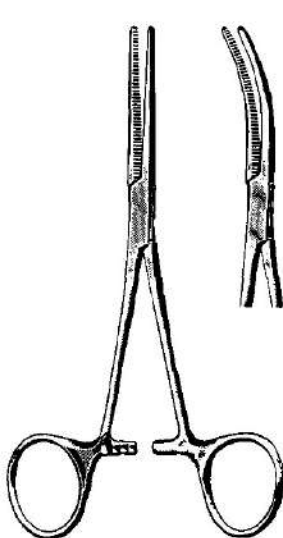
ROCHESTER-PEAN

|            |                |            |
|------------|----------------|------------|
| EV13310-13 | 13 cm, 5 1/8"  | EV13311-13 |
| EV13310-14 | 14 cm, 5 1/2"  | EV13311-14 |
| EV13310-16 | 16 cm, 6 1/4"  | EV13311-16 |
| EV13310-18 | 18 cm, 7"      | EV13311-18 |
| EV13310-20 | 20 cm, 8"      | EV13311-20 |
| EV13310-22 | 22 cm, 8 3/4"  | EV13311-22 |
| EV13310-24 | 24 cm, 9 1/2"  | EV13311-24 |
| EV13310-26 | 26 cm, 10 1/4" | EV13311-26 |
| EV13310-30 | 30 cm, 11 3/4" | EV13311-30 |



ROCHESTER-OSHSNER

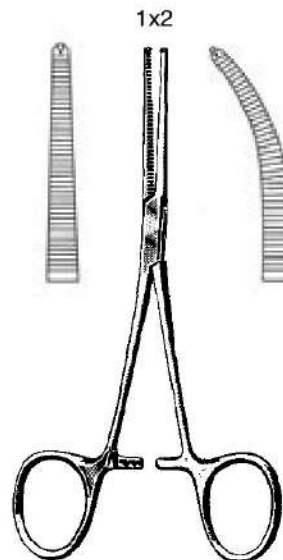
|            |                 |            |
|------------|-----------------|------------|
| EV13320-13 | EV13 cm, 5 1/8" | EV13321-13 |
| EV13320-14 | 14 cm, 5 1/2"   | EV13321-14 |
| EV13320-16 | 16 cm, 6 1/4"   | EV13321-16 |
| EV13320-18 | 18 cm, 7"       | EV13321-18 |
| EV13320-20 | 20 cm, 8"       | EV13321-20 |
| EV13320-22 | 22 cm, 8 3/4"   | EV13321-22 |
| EV13320-24 | 24 cm, 9 1/2"   | EV13321-24 |
| EV13320-26 | 26 cm, 10 1/4"  | EV13321-26 |
| EV13320-30 | 30 cm, 11 3/4"  | EV13321-30 |



Fein  
Delicate  
Delicada  
Fina

PEAN

|            |               |            |
|------------|---------------|------------|
| EV13312-14 | 14 cm, 5 1/2" | EV13313-14 |
| EV13312-16 | 16 cm, 6 1/4" | EV13313-16 |



Fein  
Delicate  
Delicada  
Fina

KOCHER

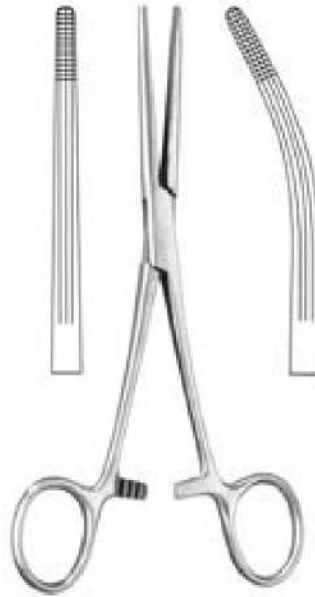
|            |               |            |
|------------|---------------|------------|
| EV13322-14 | 14 cm, 5 1/2" | EV13323-14 |
| EV13322-16 | 16 cm, 6 1/4" | EV13323-16 |

Arterienklemmen  
Hemostatic Forceps  
Pinzas hemostáticas  
Pinze emostatiche



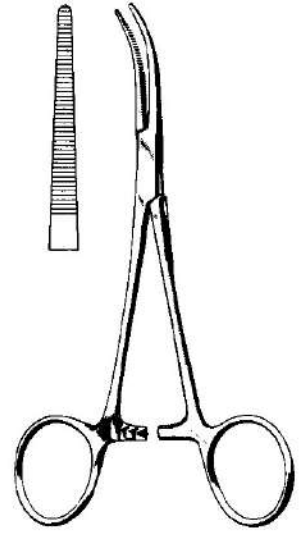
SPENCER-WELLS

- |            |           |            |
|------------|-----------|------------|
| EV13330-13 | 13 cm, 5" | EV13331-13 |
| EV13330-15 | 15 cm, 6" | EV13331-15 |
| EV13330-18 | 18 cm, 7" | EV13331-18 |
| EV13330-20 | 20 cm, 8" | EV13331-20 |



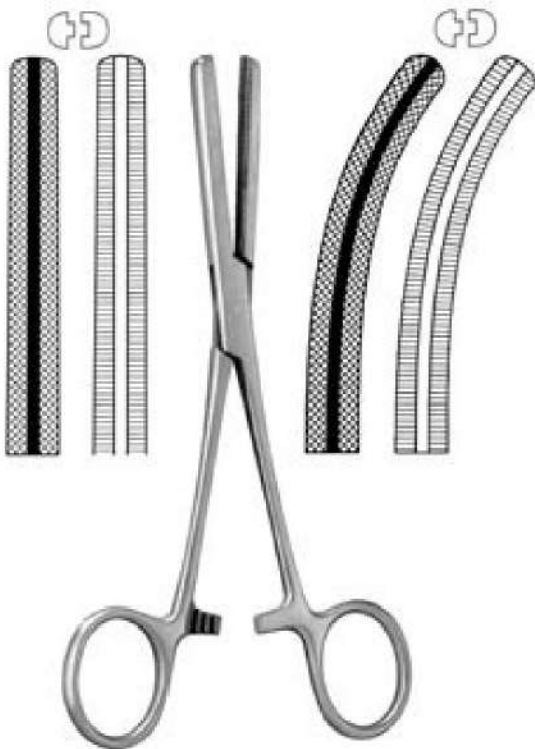
ROCHESTER-CARMALT

- |            |               |            |
|------------|---------------|------------|
| EV13340-16 | 16 cm, 6 1/4" | EV13341-16 |
| EV13340-20 | 20 cm, 8"     | EV13341-20 |



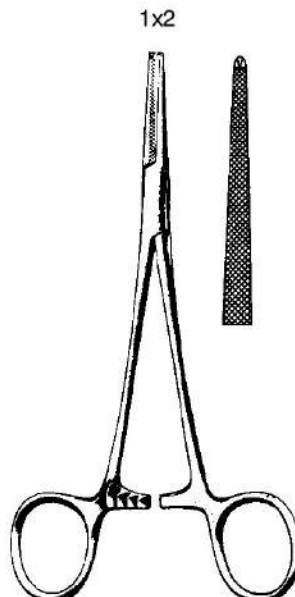
DANDY

- |            |               |
|------------|---------------|
| EV13345-12 | 12 cm, 4 3/4" |
| EV13345-14 | 14 cm, 5 1/2" |



FERGUSSON

- |            |               |            |
|------------|---------------|------------|
| EV13350-16 | 16 cm, 6 1/4" | EV13351-16 |
| EV13350-20 | 20 cm, 8"     | EV13351-20 |



LOVELACE

- |            |             |
|------------|-------------|
| EV13356-15 | 15,5 cm, 6" |
|------------|-------------|



PENNINGTON

- |            |             |
|------------|-------------|
| EV13358-15 | 15,5 cm, 6" |
| EV13358-20 | 20,0 cm, 8" |

Fasszangen  
Grasping Forceps  
Pinza para agarrar órganos y tejidos  
Pinze da presa

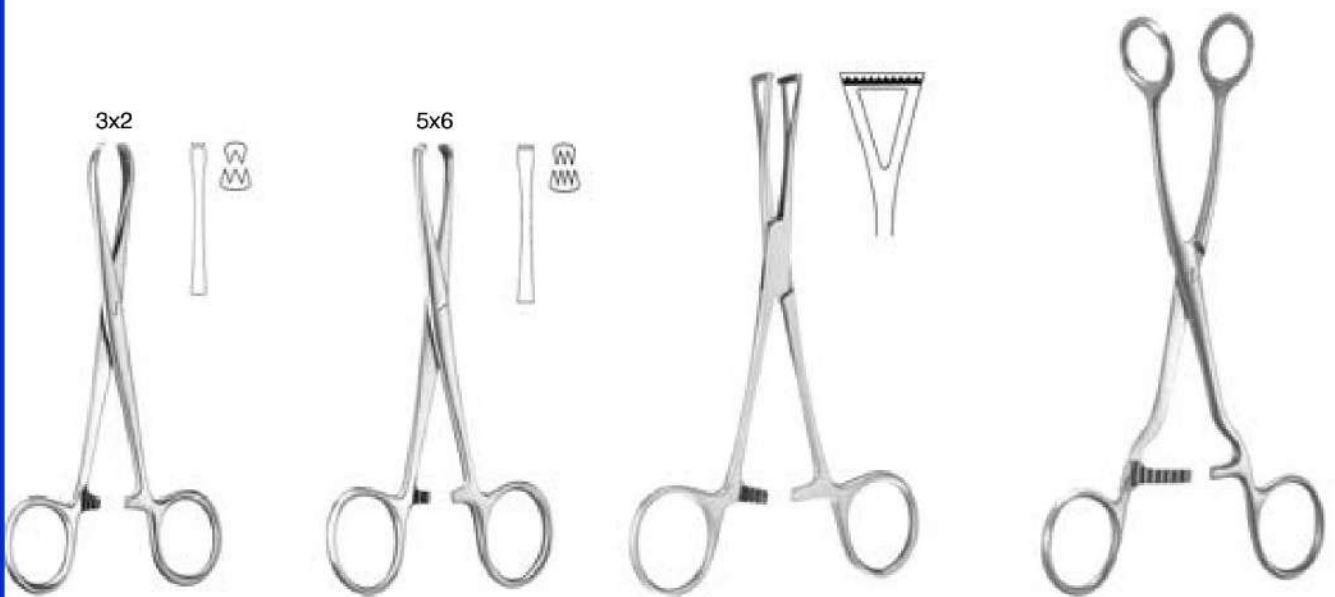


**PRATT**  
EV13360-15 15 cm, 6"

**MARTEL**  
EV13364-14 14 cm, 5 1/2"

**WILLET MARTEL**  
EV13366-19 19 cm, 7 1/2"

**PEAN**  
EV13368-14 14 cm, 5 1/2"  
EV13368-16 16 cm, 6 1/4"



**CHAPUT**  
EV13370-13  
13 cm, 5 1/8"

**TUFFIER**  
EV13372-13  
13 cm, 5 1/8"

**COLLIN**  
EV13374-14  
14 cm, 5 1/2"

**COLLIN**  
EV13376-16  
16 cm, 6 1/4"

Organ- und Gewebefasszange, Arterienklemmen  
 Organ- and Tissue Grasping Forceps, Hemostatic Forceps  
 Pinza para agarrar órganos y tejidos, Pinzas hemostáticas  
 Pinza per tessuti e organi, Pinze emostatiche



ELGEN Atrauma  
 EV13377-25 -  
 EV13377-26



EV13377-25  
 25 cm, 10"



EV13377-26  
 26 cm, 10 1/4"

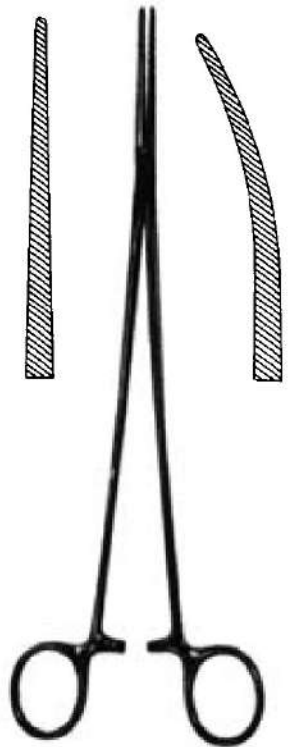


— LERICHE —  
 EV13380-15 15 cm, 6" EV13381-15



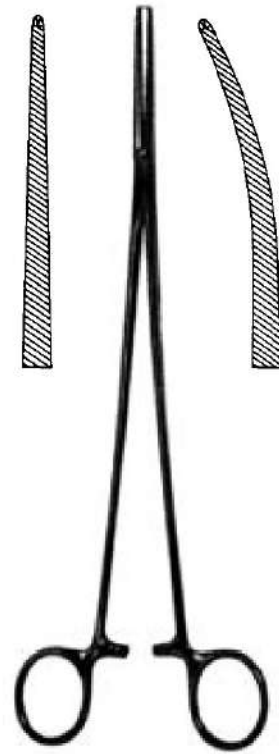
— LERICHE —  
 EV13382-15 15 cm, 6" EV13383-15

Arterienklemmen  
Hemostatic Forceps  
Pinzas hemostáticas  
Pinze emostatiche

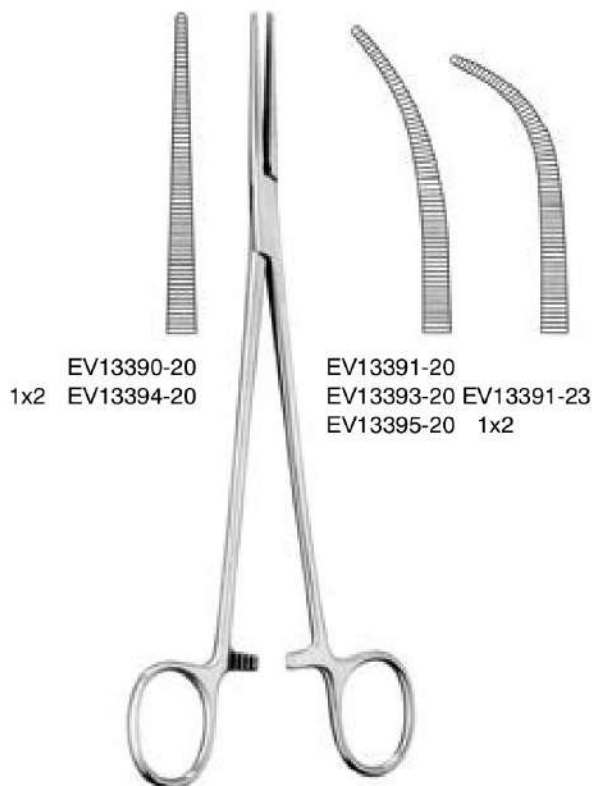


**BENGOLEA**  
EV13384-20 20 cm, 8" EV13385-20  
EV13384-26 26 cm, 10 1/4" EV13385-26

1x2



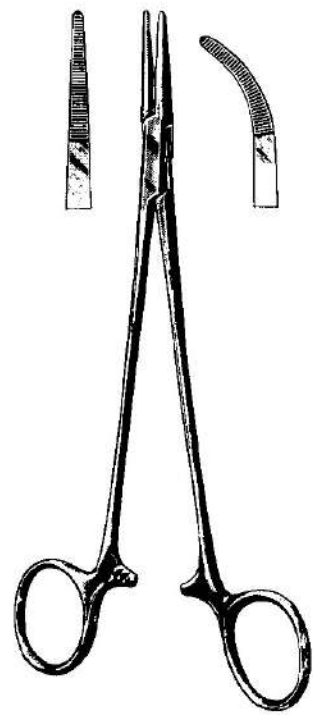
**BENGOLEA**  
EV13386-20 20 cm, 8" EV13387-20  
EV13386-26 26 cm, 10 1/4" EV13387-26



EV13390-20  
1x2 EV13394-20

EV13391-20  
EV13393-20 EV13391-23  
EV13395-20 1x2

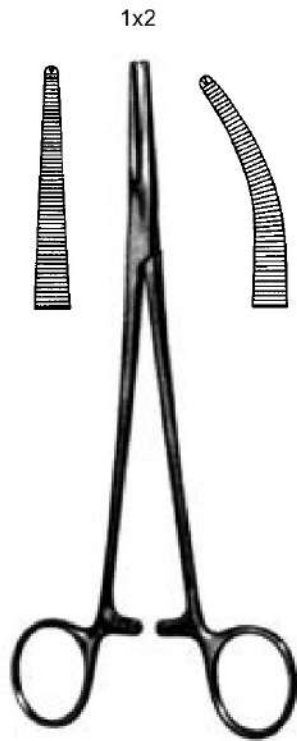
**HEISS**  
20 cm, 8"



**ADSON**  
EV13410-18 18,5 cm, 7 1/4" EV13411-18



Arterienklemmen  
Hemostatic Forceps  
Pinzas hemostáticas  
Pinze emostatiche



ADSON  
EV13412-18 18,5 cm, 7 1/4" EV13413-18



FUCHSIG  
EV13414-20 19 cm, 7 1/2"



ADSON BABY  
EV13415-14 14,0 cm, 5 1/2"  
EV13415-18 18,5 cm, 7 1/4"

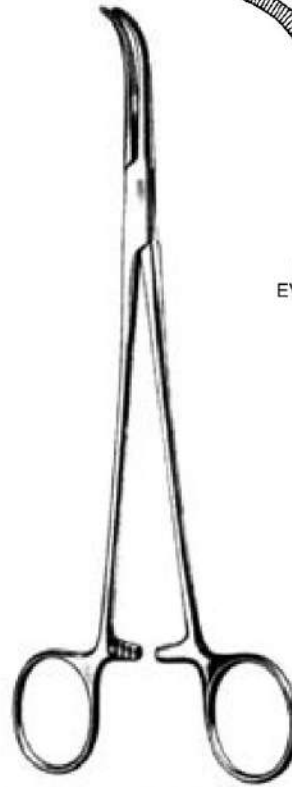


NISSEN  
EV13416-18 18,5 cm, 7 1/4"

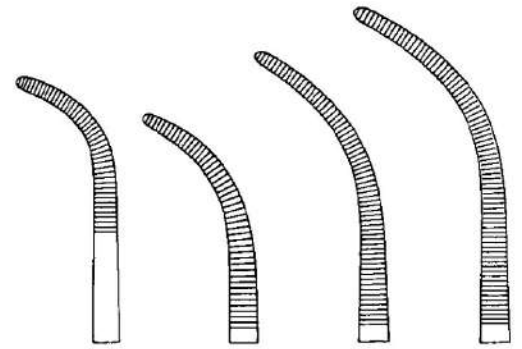
Arterienklemmen  
 Hemostatic Forceps  
 Pinzas hemostáticas  
 Pinze emostatiche



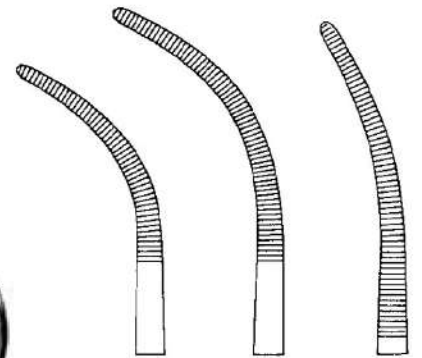
OVERHOLT-BABY  
 EV13420-14  
 14 cm, 5 1/2"



OVERHOLT-GEISSENDOERFER  
 21 cm, 8 1/4"



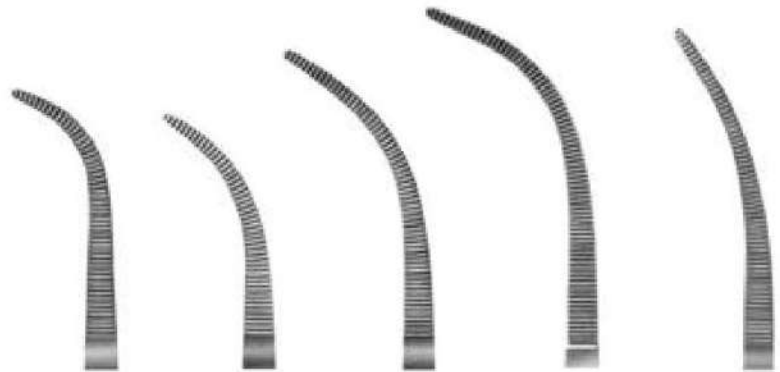
|                      |                                |                                |                                |
|----------------------|--------------------------------|--------------------------------|--------------------------------|
| Fig. 1<br>EV13421-01 | Fig. 2<br>EV13421-02           | Fig. 3<br>EV13421-03           | Fig. 4<br>EV13421-04           |
|                      | EV13425-02<br>26 cm<br>10 1/2" | EV13425-03<br>27 cm<br>10 1/2" | EV13425-04<br>27,5 cm<br>10.8" |



|                                |                            |                      |
|--------------------------------|----------------------------|----------------------|
| Fig. 5<br>EV13421-05           | Fig. 6<br>EV13421-06       | Fig. 7<br>EV13421-07 |
| EV13425-05<br>27 cm<br>10 1/2" | EV13425-06<br>28 cm<br>11" |                      |

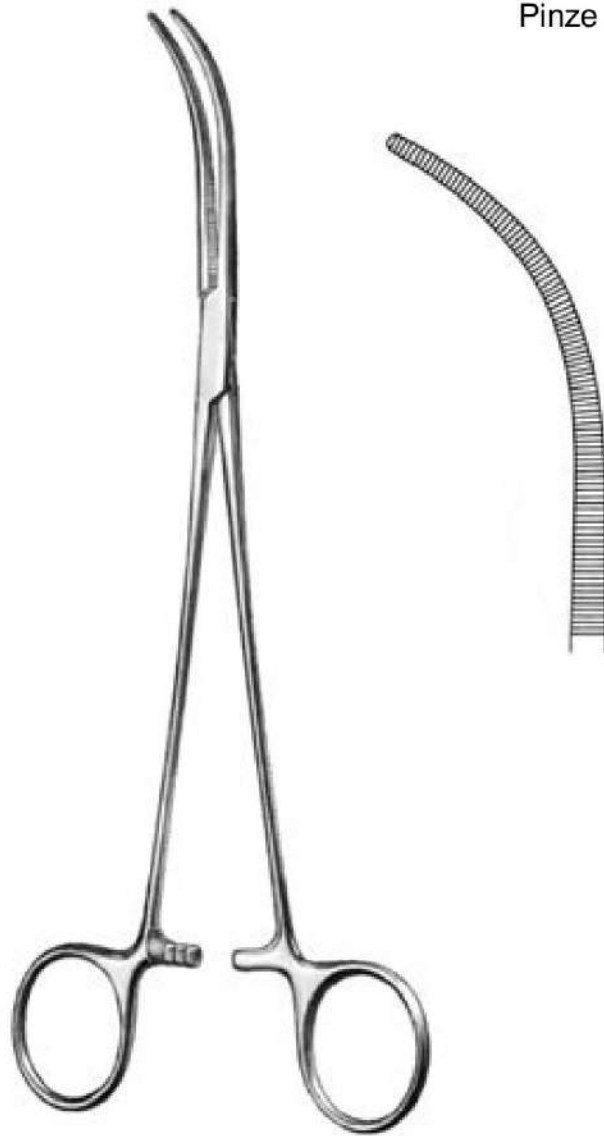


OVERHOLT



|   |   |   |                                     |   |
|---|---|---|-------------------------------------|---|
| EV13422-00<br>21,5 cm<br>8 1/2"<br>Fig. 0 | EV13422-01<br>21 cm<br>8 1/4"<br>Fig. 1 | EV13422-02<br>22 cm<br>8 3/4"<br>Fig. 2 | EV13422-03<br>23 cm<br>9"<br>Fig. 3 | EV13422-06<br>22,5 cm<br>8.9"<br>Fig. 6 |
|---|---|---|-------------------------------------|---|

Arterienklemmen  
 Hemostatic Forceps  
 Pinzas hemostáticas  
 Pinze emostatiche



OVERHOLT-MIXTER  
 EV13428-21  
 21,5 cm, 8 1/2"



GEMINI



EV13431-13  
 13 cm  
 5 1/8"



EV13431-16  
 16 cm  
 6 1/4"



EV13431-18  
 18 cm  
 7"



EV13431-20  
 20 cm  
 8"



EV13431-23  
 23 cm  
 9"

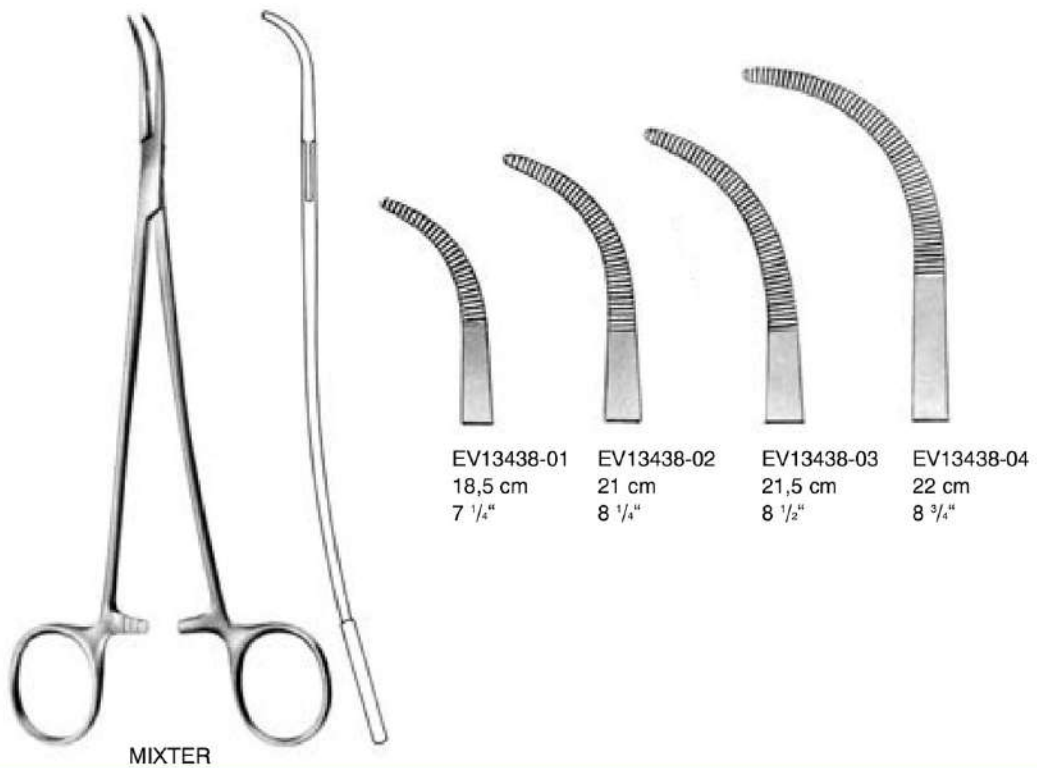


EV13431-25  
 25 cm  
 10"

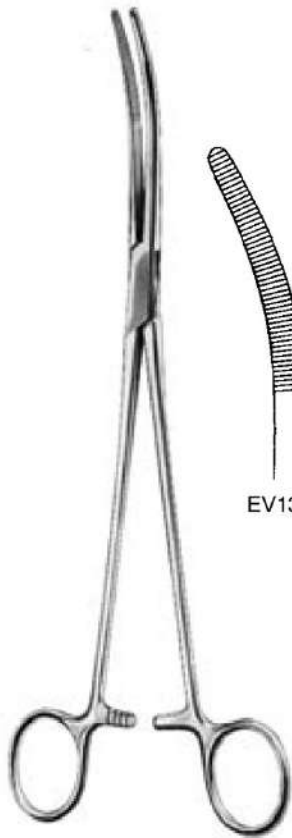


EV13431-28  
 28 cm  
 11"

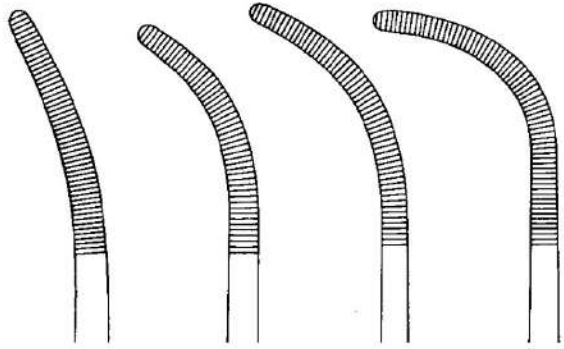
Arterienklemmen  
Hemostatic Forceps  
Pinzas hemostáticas  
Pinze emostatiche



Arterienklemmen  
Hemostatic Forceps  
Pinzas hemostáticas  
Pinze emostatiche



RUMEL  
23 cm, 9"



EV13441-01 EV13441-02 EV13441-03 EV13441-04



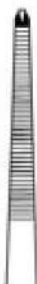
WIKSTROEM  
EV13447-20  
20,5 cm, 8"



EV13442-21 21 cm, 8 1/4"  
EV13442-26 26 cm, 10 1/4"

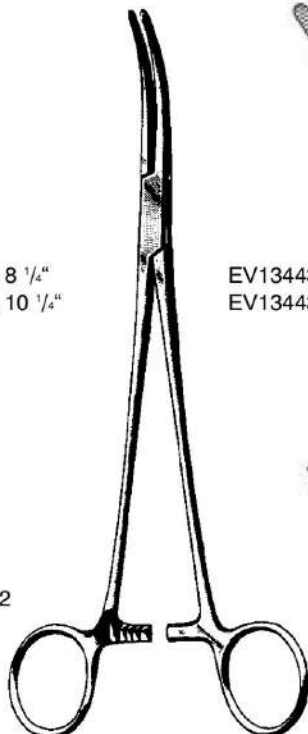


EV13443-21 21 cm, 8 1/4"  
EV13443-26 26 cm, 10 1/4"



1x2

EV13444-21 21 cm, 8 1/4"  
EV13444-26 26 cm, 10 1/4"

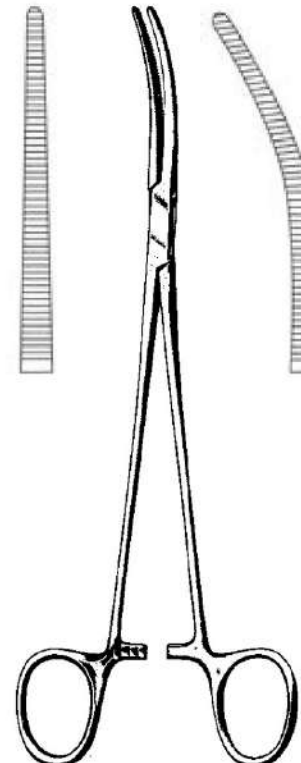


TOENNIS



1x2

EV13445-21 21 cm, 8 1/4"  
EV13445-26 26 cm, 10 1/4"



ROBERTS  
EV13448-22 22 cm, 8 3/4" EV13449-22

Arterienklemmen  
 Hemostatic Forceps  
 Pinzas hemostáticas  
 Pinze emostatiche



CRAFOORD  
 EV13453-18 18 cm, 7"  
 EV13453-24 24 cm, 9 1/2"



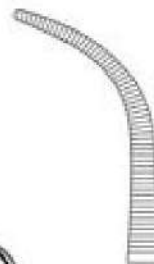
SAROT  
 EV13450-24 24 cm, 9 1/2" EV13451-24



EV13455-01

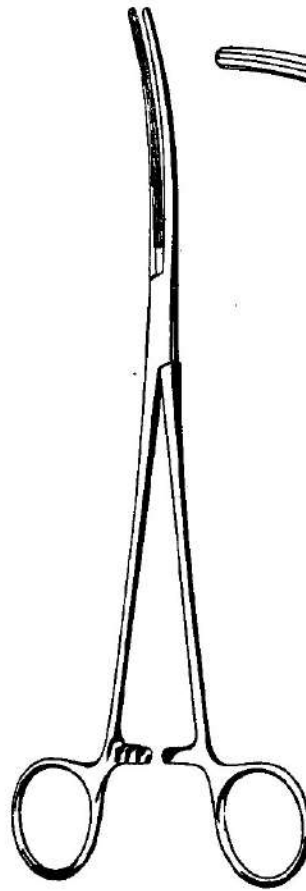


ZENKER  
 29,5 cm, 11 1/2"

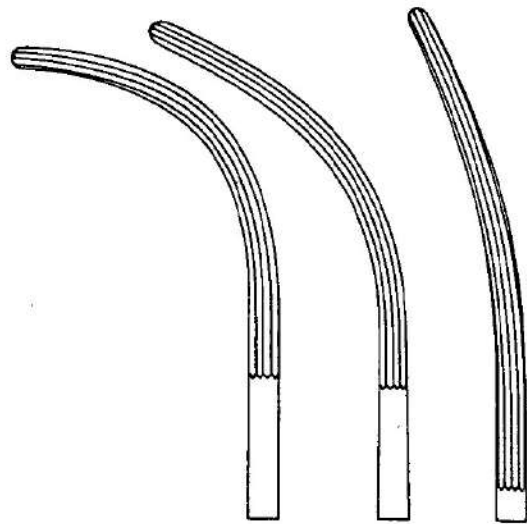


EV13455-02

Arterienklemmen  
 Hemostatic Forceps  
 Pinzas hemostáticas  
 Pinze emostatiche



CRAFOORD-SELLORS  
 24 cm, 9 1/2"



EV13456-01 EV13456-02 EV13456-03

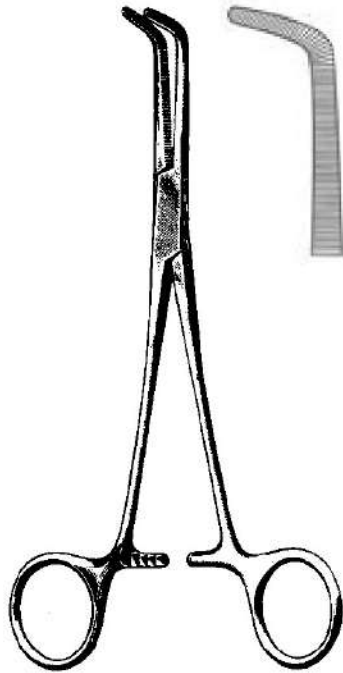


LAWRENCE  
 EV13457-28 28 cm, 11"



MEEKER  
 EV13459-18 18 cm, 7"  
 EV13459-28 28 cm, 11"

Arterienklemmen  
 Hemostatic Forceps  
 Pinzas hemostáticas  
 Pinze emostatiche



MIXTER  
 EV13471-14 14 cm, 5 1/2"  
 EV13471-16 16 cm, 6 1/4"  
 EV13471-18 18 cm, 7"  
 EV13471-23 23 cm, 9"



MIXTER  
 EV13473-22  
 22 cm, 8 3/4"



KANTROWITZ  
 EV13474-19 19 cm, 7 1/2"  
 EV13474-24 24 cm, 9 1/2"  
 EV13474-26 26 cm, 10 1/4"



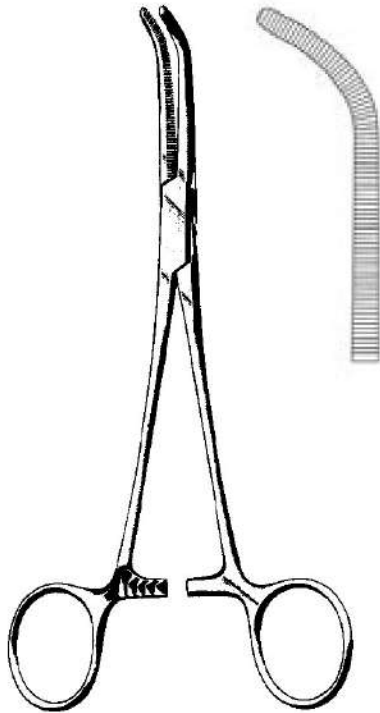
MIXTER BABY  
 EV13475-14  
 14 cm, 5 1/2"



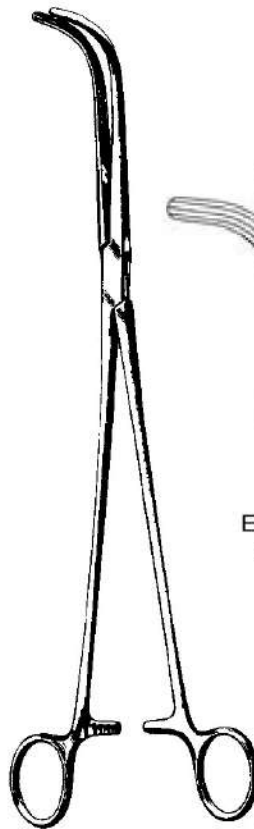
MIXTER BABY  
 EV13475-18  
 18 cm, 7"



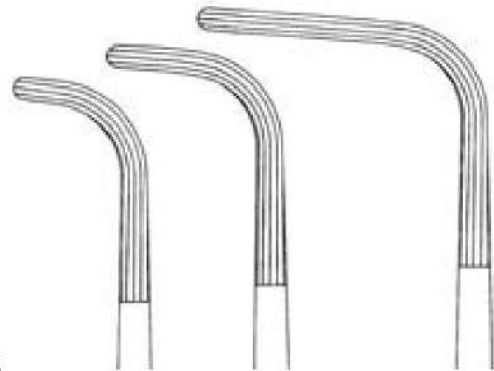
Arterienklemmen  
Hemostatic Forceps  
Pinzas hemostáticas  
Pinze emostatiche



MIXTER-O'SHAUGHNESSY  
EV13477-15 15,5 cm, 6"  
EV13477-19 19,0 cm, 7 1/2"



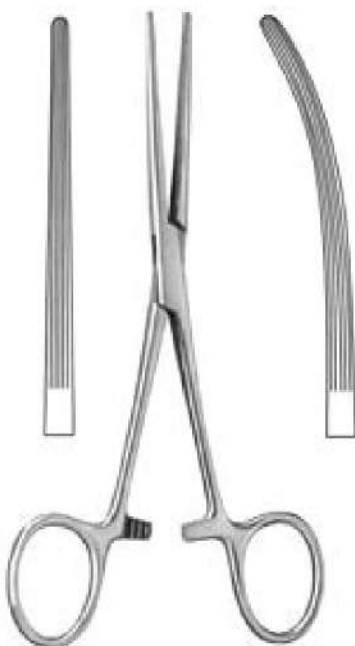
MIXTER



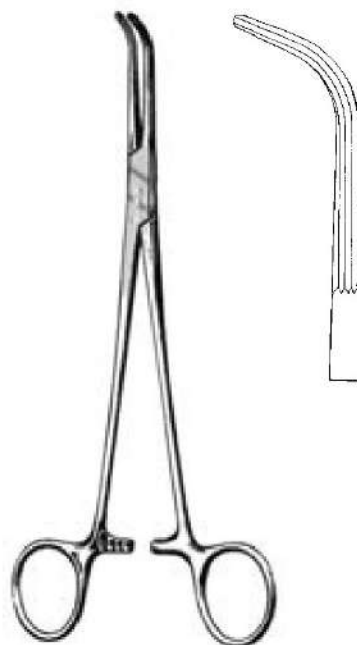
EV13479-22  
22 cm  
8 3/4"

EV13479-25  
25 cm  
10"

EV13479-28  
28 cm  
11"



BAINBRIDGE  
EV13480-15 15,0 cm, 6" EV13481-15  
EV13480-18 18,5 cm, 7 1/4" EV13481-18



LAHEY  
EV13491-19 19 cm, 7 1/2"

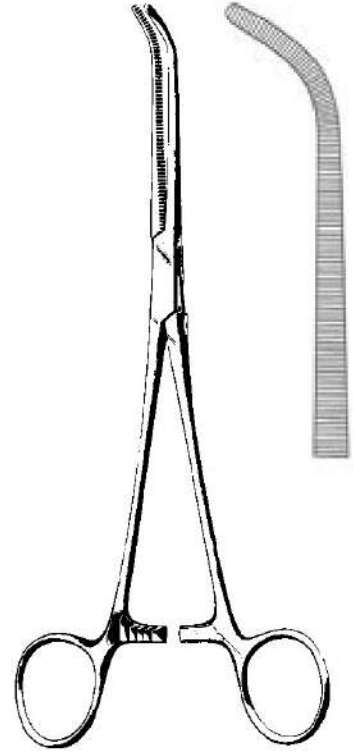
Arterienklemmen  
Hemostatic Forceps  
Pinzas hemostáticas  
Pinze emostatiche



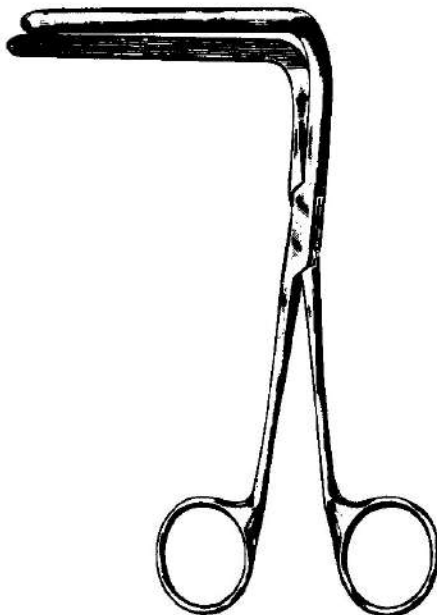
LAHEY  
EV13493-23 23 cm, 9"



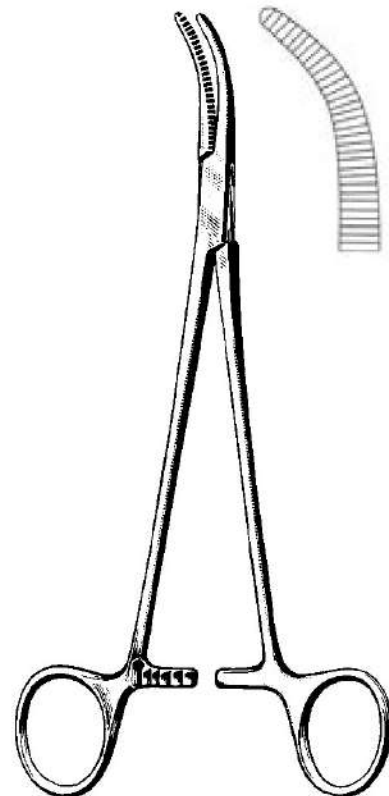
LOWER  
EV13495-18 18 cm, 7"



JOHNS-HOPKINS  
EV13497-20 20 cm, 8"

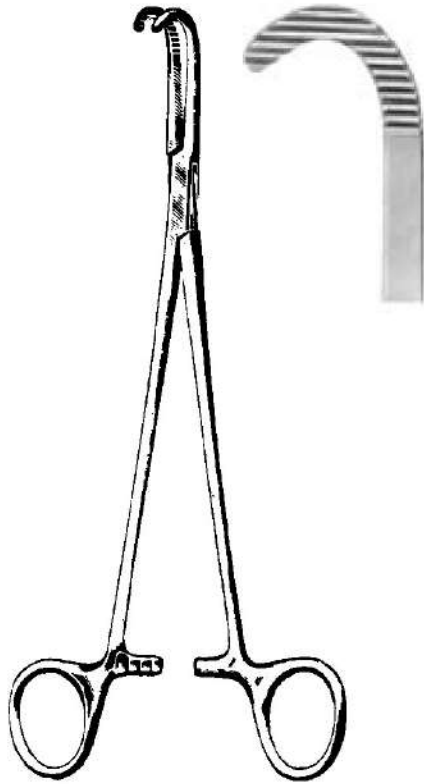


MIXTER  
EV13499-16  
16,5 cm, 6 1/2"

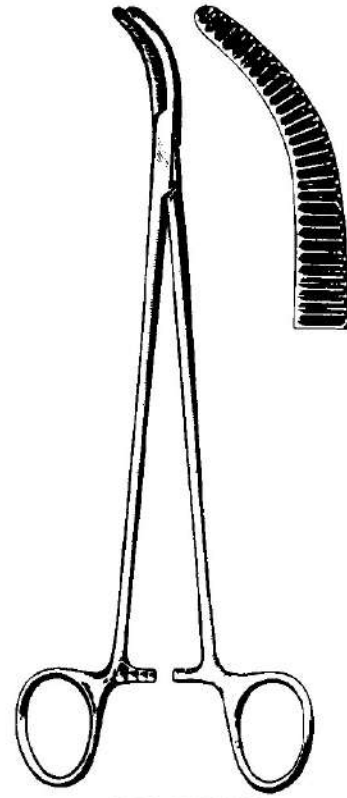


MOYNIHAN  
EV13501-23  
23 cm, 9"

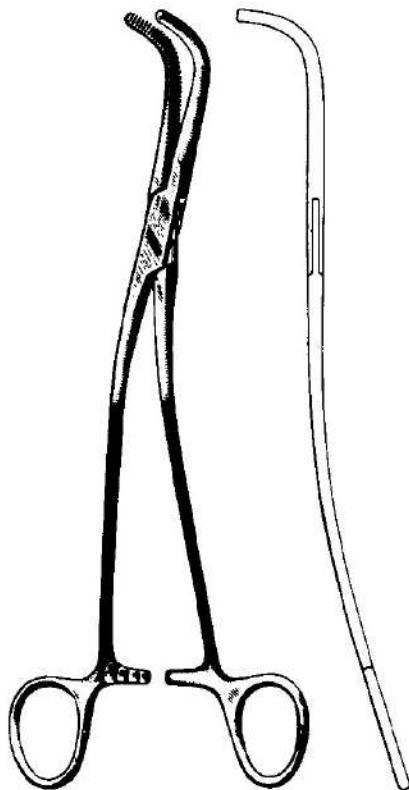
Arterienklemmen  
 Hemostatic Forceps  
 Pinzas hemostáticas  
 Pinze emostatiche



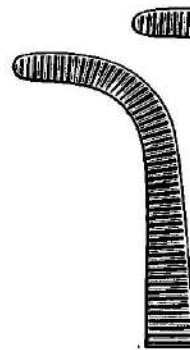
DESJARDINS  
 EV13503-21 21 cm, 8 1/4"



DESJARDINS  
 EV13505-21 21 cm, 8 1/4"



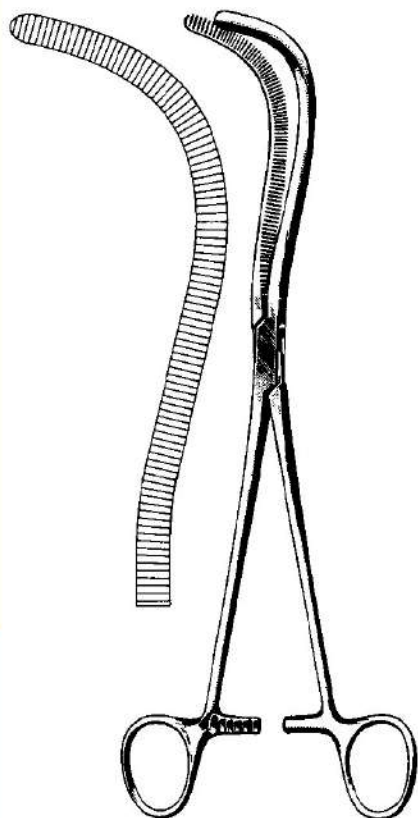
GRAY



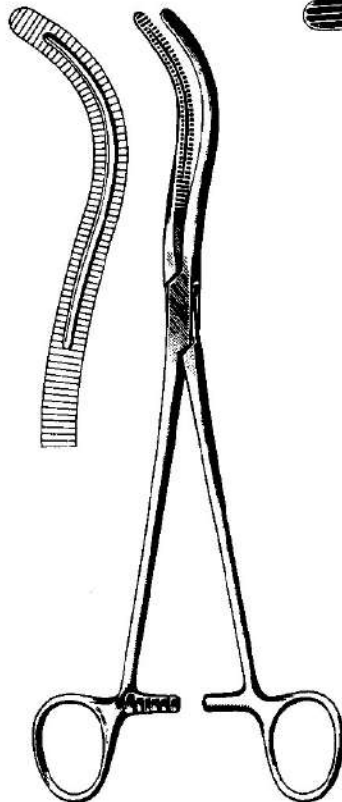
EV13507-22  
 22 cm  
 8 3/4"



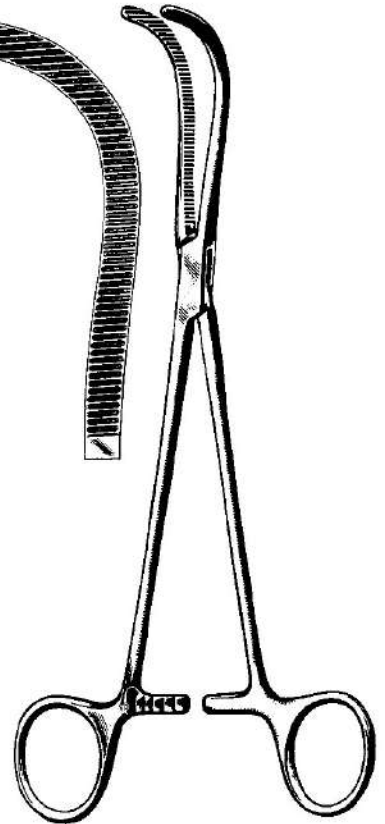
EV13507-23  
 23 cm  
 9"



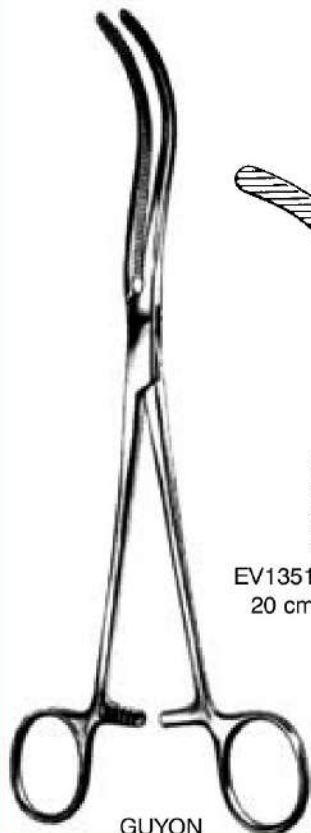
MAYO-GUYON  
EV13513-23  
23 cm, 9"



STILLE  
EV13515-23  
23 cm, 9"



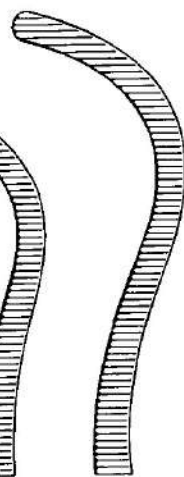
GUYON  
EV13517-23  
23 cm, 9"



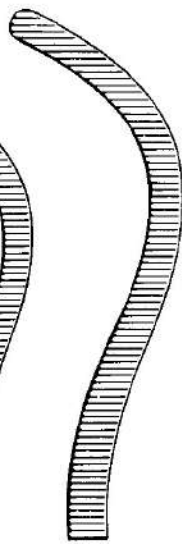
GUYON



EV13519-20  
20 cm  
8"



EV13519-22  
22 cm  
8 3/4"



EV13519-24  
24 cm  
9 1/2"



GUYON

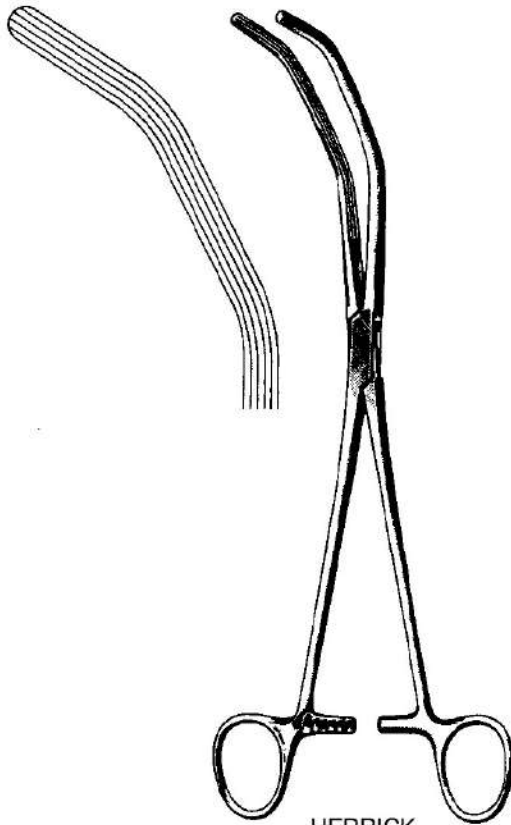


EV13520-24  
24 cm  
9 1/2"

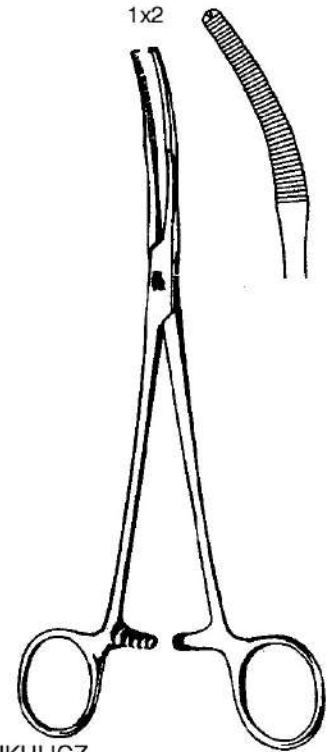
EV13520-23  
23 cm 9"

ATRAUMA

Hysterektomieklemmen  
Hysterectomy Forceps  
Pinzas para histerectomía  
Pinze per isterectomia

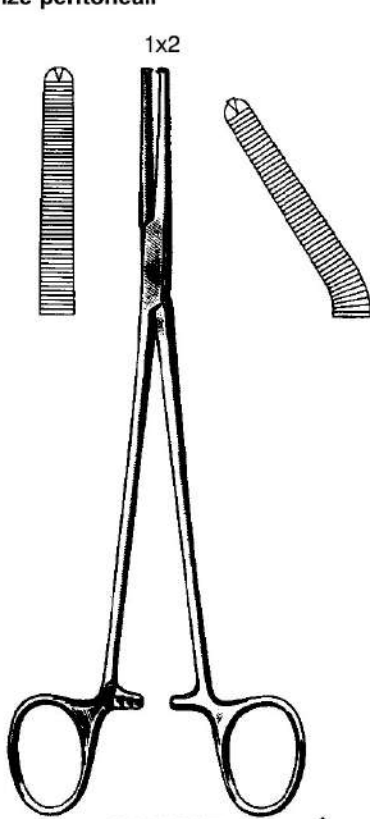


HERRICK  
EV13523-23  
23 cm, 9"



MIKULICZ  
EV13551-14 14 cm, 5 1/2" BABY  
EV13551-18 18 cm, 7"  
EV13551-20 20 cm, 8"

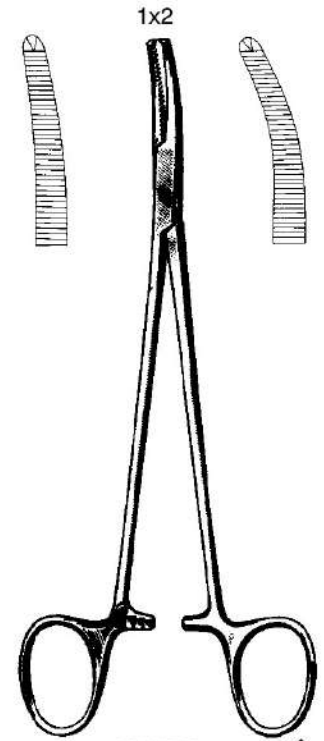
Peritoneum-Klemme  
Peritoneum Forceps  
Pinzas para peritoneo  
Pinze peritoneali



PHANEUF  
EV13554-21 21 cm, 8 1/4" EV13555-21



MIKULICZ  
EV13556-24 24 cm, 9 1/2"



FAURE  
EV13561-20 20 cm, 8" EV13563-20

Hysterektomieklemmen  
Hysterectomy Forceps  
Pinzas para histerectomía  
Pinze per isterectomia



MAINGOT  
EV13564-20 20 cm, 8"

Hysterektomieklemmen  
Hysterectomy Forceps  
Pinzas para histerectomía  
Pinze per isterectomia



MAINGOT

EV13565-20  
20,5 cm, 8"

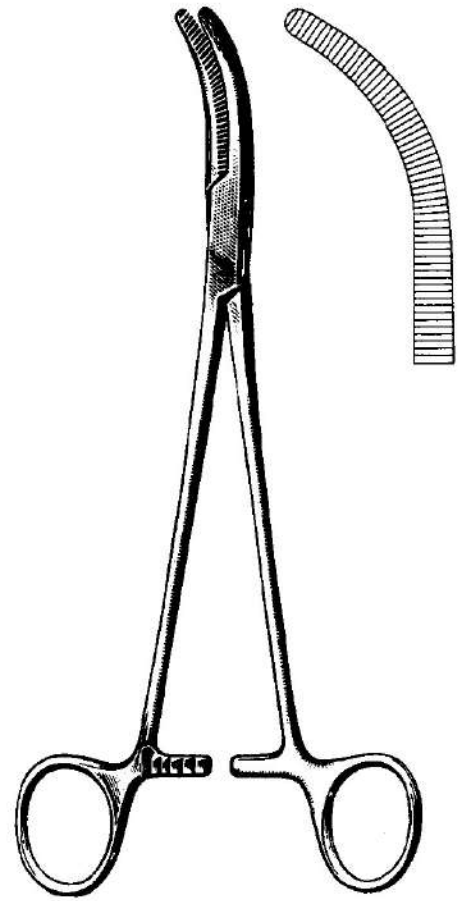


EV13565-25  
25 cm, 10"

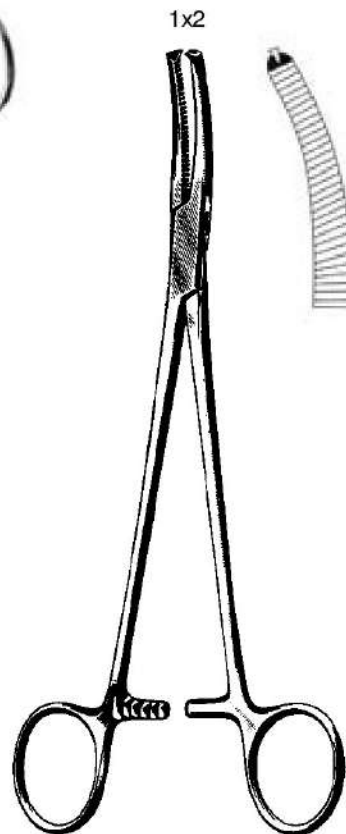
Hysterektomieklemmen  
Hysterectomy Forceps  
Pinzas para histerectomía  
Pinze per isterectomia



WERTHEIM  
EV13570-23  
23,5 cm, 9 1/4"



WERTHEIM  
EV13571-25  
25 cm, 10"



WERTHEIM  
EV13573-22 22 cm, 8 3/4"



Hysterektomieklemmen  
Hysterectomy Forceps  
Pinzas para histerectomía  
Pinze per isterectomia



SEGOND-LANDAU  
EV13574-24  
24 cm, 9 1/2"



SEGOND  
EV13575-24  
24 cm, 9 1/2"



WERTHEIM-CULLEN  
EV13579-21 21,5 cm, 8 1/2"

Hysterektomieklemmen  
 Hysterectomy Forceps  
 Pinzas para histerectomía  
 Pinze per isterectomia



EV13580-80  
 80 mm, 3" Maul/  
 Morso/Boca



EV13580-60  
 60 mm, 2 1/4"  
 Maul/Morso/Boca



23 cm, 9"



EV13591-20  
 EV13591-23

EV13593-20  
 EV13593-23

HEANEY  
 20 cm, 8"

1x2



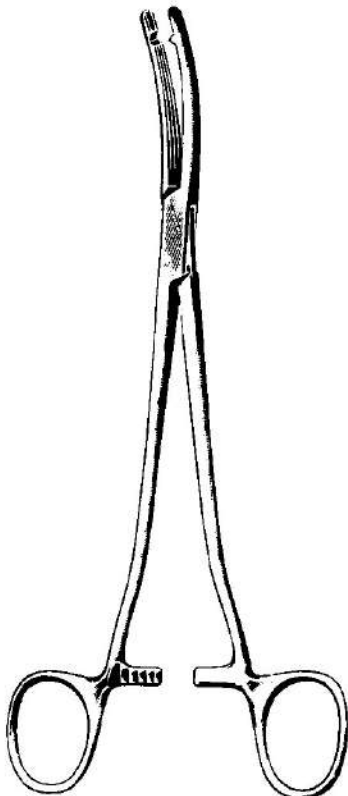
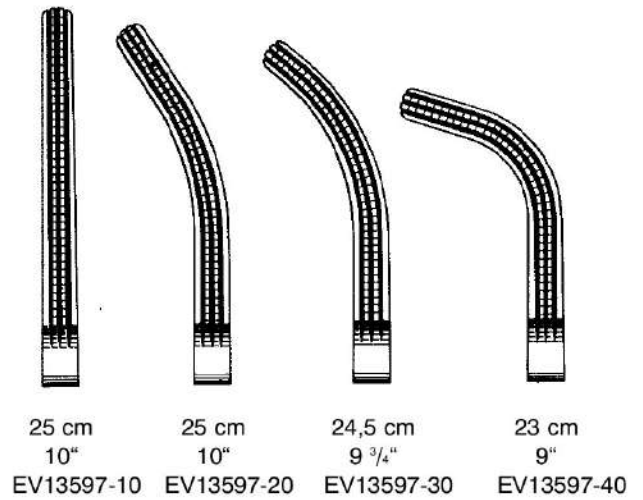
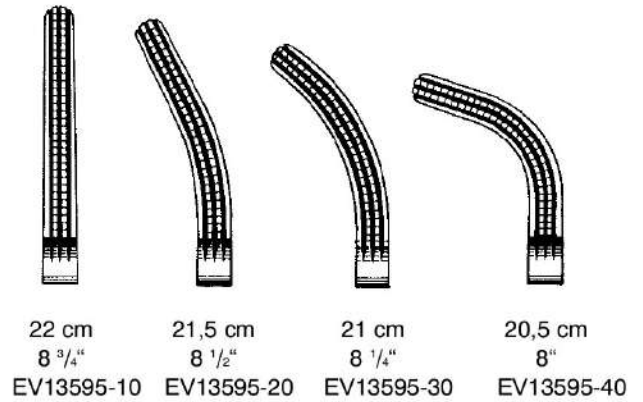
EV13598-24 24 cm, 9 1/2" EV13599-24

Hysterektomieklemmen  
 Hysterectomy Forceps  
 Pinzas para histerectomía  
 Pinze per isterectomia

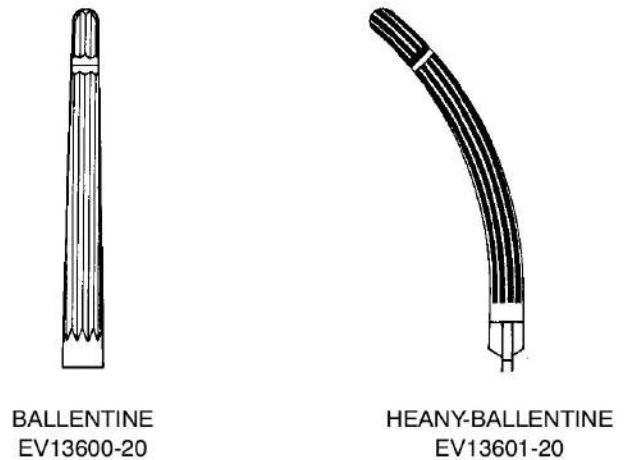


ATRAUMA

ROGERS  
 EV13595-10 - EV13597-40



HEANY-BALLENTINE  
 EV13600-20 - EV13601-20  
 20 cm, 8"



Hysterektomieklemmen  
Hysterectomy Forceps  
Pinzas para histerectomía  
Pinze per isterectomia



WERTHEIM  
EV13605-26  
25,5 cm, 10"

Parametriumklemmen  
 Parametrium Clamps  
 Pinza para parametrio  
 Pinza per parametrio



ELGEN  
 21 cm 8 1/4"



EV13610-21



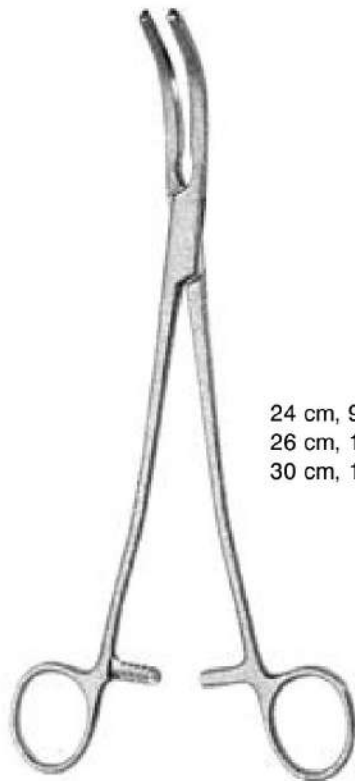
EV13611-21



EV13612-21



EV13613-21



ELGEN



24 cm, 9 1/2"  
 26 cm, 10 1/4"  
 30 cm, 12"  
 EV13620-24  
 EV13620-26  
 EV13620-30



EV13621-24  
 EV13621-26  
 EV13621-30

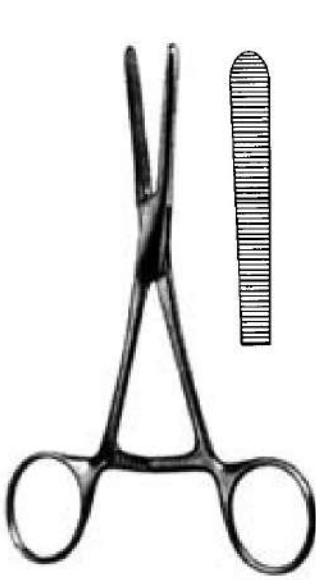


EV13622-24  
 EV13622-26  
 EV13622-30



EV13623-24  
 EV13623-26  
 EV13623-30

Schlauchklemmen  
Tubing Clamps  
Pinzas cierra-tubos  
Pinze serratubi



KLINIKUM BERLIN  
EV13702-14  
14,5 cm, 5 3/4"



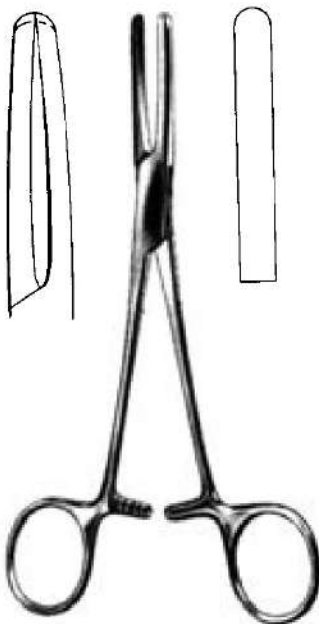
EV13710-15  
15 cm, 6"



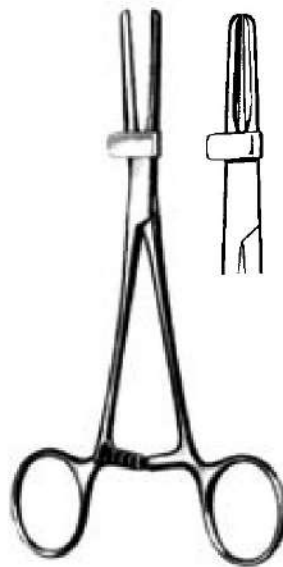
EV13710-18  
18 cm, 7"



EV13710-20  
20 cm, 8"



PRESBYTERIAN  
EV13704-16 16 cm, 6 1/4"  
EV13704-18 18 cm, 7"



EV13712-15  
15 cm, 6"



EV13712-18  
18 cm, 7"



EV13712-20  
20 cm, 8"



Rollenklemme  
Tube milking rollers  
Pinza de rodillos  
Pinze con rotelle



BÜLOW-GUNAR-HEY  
EV13720-18 18 cm, 7"



Rollenklemme  
Tube milking rollers  
Pinza de rodillos  
Pinze con rotelle



EV13730-16 16,5 cm, 6 1/2"



Tuchklemmen  
Towel Forceps  
Pinzas de campos  
Pinze fissateli



SCHAEDDEL  
EV15101-09  
9 cm, 3 1/2"

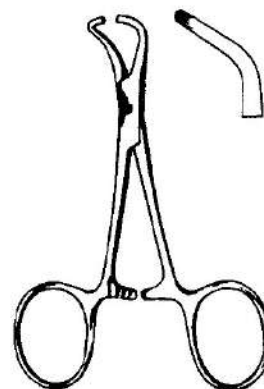


JONES  
EV15103-07  
7 cm, 2 3/4"

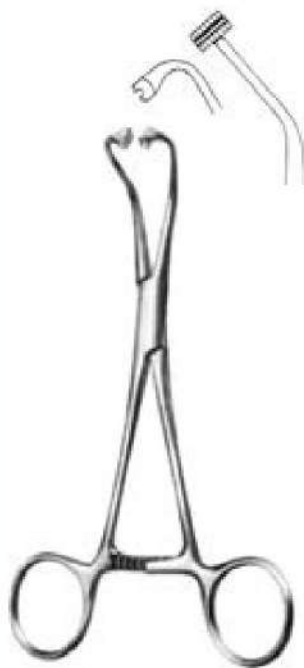


JONES-CLIP  
EV15105-09  
9 cm, 3 1/2"

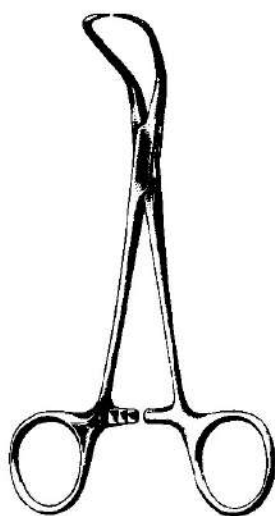
EV15103-09  
9 cm, 3 1/2"



TOHUKU  
EV15107-10 10 cm, 4"  
EV15107-13 13 cm, 5 1/8"



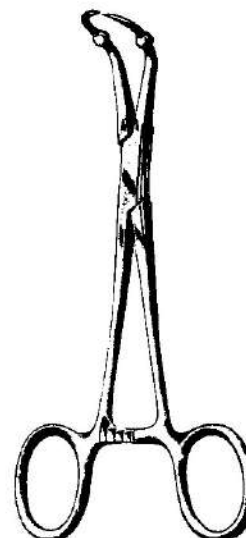
PEERS  
EV15108-14  
14,5 cm, 5 3/4"



BACKHAUS  
EV15111-09 9 cm, 3 1/2"  
EV15111-11 11 cm, 4 3/8"  
EV15111-13 13 cm, 5 1/8"  
EV15111-15 15 cm, 6"



BACKHAUS-CLIP  
EV15115-11  
11 cm, 4 3/8"



ROEDER  
EV15117-13  
13 cm, 5 1/8"

Tuchklemmen  
Towel Forceps  
Pinzas de campos  
Pinze fissateli



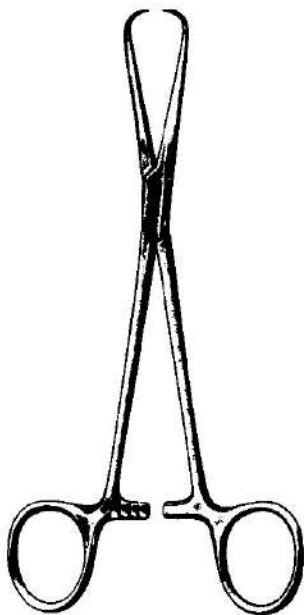
LORNA  
EV15121-11 11 cm, 4 <sup>3</sup>/<sub>8</sub>"  
EV15121-13 13 cm, 5 <sup>1</sup>/<sub>8</sub>"



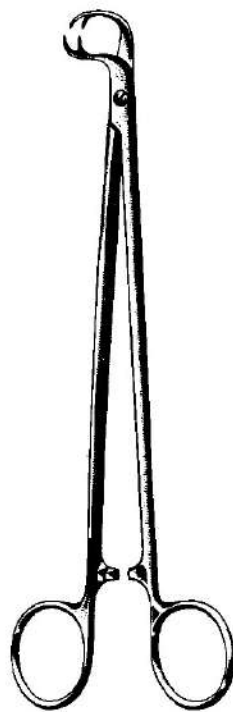
BALL AND SOCKET  
EV15123-11 11 cm, 4 <sup>3</sup>/<sub>8</sub>"  
EV15123-13 13 cm, 5 <sup>1</sup>/<sub>8</sub>"



EV15125-14  
14,5 cm, 5 <sup>3</sup>/<sub>4</sub>"



BERNHARD  
EV15140-16  
16,5 cm, 6 <sup>1</sup>/<sub>2</sub>"



MOYNIHAN  
EV15150-19  
19 cm, 7 <sup>1</sup>/<sub>2</sub>"

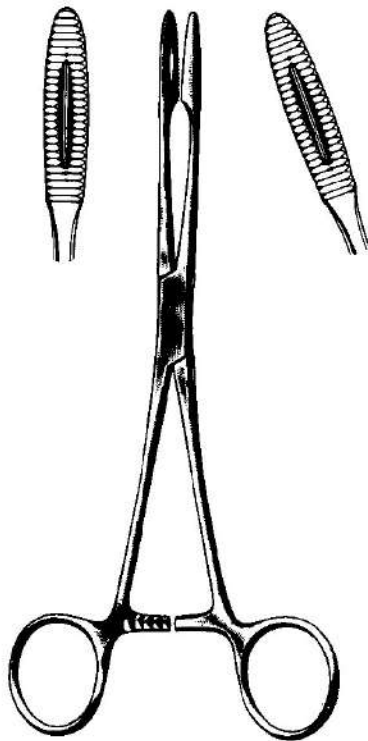


DOYEN  
EV15161-18  
18 cm, 7"

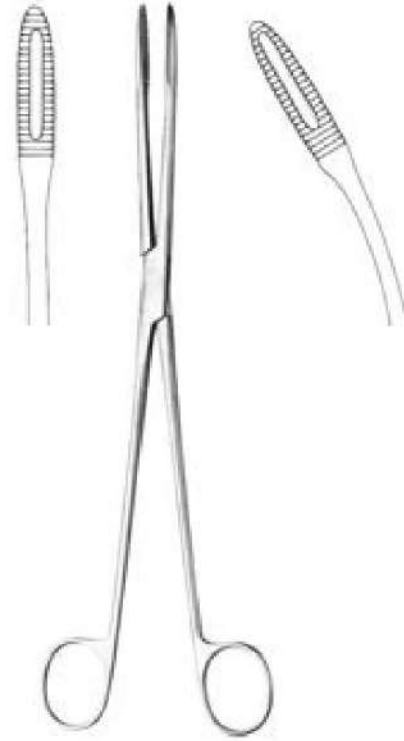


LANE  
EV15164-15 15 cm, 6"  
EV15164-20 20 cm, 8"

Tupfer- und Kornzangen  
 Dressing Forceps  
 Pinzas para tampones y curaciones  
 Pinze per tamponi e per medicazione



GROSS-MAIER  
 EV17110-20 20 cm, 8" EV17111-20  
 EV17110-25 25 cm, 10" EV17111-25



GROSS-MAIER  
 EV17112-20 20 cm, 8" EV17113-20  
 EV17112-25 25 cm, 10" EV17113-25



EV17120-28

EV17121-28



SIMS-MAIER  
 28 cm, 11"

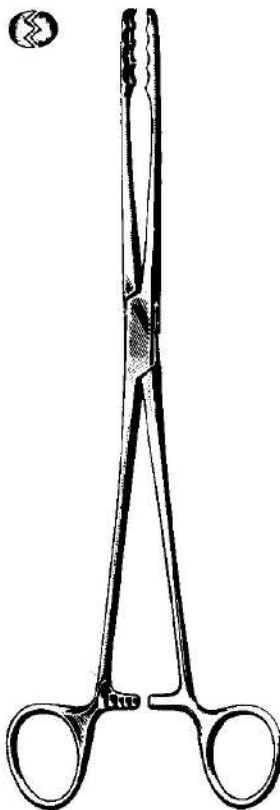


DUPLAY  
 EV17131-21 21 cm, 8 1/4"

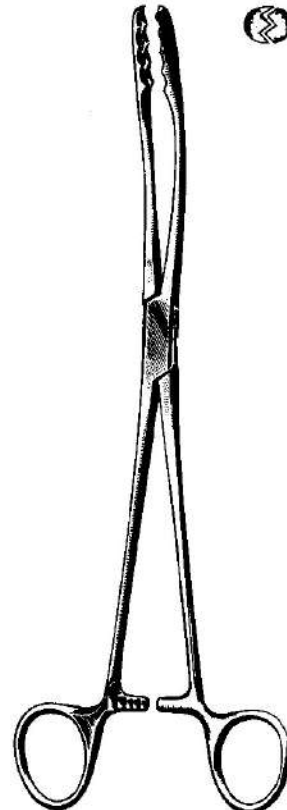
Tupfer- und Kornzangen  
 Dressing Forceps  
 Pinzas para tampones y curaciones  
 Pinze per tamponi e per medicazione



EV17133-17 17 cm, 6 3/4"

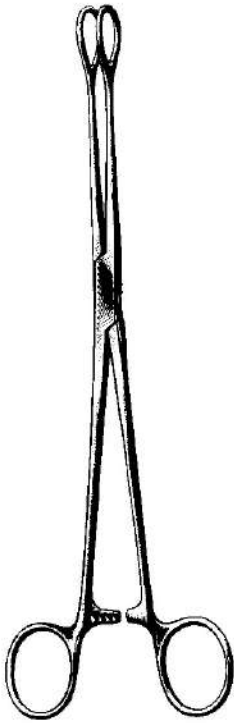


ULRICH  
 EV17160-22 22 cm, 8 3/4"  
 EV17160-25 25 cm, 10"

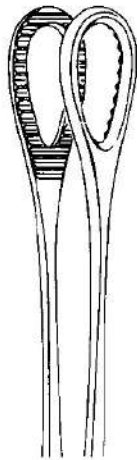


ULRICH  
 EV17161-22 22 cm, 8 3/4"  
 EV17161-25 25 cm, 10"

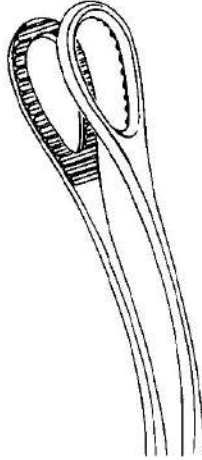
Schwammzange  
Sponge Forceps  
Pinzas porta-esponjas  
Pinze per spugne



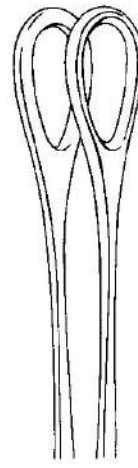
FOERSTER



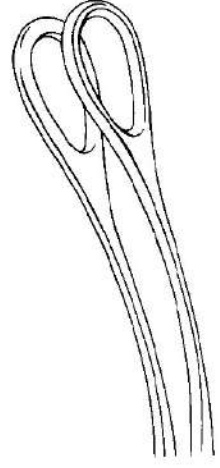
EV17170-18  
EV17170-20  
EV17170-25  
EV17170-30



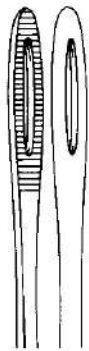
EV17171-18 18 cm, 7"  
EV17171-20 20 cm, 8"  
EV17171-25 25 cm, 10"



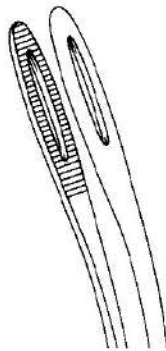
EV17172-18  
EV17172-25



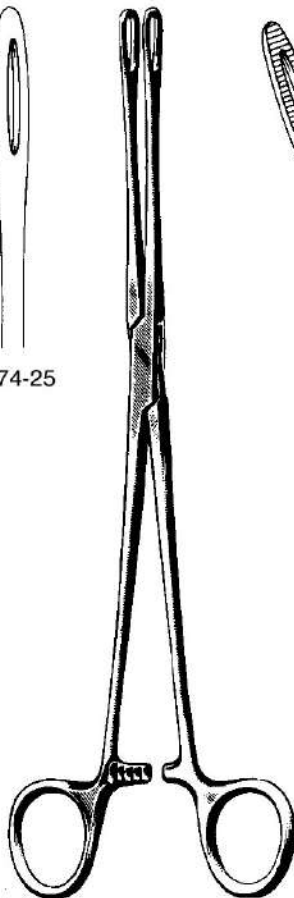
EV17173-18  
EV17173-25



EV17174-25



EV17175-25



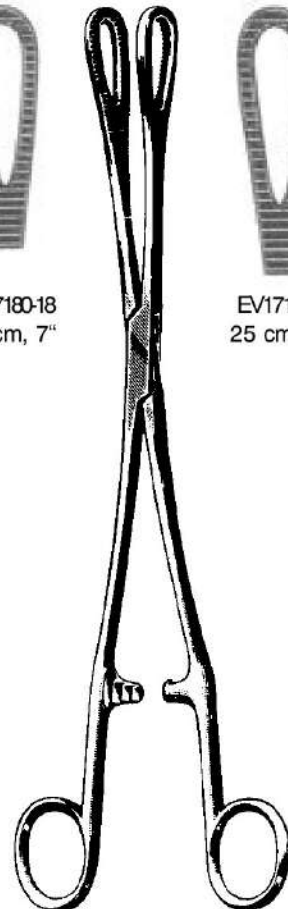
FOERSTER  
25 cm, 10"



EV17180-18  
18 cm, 7"



EV17180-25  
25 cm, 10"



RAMPLEY

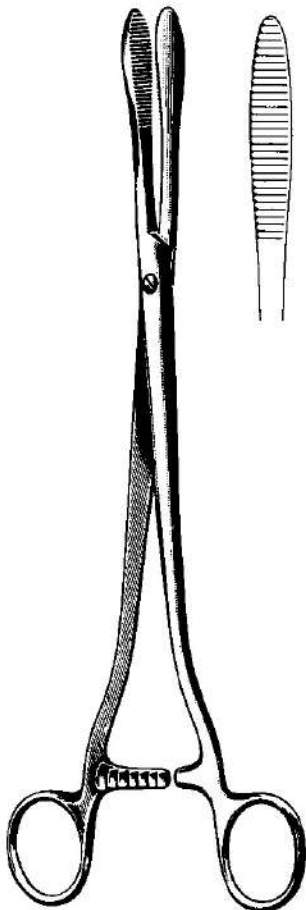
Kornzangen, Sinusklemmen  
 Dressing Forceps, Sinus Forceps  
 Pinzas para vendajes  
 Pinze per medicature, Pinze per seni



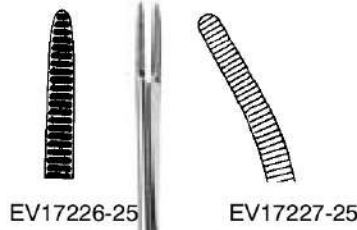
**BRYANT**  
 EV17207-13 13 cm, 5 1/8"



**LISTER (Sinus)**  
 EV17210-13 13 cm, 5 1/8"  
 EV17210-16 16 cm, 6 1/4"  
 EV17210-18 18 cm, 7"



**COLLIN**  
 EV17220-25 25 cm, 10"



EV17226-25

EV17227-25

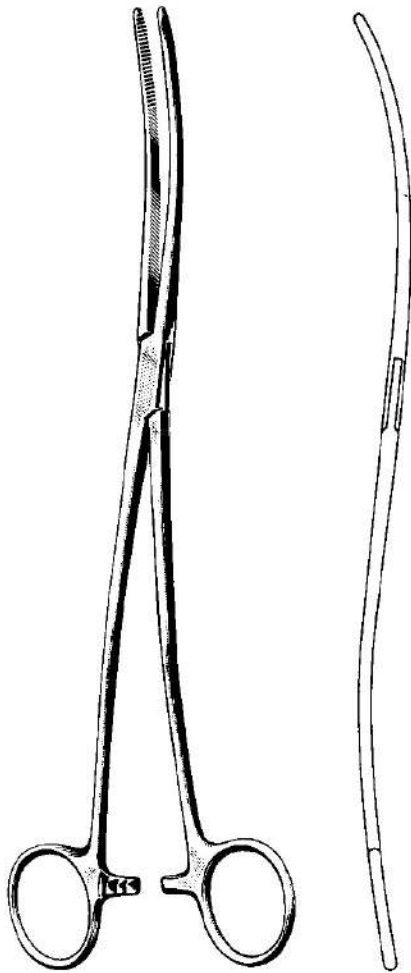


**PELKMANN**  
 25 cm, 10"

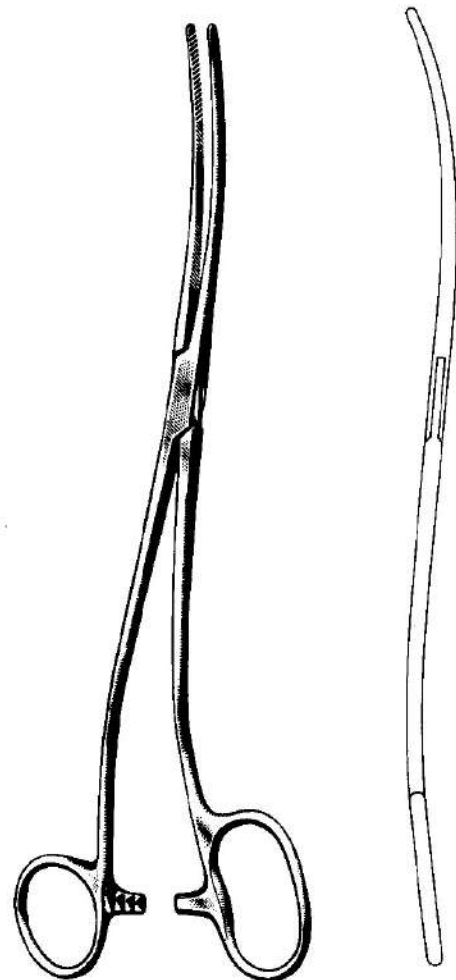


**CHERON**  
 EV17229-25 25 cm, 10"

Tamponzangen  
Dressing Forceps  
Pinzas para tapones  
Pinze per tamponi

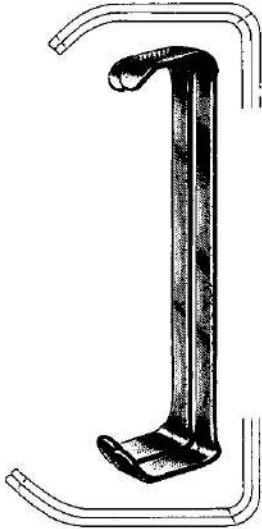


—BOZEMANN—  
EV17230-26 EV17231-26  
26 cm, 10 1/4"

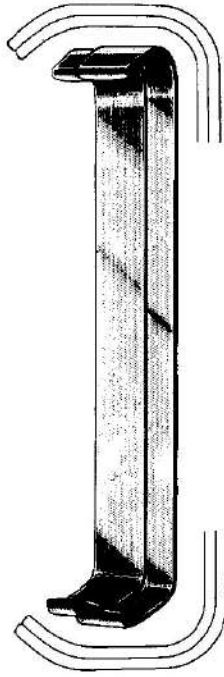


BOZEMANN-DOUGLAS  
EV17233-26  
26 cm, 10 1/4"

Satz, set, juego, serie



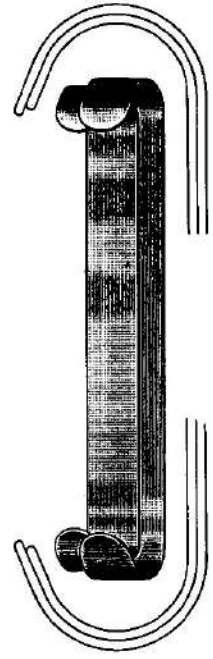
FARABEU  
EV19102-12  
12 cm, 4 3/4"



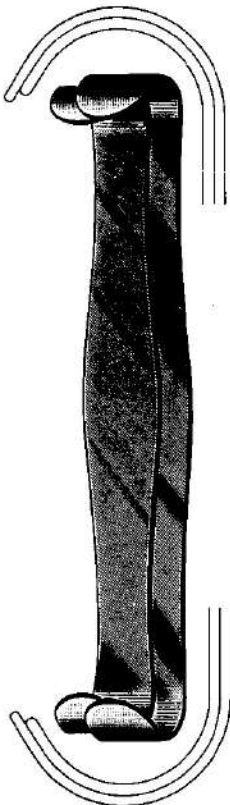
FARABEU  
EV19102-15  
15 cm, 6"



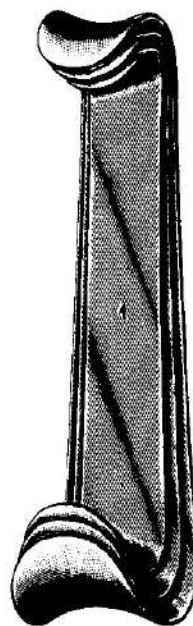
COLLIN  
EV19104-15  
15 cm, 6"



PARKER  
EV19110-13  
13,5 cm, 5 1/4"



PARKER  
EV19110-18 18 cm, 7"



ROUX  
EV19120-00

Fig. 1 = 24x20 mm  
Fig. 2 = 29x26 mm  
Fig. 3 = 35x29 mm

Fig. 1 = 30x28 mm  
Fig. 2 = 36x36 mm  
Fig. 3 = 38x43 mm

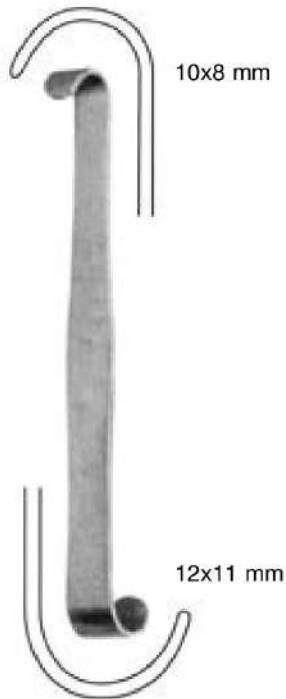
EV19120-14 Fig. 1 14 cm, 5 1/2"  
EV19120-15 Fig. 2 15 cm, 6"  
EV19120-17 Fig. 3 17 cm, 6 3/4"



Wundhaken  
Retractors  
Separadores  
Divaricatori



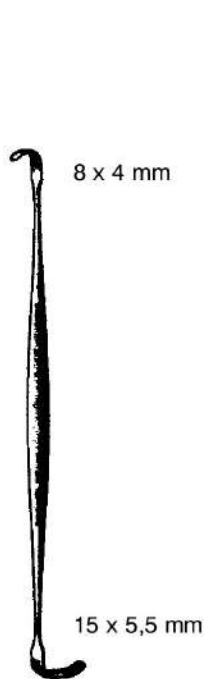
**ROUX BABY**  
EV19122-13  
13 cm, 5 1/8"



**LUER**  
EV19123-11  
11 cm, 4 3/8"



**ROUX mini**  
EV19124-15  
14 cm, 5 1/2"



**RAGNELL**  
EV19125-14  
14 cm, 5 1/2"



**ROSE**  
EV19126-13  
13 cm, 5 1/8"



**CRILE**  
EV19127-11  
11,5 cm, 4 1/2"

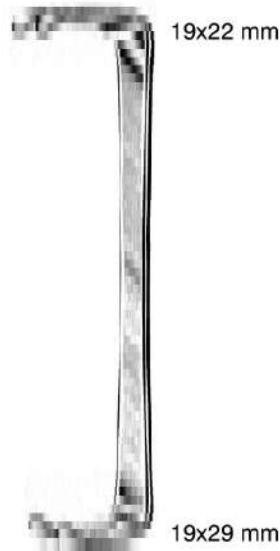
Wundhaken  
Retractors  
Separadores  
Divaricatori



Fig. 2 = 25x15 mm  
Fig. 1 = 21x15 mm

Fig. 1 = 40x15 mm  
Fig. 2 = 45x15 mm

US ARMY / Parker-Langenbeck  
EV19131-21 21 cm, 8 1/4"



19x22 mm

19x29 mm

MAYO-COLLINS  
EV19132-15 15 cm, 6"



Fig. 2 = 47x13 mm  
Fig. 1 = 42x13 mm

Fig. 1 = 42x26 mm  
Fig. 2 = 46x26 mm

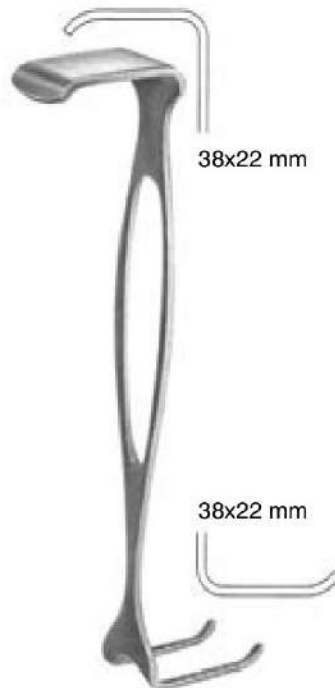
MATHIEU  
EV19134-20 20 cm, 8"



37x40 mm

30 x 31 mm

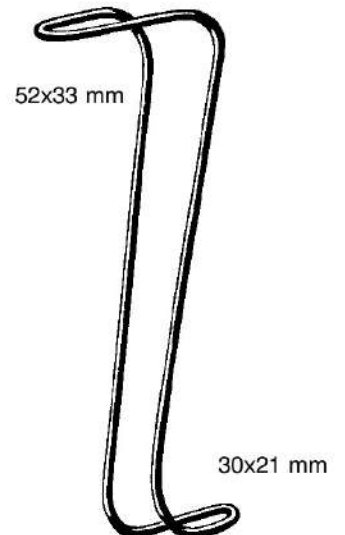
GOELET  
EV19135-19 19 cm, 7 1/2"



38x22 mm

38x22 mm

CZERNY  
EV19136-20 17,5 cm, 6.9"

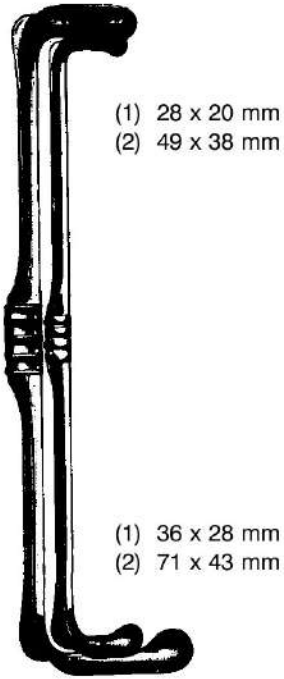


52x33 mm

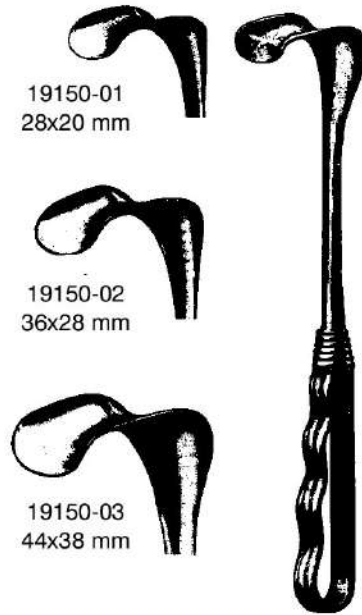
30x21 mm

COLLIN-HARTMANN  
EV19137-16 16 cm, 6 1/4"

Wundhaken  
Retractors  
Separadores  
Divaricatori



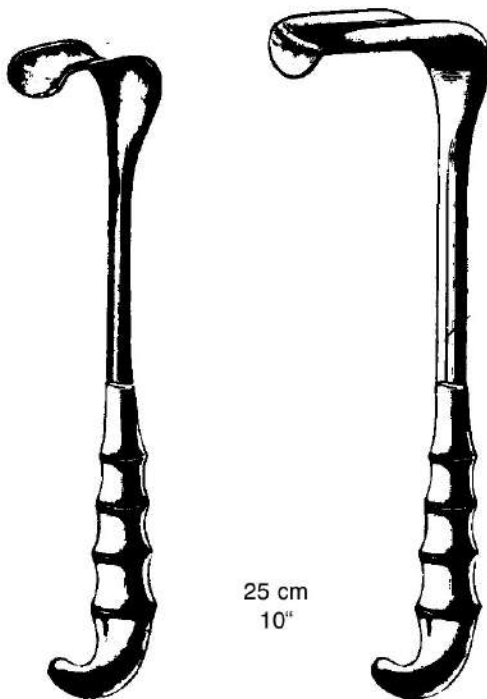
RICHARDSON-EASTMAN (Set)  
EV19140-00  
(1) EV19140-01 26 cm, 10 1/4"  
(2) EV19140-02 28 cm, 11"



RICHARDSON  
24 cm, 9 1/2"

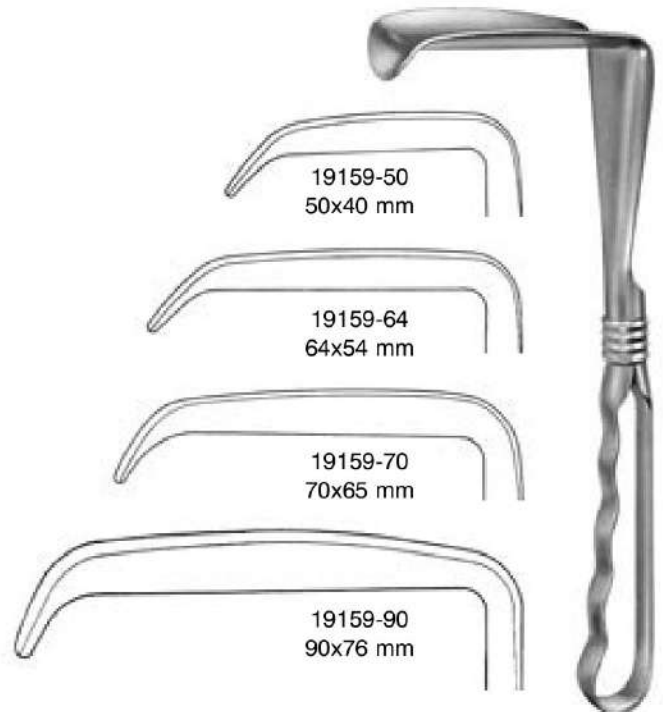


RICHARDSON  
EV19150-04  
24 cm, 9 1/2"

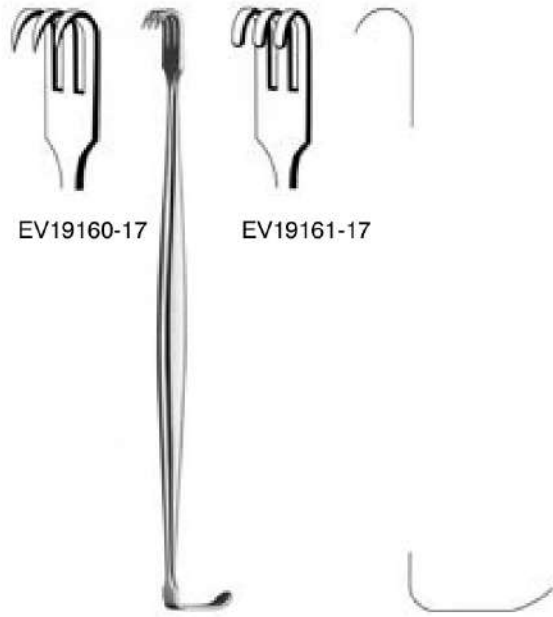


RICHARDSON GRIP  
EV19152-25 20x25 mm  
EV19152-31 25x31 mm  
EV19152-38 38x38 mm  
EV19152-51 19x51 mm  
EV19152-64 41x64 mm

KELLY GRIP  
EV19158-51 38x51 mm  
EV19158-64 51x64 mm  
EV19158-76 64x76 mm  
EV19158-82 70x82 mm



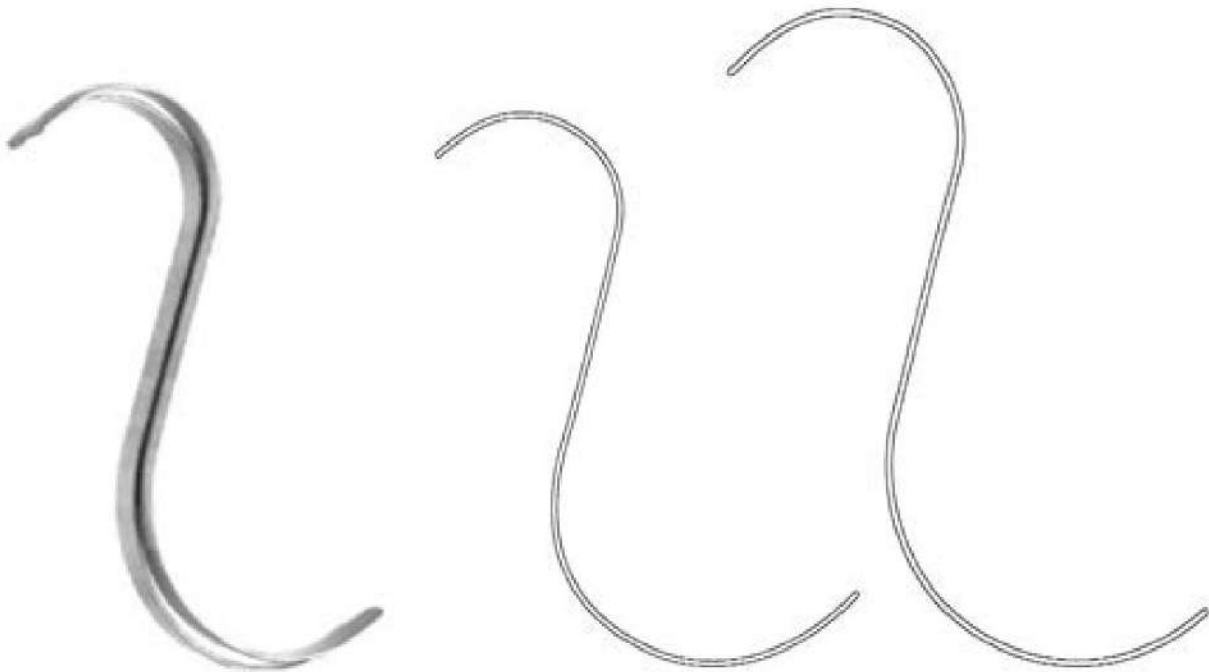
KELLY  
26 cm, 10 1/4"



EV19160-17

EV19161-17

SENN-MILLER  
17 cm, 6 <sup>3</sup>/<sub>4</sub>"



HASSON

Satz, set, juego, serie

EV19162-10 10 mm  
16 cm, 6 <sup>1</sup>/<sub>4</sub>"

EV19162-13 13 mm  
18 cm, 7"

Bauch- und Darmspatel  
Abdominal and intestinal spatulas  
Separadores, espátula intestinal y abdominal  
Divaricatori, spatole addominali e intestinali

biegsam, malleable, maleable, malleabili



RIBBON

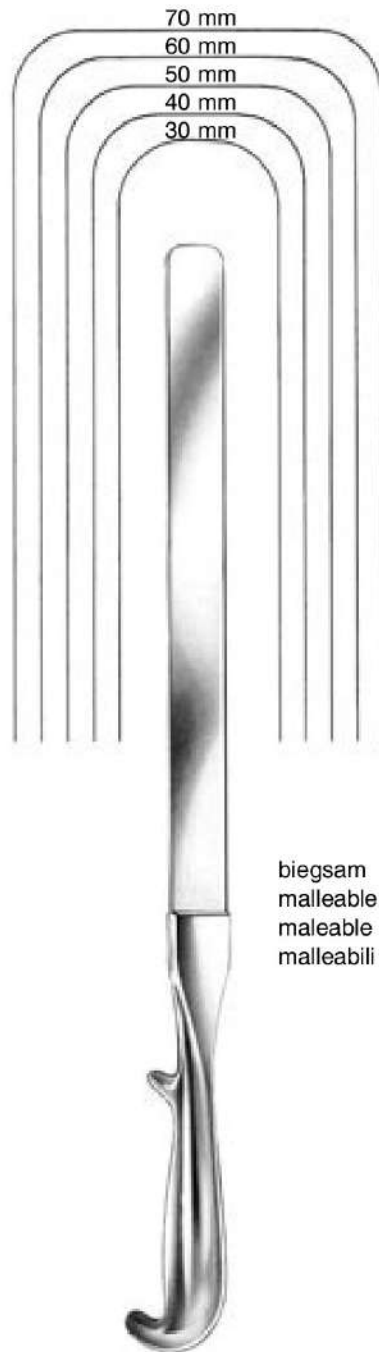
EV19168-06 6x200 mm  
EV19168-08 8x200 mm  
EV19168-10 10x200 mm  
EV19168-12 12x200 mm  
EV19168-17 17x200 mm  
EV19168-20 20x200 mm  
EV19168-25 25x200 mm  
EV19169-25 25x250 mm



RIBBON

EV19170-20 20x330 mm  
EV19170-25 25x330 mm  
EV19170-32 32x330 mm  
EV19170-40 40x330 mm  
EV19170-45 45x330 mm  
EV19170-50 50x330 mm  
EV19170-65 65x330 mm  
EV19170-76 76x330 mm

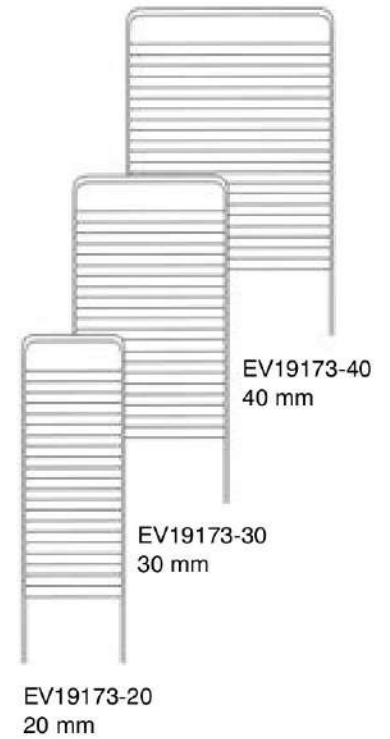
Bauch- und Darmspatel  
Abdominal and intestinal spatulas  
Separadores, espátula intestinal y abdominal  
Divaricatori, spatole addominali e intestinali



biegsam  
malleable  
maleable  
malleabili

41 cm, 16"  
EV19171-30 30 mm  
EV19171-40 40 mm  
EV19171-50 50 mm  
EV19171-60 60 mm  
EV19171-70 70 mm

Bauch- und Darmspatel  
 Abdominal and intestinal spatulas  
 Separadores, espátula intestinal y abdominal  
 Divaricatori, spatole addominali e intestinali

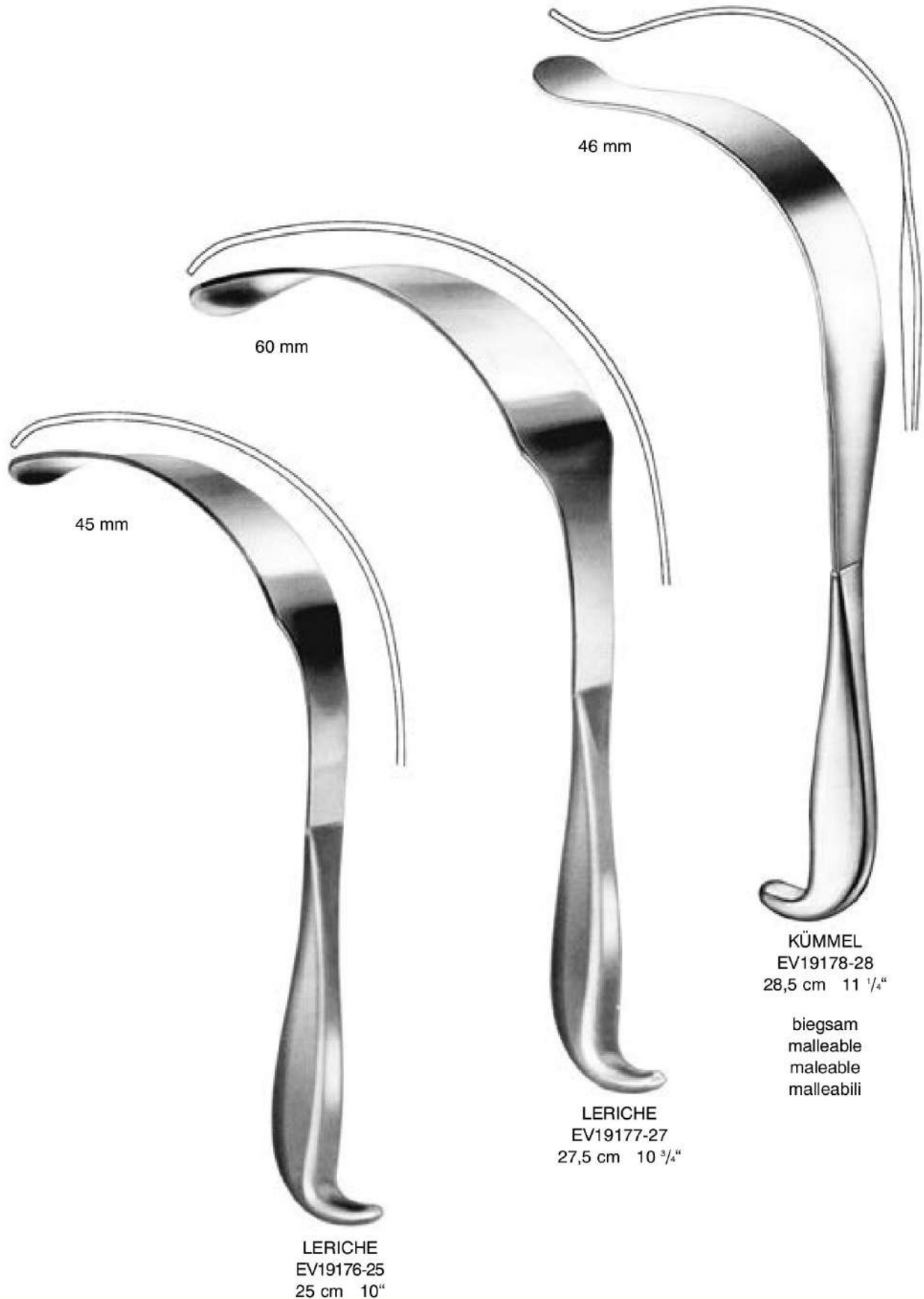


HABERER  
 EV19174-17 17/25x200 mm  
 EV19174-25 25/30x280 mm  
 EV19174-37 37/45x300 mm  
 EV19174-40 40/50x300 mm



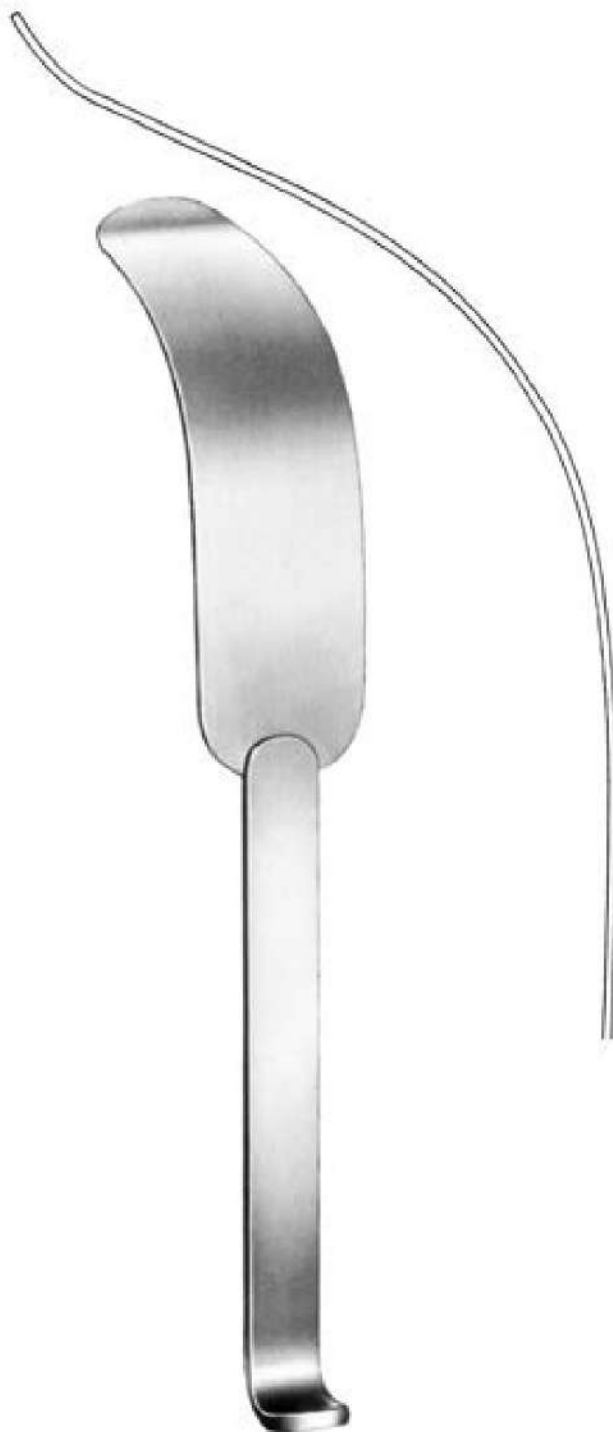
REVERDIN  
 EV19175-28  
 28 cm, 11"

Bauch- und Darmspatel  
Abdominal and intestinal spatula  
Separadores, espátula intestinal y abdominal  
Divaricatori, spatole addominali e intestinali





Bauchspatel  
Abdominal Spatulas  
Espátula abdominal  
Spatola addominale



KÜMME  
EV19179-28  
31 cm 12 1/4"



19 mm

DEAVER  
EV19180-19  
19 cm, 7 1/2"



22 mm

DEAVER  
EV19181-22  
21,5 cm, 8 1/2"



25 mm

DEAVER  
EV19181-25  
23 cm, 9"



25 mm

DEAVER  
EV19183-25  
30 cm, 11 3/4"



25 mm

DEAVER  
EV19185-25  
33 cm, 13"



25 mm

DEAVER  
EV19187-25  
36 cm, 14"



38 mm

DEAVER  
EV19187-38  
30 cm, 11 3/4"



50 mm

DEAVER  
EV19187-50  
31 cm 12 1/4"



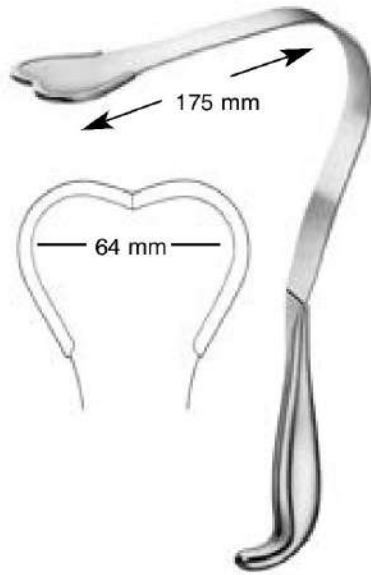
75 mm

DEAVER  
EV19187-75  
32 cm, 12 3/4"



DEAVER GRIP  
EV19189-25 25x310 mm  
EV19189-38 38x310 mm  
EV19189-50 50x310 mm  
EV19189-75 75x310 mm  
31 cm 12 1/4"

Wundhaken  
Retractors  
Separadores  
Divaricatori



HARRINGTON-PEMBERTON  
EV19190-64  
29,5 cm 11 3/4"



HARRINGTON  
EV19191-25 25x230 mm  
EV19191-40 40x320 mm  
EV19191-62 62x320 mm



64x60 mm

TUFFIER  
EV19192-23  
23 cm, 9"

30°  
rechts  
right  
a la derecha  
a destra

30°  
rechts, gerieft  
right serrated  
a la derecha, estriado  
a destra, zigrinato

30°  
links  
left  
a la izquierda  
a sinistra



45x48 mm

COOLEY  
EV19195-01  
24,5 cm, 9 3/4"



45x48 mm

COOLEY  
EV19195-02  
24,5 cm, 9 3/4"



24x48 mm

COOLEY  
EV19195-03  
25,5 cm, 10"



ROSS

flexibler Schaft  
flexible shaft  
vástago flexible  
asta flessibile



EV19196-01  
24 cm, 9 1/2"



EV19196-02  
24,5 cm, 9 3/4"



EV19196-03  
25 cm, 10"



EV19196-04  
25,5 cm, 10"

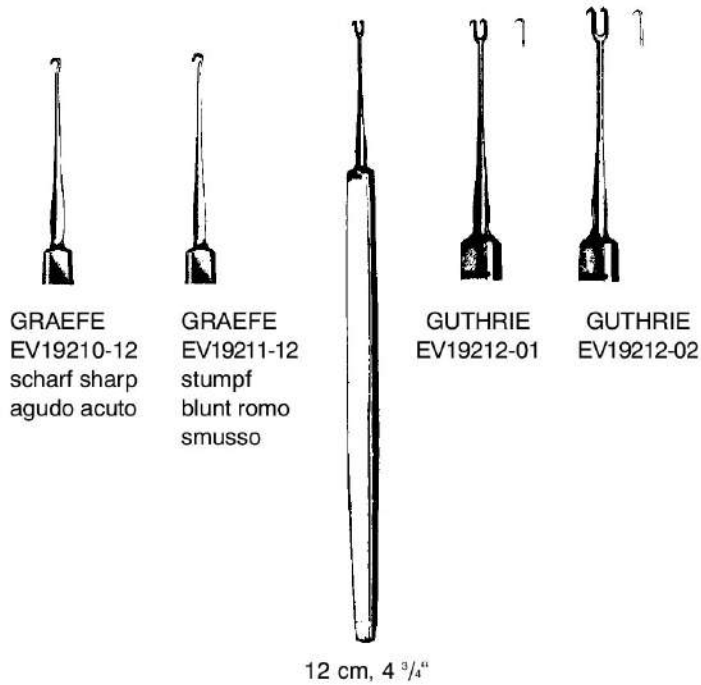


EV19196-05  
27 cm, 10 1/2"



EV19196-06  
25,5 cm, 10"

Hauthäkchen  
 Nerve and wound hooks  
 Ganchos y ganchitos para nervios  
 Uncini per nervi e divaricatori fini



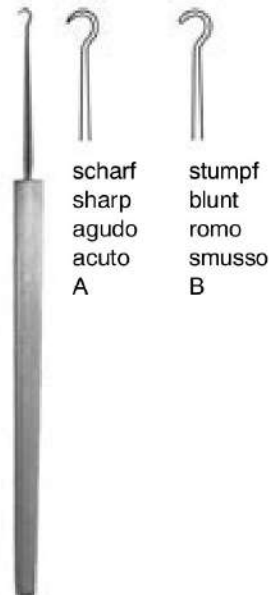
GRAEFE  
 EV19210-12  
 scharf sharp  
 agudo acuto

GRAEFE  
 EV19211-12  
 stumpf blunt  
 romo smusso

GUTHRIE  
 EV19212-01

GUTHRIE  
 EV19212-02

12 cm, 4 3/4"



scharf  
 sharp  
 agudo  
 acuto  
 A

stumpf  
 blunt  
 romo  
 smusso  
 B

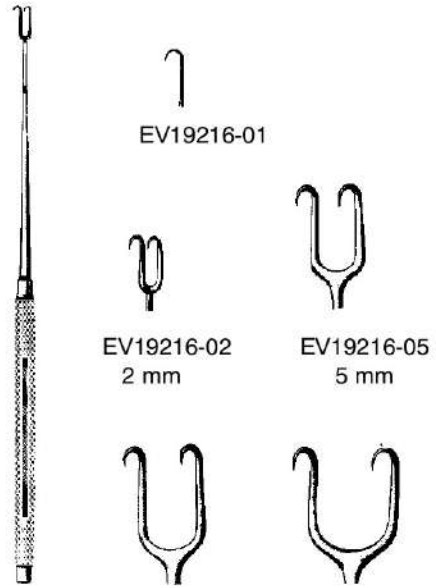
FRAZIER

- A EV19214-13 13 cm, 5" A
- EV19214-18 18 cm, 7" B
- EV19215-13 13 cm, 5" B
- EV19215-18 18 cm, 7"

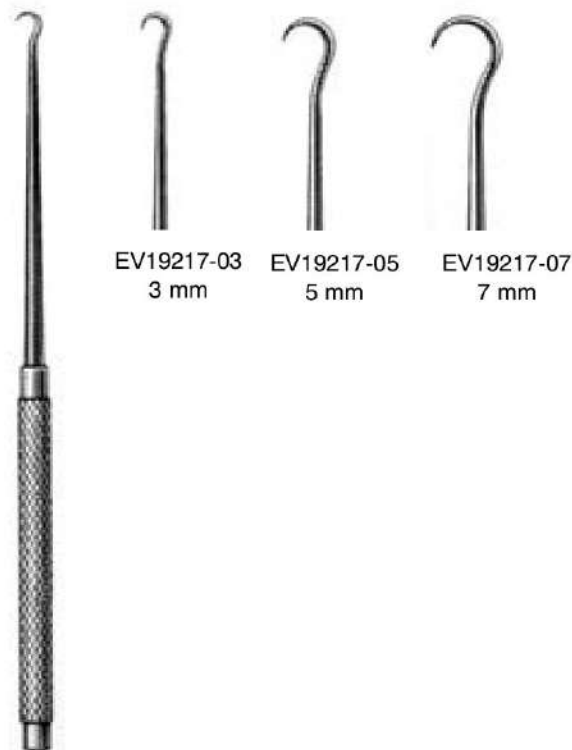
Hauthäkchen  
Nerve and wound hooks  
Ganchos y ganchitos para nervios  
Uncini per nervi e divaricatori fini



LAHEY  
12 cm, 4 3/4"



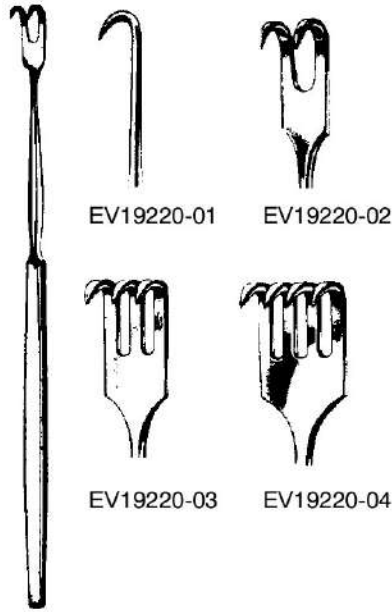
JOSEPH  
16 cm, 6 1/4"



KLEINERT-KUTZ  
13 cm, 5 1/8"



Hauthäkchen  
 Nerve and wound hooks  
 Ganchos y ganchitos para nervios  
 Uncini per nervi e divaricatori fini



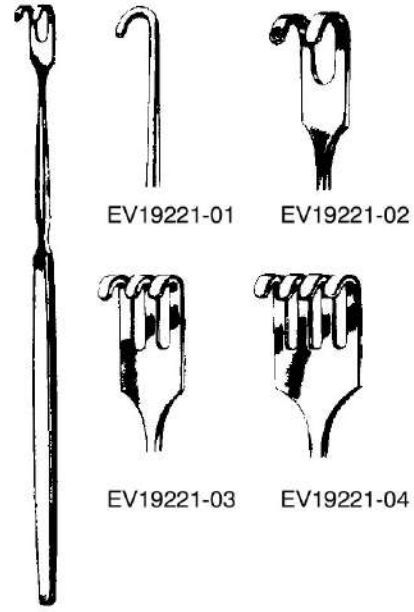
EV19220-01

EV19220-02

EV19220-03

EV19220-04

ELGEN  
 16 cm, 6 1/4"



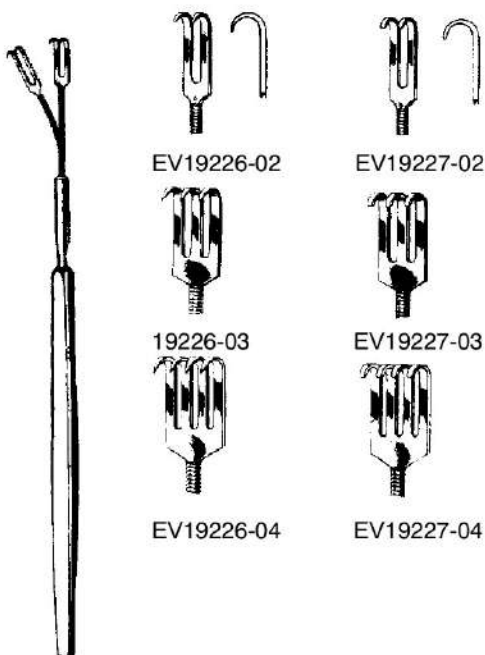
EV19221-01

EV19221-02

EV19221-03

EV19221-04

ELGEN  
 16 cm, 6 1/4"



EV19226-02

EV19227-02

19226-03

EV19227-03

EV19226-04

EV19227-04

ELGEN, flexibel  
 16 cm, 6 1/4"



EV19229-02

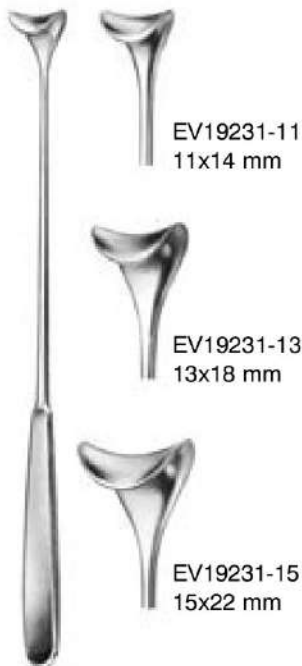
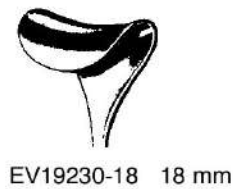
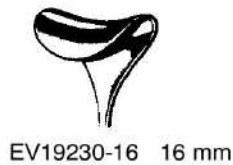
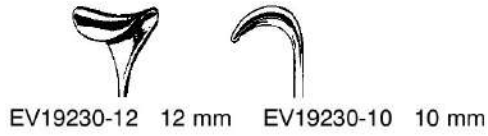
EV19229-03

KLAPP  
 17,5 cm, 6.9"

Sattelhäkchen  
Saddle Hooks  
Ganchos en forma de silla  
Divaricatori a forma di sella



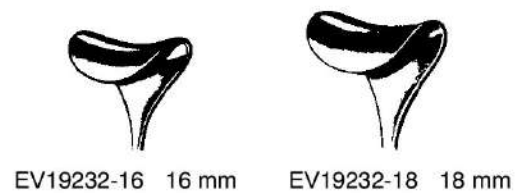
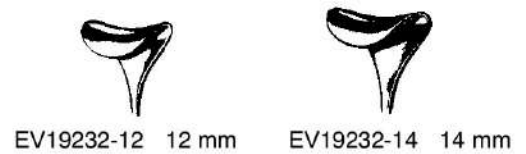
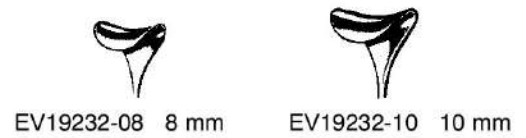
DESMARRES  
16 cm, 6 1/4"



CUSHING  
25 cm, 10"



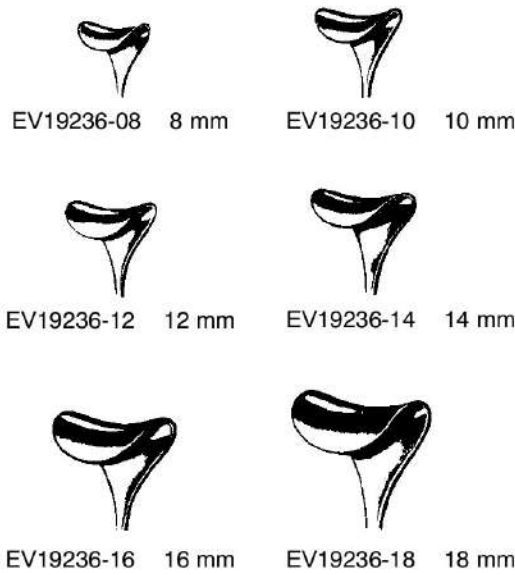
CUSHING  
20 cm, 8"



Sattelhäkchen  
 Saddle Hooks  
 Ganchos en forma de silla  
 Divaricatori a forma di sella



CUSHING  
 24 cm, 9 1/2"



GIL-VERNET  
 24 cm, 9 1/2"

biegsam  
 malleable  
 maleable  
 malleabile



EV19233-08 8 mm    EV19233-11 11 mm    EV19233-15 15 mm



EV19233-17 17 mm    EV19233-20 20 mm    EV19233-23 23 mm



CUSHING  
EV19234-20  
20 cm, 8"



CUSHING  
EV19235-21  
21,5 cm, 8 1/2"



EV19236-01  
13x13 mm



EV19236-02  
12x16 mm

KÖNIG  
18 cm, 7"



EV19240-10 10x6 mm

EV19240-20 20x6 mm

SENN-GREEN  
15 cm, 6"



EV19250-16  
16x6 mm



EV19250-24  
24x6 mm

LANGENBECK-GREEN  
16 cm, 6 1/4"



VOLKMANN  
11,5 cm, 4 1/2"



EV19270-02



EV19270-03



EV19270-04



EV19270-06



EV19271-02



EV19271-03



EV19271-04



EV19271-06

Wundhaken  
Retractors  
Separadores  
Divaricatori

GENERAL SURGICAL



EV19280-01



EV19280-02



EV19280-03



EV19280-04



EV19280-06



scharf  
sharp  
agudo  
acuto



EV19281-01



EV19281-02



EV19281-03



EV19281-04



EV19281-06



stumpf  
blunt  
romo  
smusso



EV19282-02



EV19282-03



EV19282-04



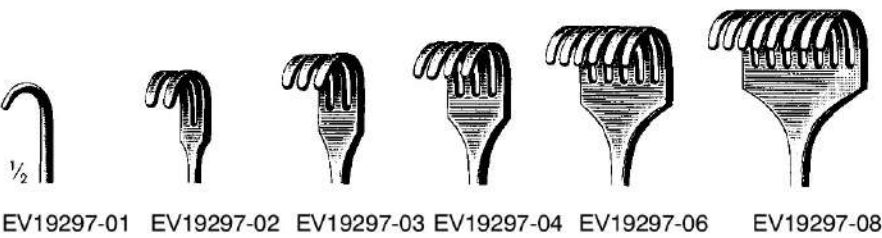
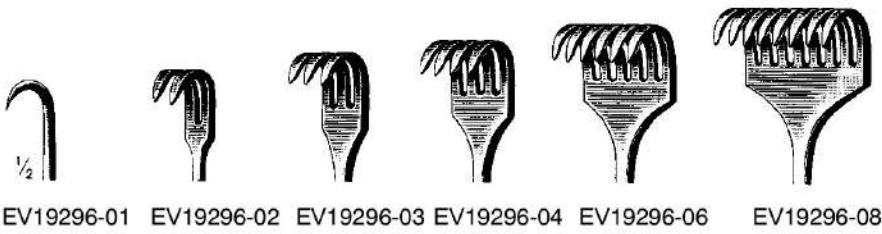
EV19282-06



halbscharf  
semi-sharp  
medio romo  
mezzo smusso

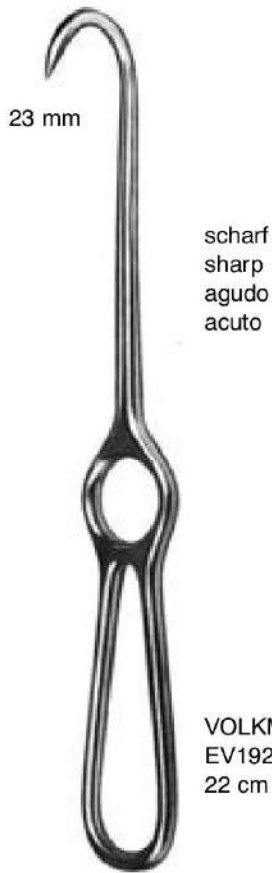


VOLKMANN  
21,5 cm, 8 1/2"

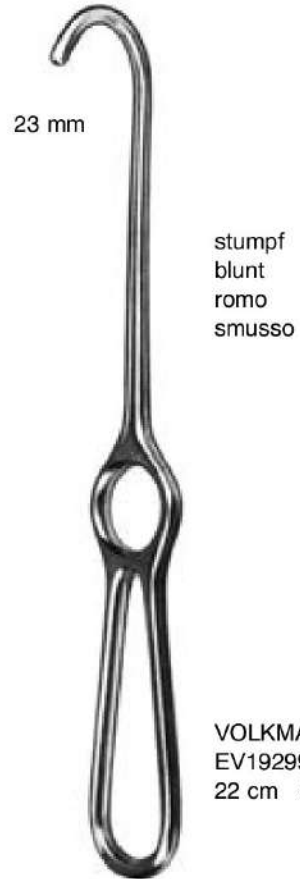


KOCHER  
22 cm, 8 3/4"

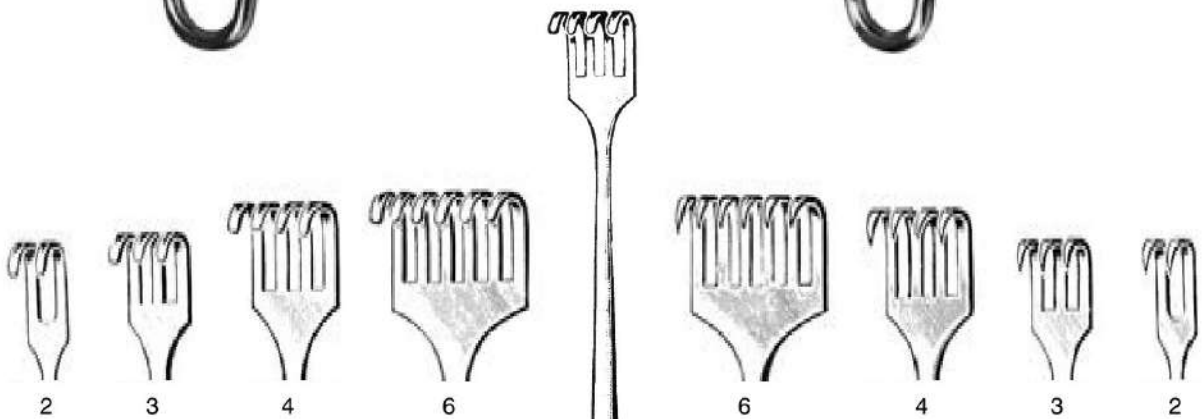
Wundhaken, Knochenhaken  
 Retractors, Bone Retractors  
 Separadores, Separadores oseos  
 Divaricatori, Divaricatori per ossa



VOLKMANN  
 EV19298-01  
 22 cm 8 3/4"



VOLKMANN  
 EV19299-01  
 22 cm 8 3/4"

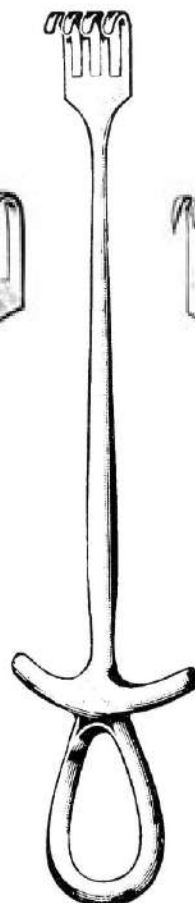


stumpf  
blunt  
romo  
smusso

- EV19301-02 8x 8 mm
- EV19301-03 8x13 mm
- EV19301-04 8x18 mm
- EV19301-06 8x28 mm

scharf  
sharp  
agudo  
acuto

- EV19300-02 8x 8 mm
- EV19300-03 8x13 mm
- EV19300-04 8x18 mm
- EV19300-06 8x28 mm



MURPHY  
 19,4 cm 7 5/8"



MEYERDING  
18 cm, 7"



EV19302-01 18x7 mm



EV19302-04 7x4 mm



EV19302-02 16x5 mm



EV19302-05 10x3 mm



EV19302-03 7x4 mm



EV19302-06 10x4 mm



28x6 mm



LAHEY  
EV19304-19  
19 cm, 7 1/2"



12x14 mm



LITTLE  
EV19306-20  
20 cm, 8"



STRANDELL-STILLE  
17 cm 6 3/4"

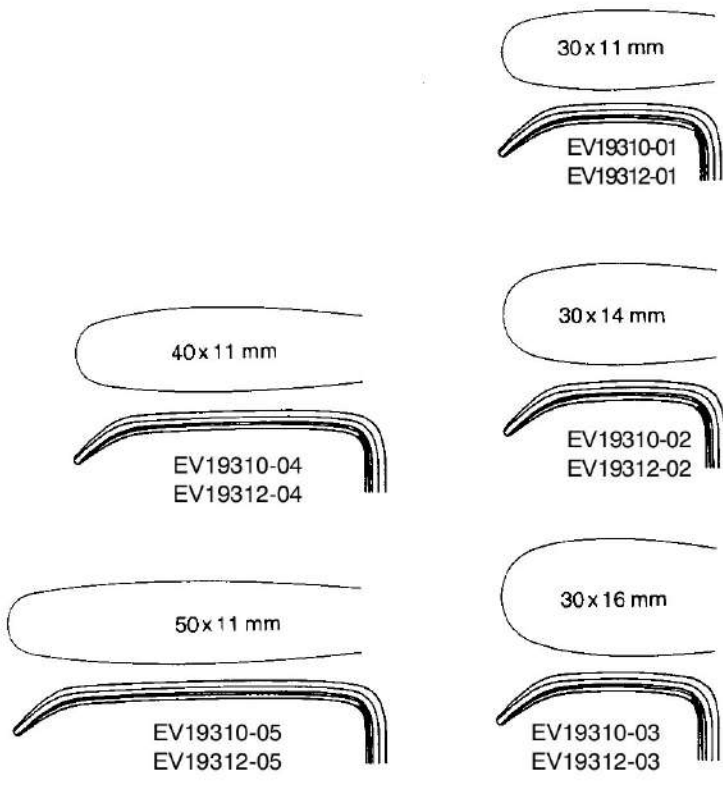


EV19307-01



EV19307-02



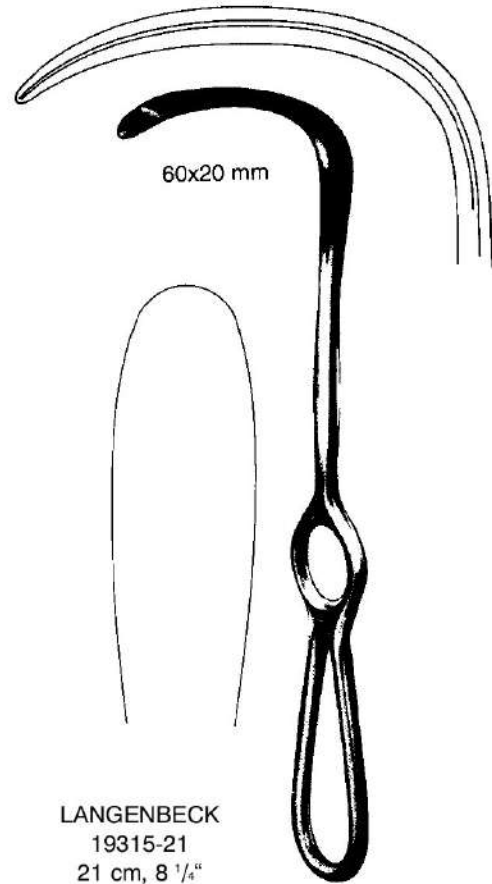


LANGENBECK  
EV19310-01 - EV19310-05  
22 cm, 8 3/4"

LANGENBECK  
EV19312-01 - EV19312-05  
21 cm, 8 1/4"

- EV19315-06 25x 6 mm
- EV19314-07 35x 7 mm
- EV19314-10 35x10 mm
- EV19314-12 80x12 mm
- EV19314-14 70x14 mm
- EV19314-15 35x15 mm
- EV19314-16 80x16 mm
- EV19314-20 60x20 mm
- EV19330-40 40x12 mm
- EV19330-55 55x11 mm

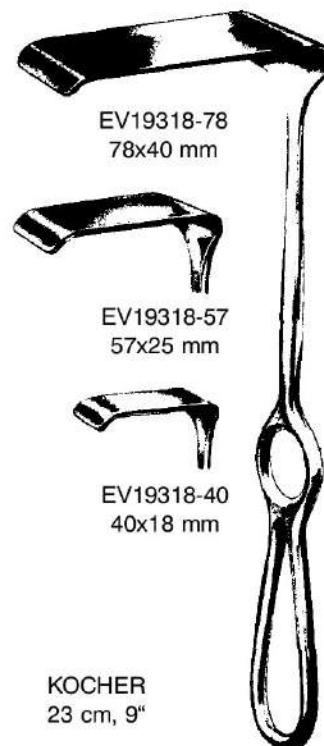
KOCHER-LANGENBECK  
21 cm, 8 1/4"



LANGENBECK  
19315-21  
21 cm, 8 1/4"

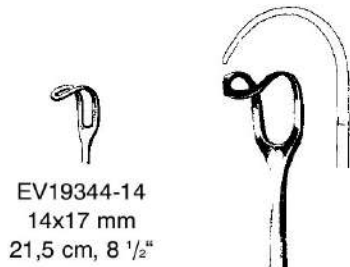


LANGENBECK  
EV19317-21  
21 cm, 8 1/4"

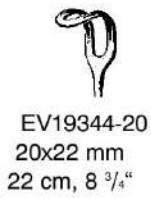


KOCHER  
23 cm, 9"

Wundhaken  
Retractors  
Separadores  
Divaricatori



EV19344-14  
14x17 mm  
21,5 cm, 8 1/2"



EV19344-20  
20x22 mm  
22 cm, 8 3/4"

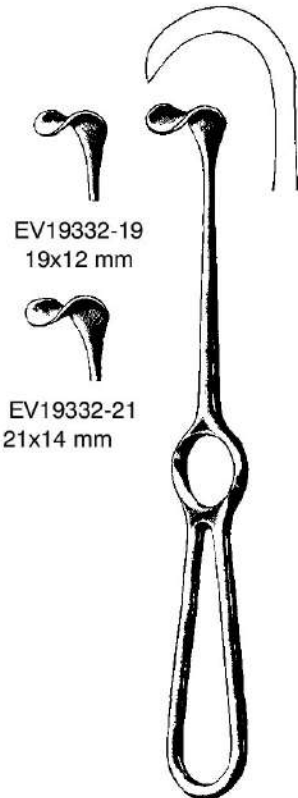


EV19344-26  
26x30 mm  
23,5 cm, 9 1/4"

MIDDELDORPF  
EV19344-14 - EV19344-26



KOCHER  
EV19340-10 40x10 mm  
EV19340-15 40x15 mm  
EV19340-20 40x20 mm  
22 cm, 8 3/4"



EV19332-19  
19x12 mm

EV19332-21  
21x14 mm

KOCHER  
EV19332-19 - EV19332-21  
19 cm, 7 1/2"



MIDDELDORPF  
EV19345-01 45x45 mm  
25,5 cm, 10"



EV19345-02  
45x50 mm



EV19345-03  
55x70 mm



GREEN  
EV19348-22  
22 cm, 8 3/4"

Wundhaken  
Retractors  
Separadores  
Divaricatori

35 x 8 mm



ZENKER  
EV19350-35  
25 cm, 10"

60 x 12 mm



ZENKER  
EV19350-60  
26 cm, 10 1/4"

75 x 12 mm

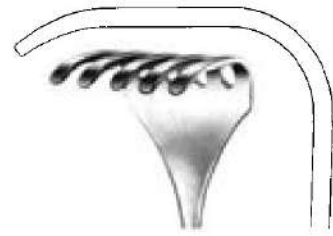


ZENKER  
EV19350-70  
27,5 cm, 10,8"

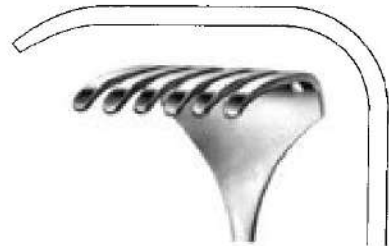
Wundhaken  
Retractors  
Separadores  
Divaricatori



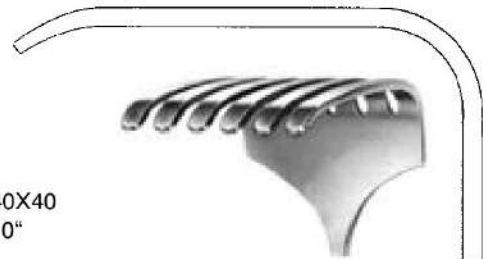
ISRAEL  
EV19364-40 40X40  
mm 25 cm, 10"



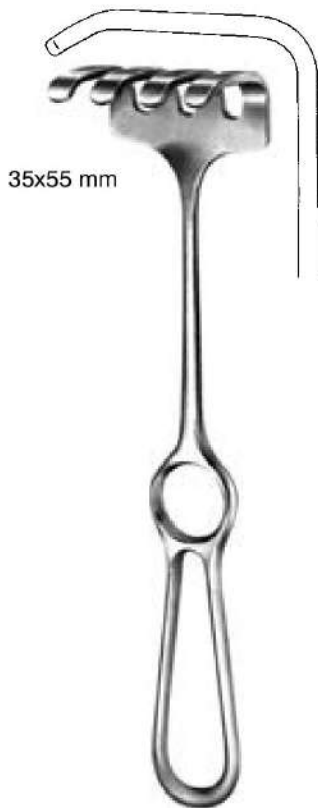
EV19364-50 45x50 mm



EV19364-60 50x60 mm



EV19364-70 70x70 mm



35x55 mm

OLLIER  
EV19360-04 22,5 cm, 8.9"



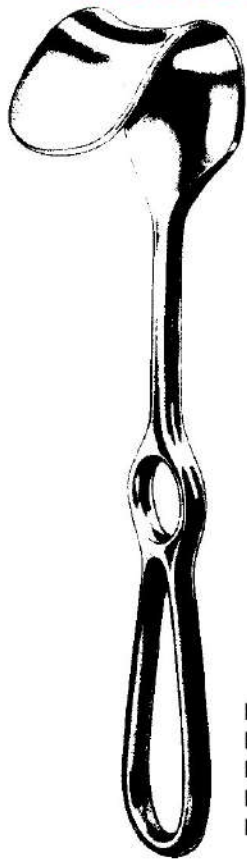
40x30 mm

spitz  
sharp  
agudo  
acuto

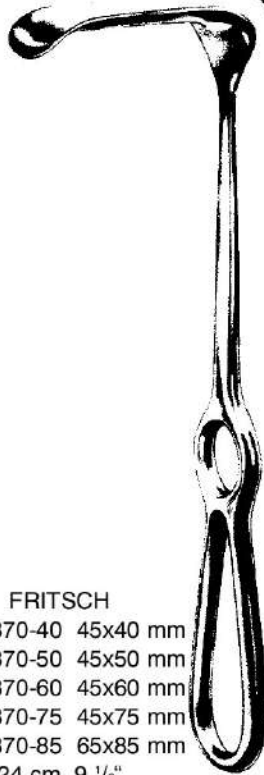
stumpf  
blunt  
romo  
smusso

KOERTE  
EV19366-08 23,5 cm, 9 1/4" EV19367-08

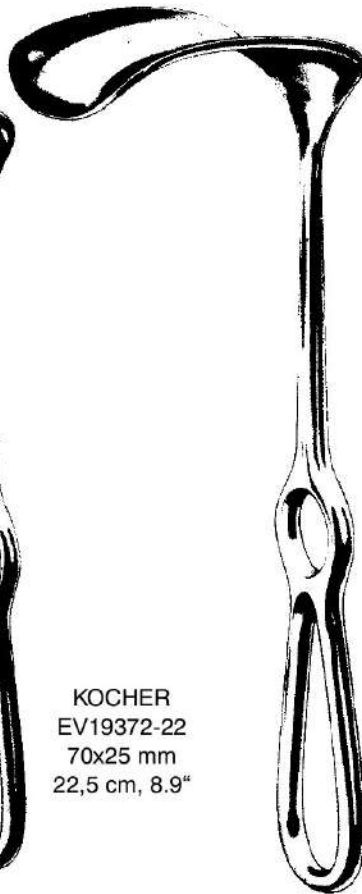
Wundhaken  
Retractors  
Separadores  
Divaricatori



**FRITSCH**  
EV19370-40 45x40 mm  
EV19370-50 45x50 mm  
EV19370-60 45x60 mm  
EV19370-75 45x75 mm  
EV19370-85 65x85 mm  
24 cm, 9 1/2"



**KOCHER**  
EV19372-22  
70x25 mm  
22,5 cm, 8.9"



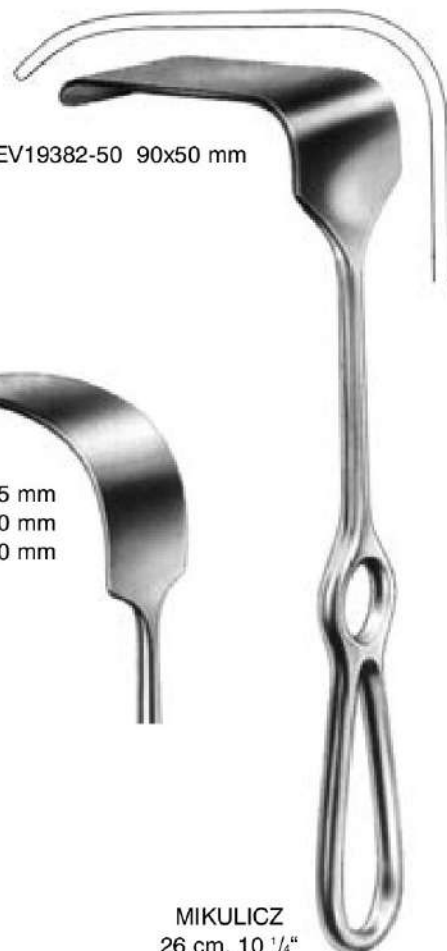
**KOCHER**  
EV19374-45 80x45 mm  
EV19374-55 80x55 mm  
EV19374-65 80x65 mm  
25 cm, 10"

50x85 mm



**DOYEN**  
EV19378-25  
25 cm, 10"

EV19382-50 90x50 mm



**MIKULICZ**  
26 cm, 10 1/4"

EV19380-35 95x35 mm  
EV19380-50 120x50 mm  
EV19381-50 150x50 mm



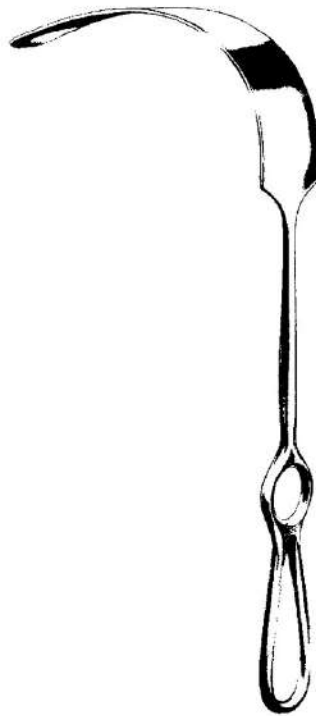
Wundhaken  
Retractors  
Separadores  
Divaricatori



EV19388-40 70x40 mm  
EV19388-50 70x50 mm  
EV19388-65 70x65 mm



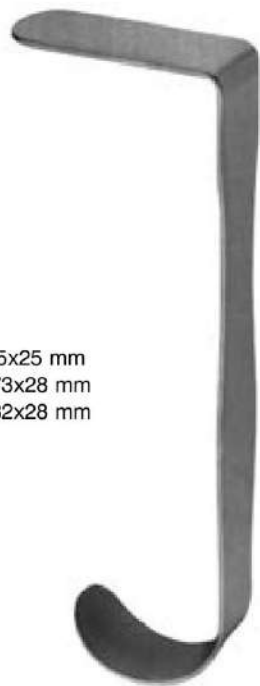
MORRIS  
24,5 cm  
9 3/4"



KELLY  
EV19385-38 160x38 mm  
EV19385-57 160x57 mm  
27 cm, 10 1/2"

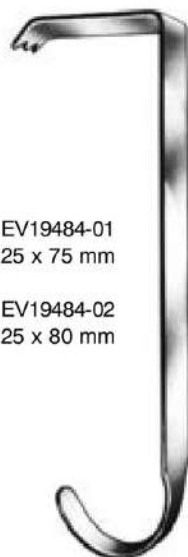


SIMON  
EV19480-22 115x22 mm  
EV19480-27 115x27 mm  
28 cm, 11"



EV19482-45 45x25 mm  
EV19482-73 73x28 mm  
EV19482-82 82x28 mm

HEANEY  
27 cm, 10 1/2"



EV19484-01  
25 x 75 mm  
EV19484-02  
25 x 80 mm

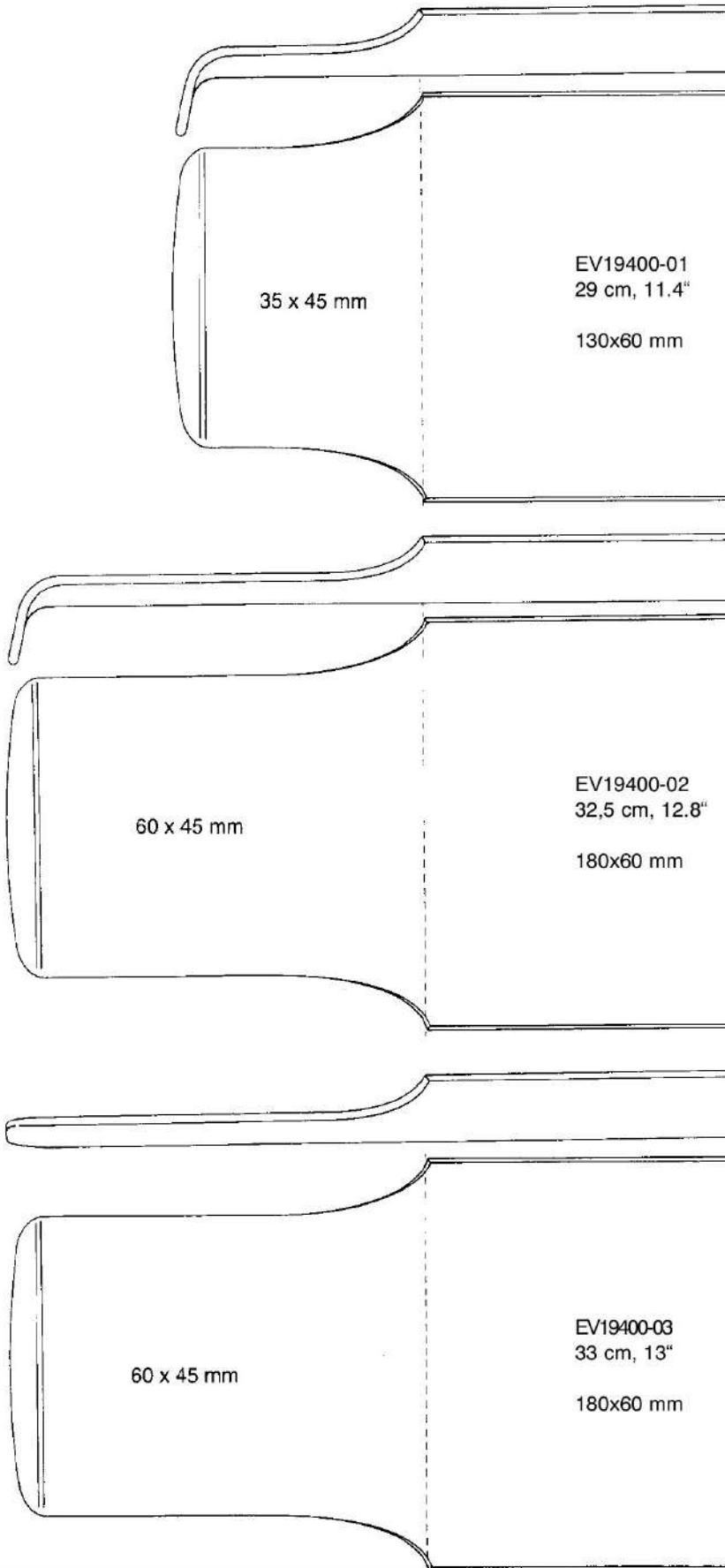
HIBBS  
24 cm, 9 1/2"



125x37 mm

SAUERBRUCH  
EV19492-25  
25 cm, 10"

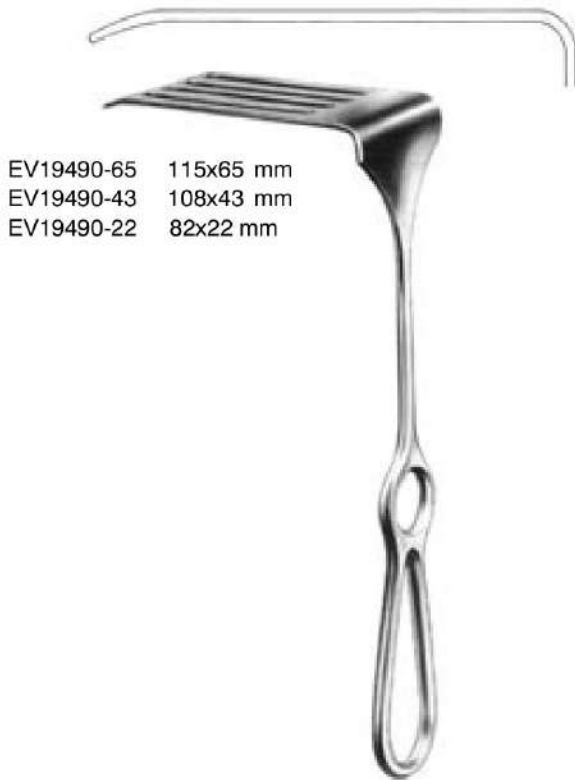
Pelvis-Haken  
 Pelvis retractor  
 Retractor de pelvis  
 Divaricatori pelvici



ST. MARKS  
 EV19400-01 EV19400-03

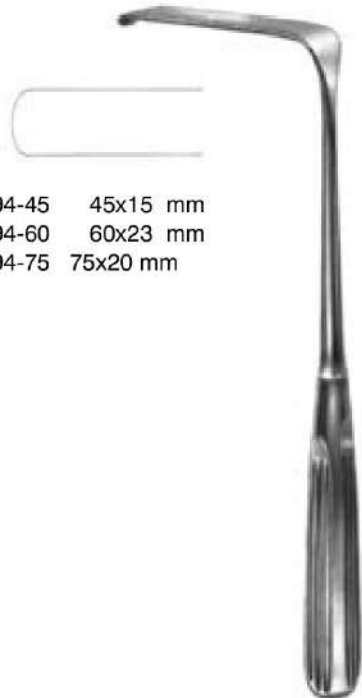


Wundhaken, Scapulahaken  
 Retractors, Scapula Retractors  
 Separadores, Separadores para escápula  
 Divaricatori, Divaricatori per scapola



EV19490-65 115x65 mm  
 EV19490-43 108x43 mm  
 EV19490-22 82x22 mm

CORYLLOS (Thorax)  
 24 cm, 9 1/2"



EV19494-45 45x15 mm  
 EV19494-60 60x23 mm  
 EV19494-75 75x20 mm

SAUERBRUCH  
 22,5 cm, 8.9"



DAVIDSON  
 EV19496-50 75x50 mm

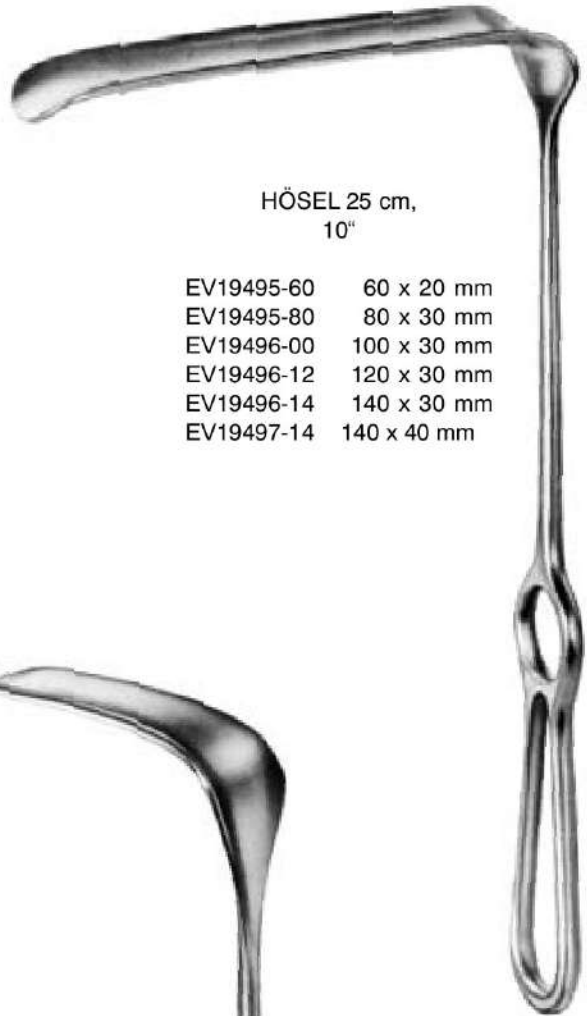


DAVIDSON  
 EV19496-90 75x90 mm



BRUNNER 25  
cm, 10"

|            |             |
|------------|-------------|
| EV19493-80 | 80 x 20 mm  |
| EV19494-00 | 100 x 25 mm |
| EV19494-12 | 120 x 25 mm |
| EV19494-13 | 130 x 30 mm |
| EV19494-14 | 140 x 30 mm |
| EV19494-16 | 160 x 30 mm |
| EV19494-18 | 180 x 30 mm |



HÖSEL 25 cm,  
10"

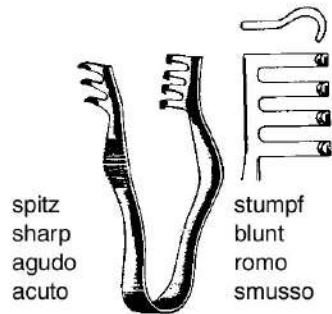
|            |             |
|------------|-------------|
| EV19495-60 | 60 x 20 mm  |
| EV19495-80 | 80 x 30 mm  |
| EV19496-00 | 100 x 30 mm |
| EV19496-12 | 120 x 30 mm |
| EV19496-14 | 140 x 30 mm |
| EV19497-14 | 140 x 40 mm |



DOYEN-STILLE 25  
cm, 10"

|            |             |
|------------|-------------|
| EV19498-01 | 97 x 29 mm  |
| EV19498-02 | 101 x 31 mm |
| EV19498-03 | 127 x 52 mm |

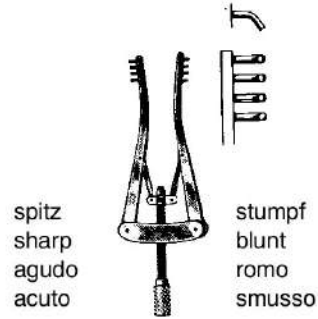
Wundsperrer, Kieferhöhlensperrer  
 Retractors, Antrum Retractor  
 Separadores, Separadores para seno maxilar  
 Divaricatori, Divaricatori per seno mascellare



spitz  
sharp  
agudo  
acuto

stumpf  
blunt  
romo  
smusso

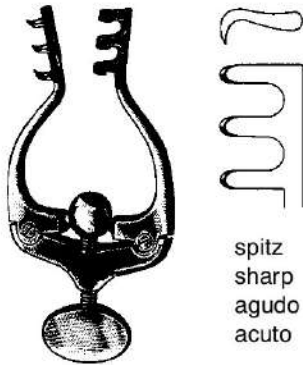
FINSEN  
 EV19610-07 7 cm, 2 3/4" EV19611-07



spitz  
sharp  
agudo  
acuto

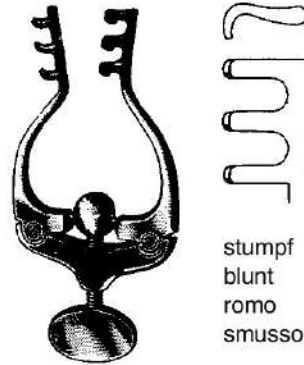
stumpf  
blunt  
romo  
smusso

ALM  
 EV19620-07 7 cm, 2 3/4" EV19621-07  
 EV19620-10 10 cm, 4" EV19621-10



spitz  
sharp  
agudo  
acuto

JANSEN  
 EV19630-10  
 10 cm, 4"



stumpf  
blunt  
romo  
smusso

JANSEN  
 EV19631-10  
 10 cm, 4"



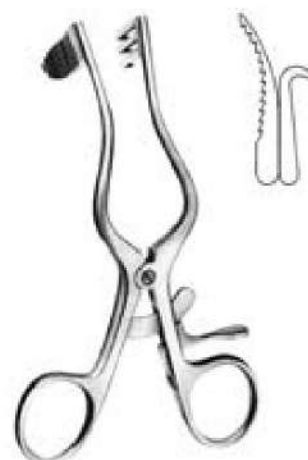
spitz  
sharp  
agudo  
acuto

stumpf  
blunt  
romo  
smusso

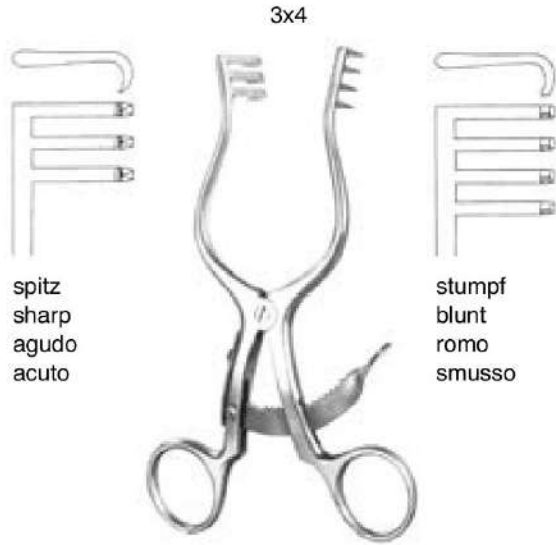
HOLZHEIMER  
 EV19634-10 EV19635-10  
 10 cm, 4"



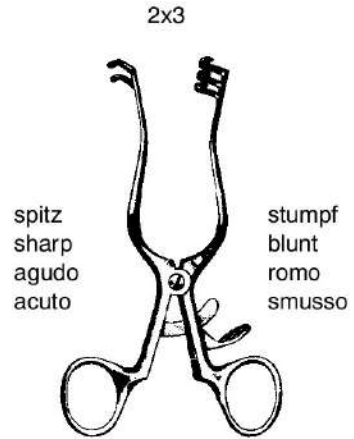
PERKINS  
 EV19636-14  
 13 cm, 5 1/8"



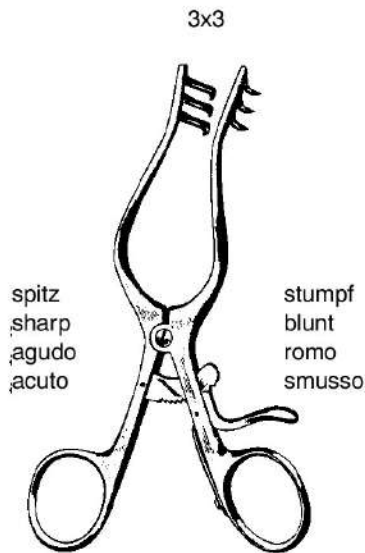
PERKINS  
 EV19637-14  
 13 cm, 5 1/8"



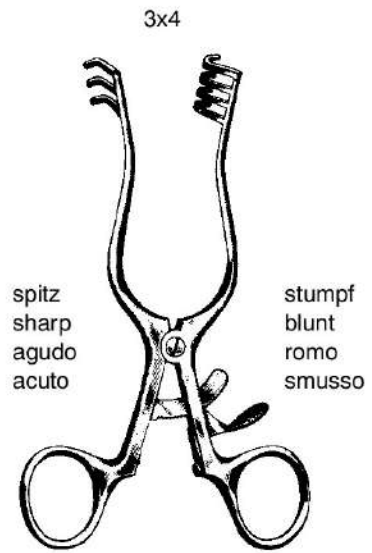
SCALP-CONTOUR  
EV19640-14 - EV19641-14  
13,5 cm, 5 1/4"



WEITLANER EV19650-10  
EV19651-10 11,5 cm, 4 1/2"

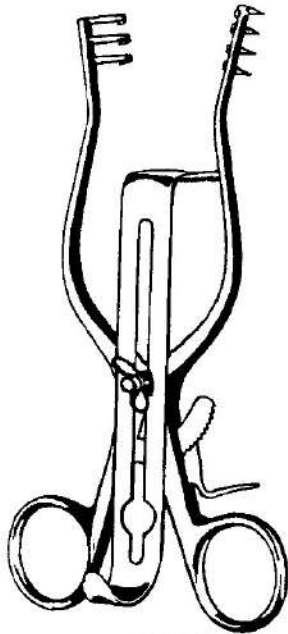


WEITLANER-WULLSTEIN  
EV19654-13 EV19655-13  
13 cm, 5 1/8"

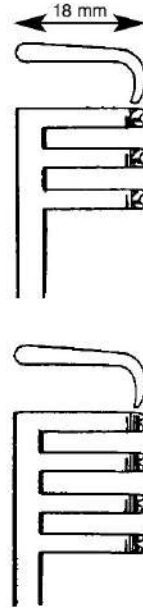


WEITLANER

|            |                 |            |
|------------|-----------------|------------|
| EV19670-14 | 14,0 cm, 5 1/2" | EV19671-14 |
| EV19670-16 | 16,5 cm, 6 1/2" | EV19671-16 |
| EV19670-20 | 20,0 cm, 8"     | EV19671-20 |
| EV19670-24 | 24,0 cm, 9 1/2" | EV19671-24 |



**HENLEY**  
EV19675-00 - EV19677-32  
16,5 cm, 6 1/2"

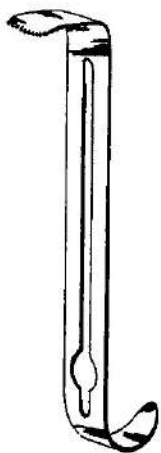


EV19675-00 komplett, stumpf, 3x4 Z. und 3 Valven  
EV19675-00 complete, blunt, 3x4 teeth and 3 blades  
EV19675-00 completo, romo, 3x4 dientes y 3 valvas  
EV19675-00 completo, smusso, 3x4 d. e 3 valve

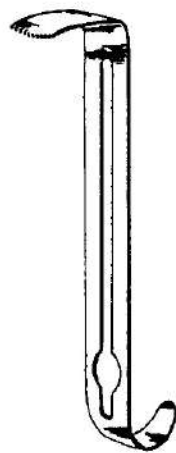
EV19676-00 komplett, scharf, 3x4 Z. und 3 Valven  
EV19676-00 complete, sharp, 3x4 teeth and 3 blades  
EV19676-00 complete, agudo, 3x4 dientes y 3 valvas  
EV19676-00 completo con retr. acuto 3x4 d. e 3 valve

EV19678-05 Retraktor allein, stumpf 3x4 Zähne  
EV19678-05 Retractor only, blunt 3x4 teeth  
EV19678-05 Separador solo, romo, 3x4 dientes  
EV19678-05 Retrattore solo, smusso 3x4 denti

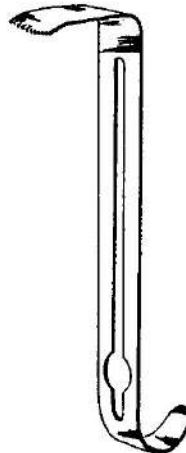
EV19678-06 Retraktor allein, spitz 3x4 Zähne  
EV19678-06 Retractor only, sharp 3x4 teeth  
EV19678-06 Separador solo, agudo, 3x4 dientes  
EV19678-06 Retrattore solo, acuto 3x4 denti



EV19677-19  
16x19 mm  
5/8" x 3/4"



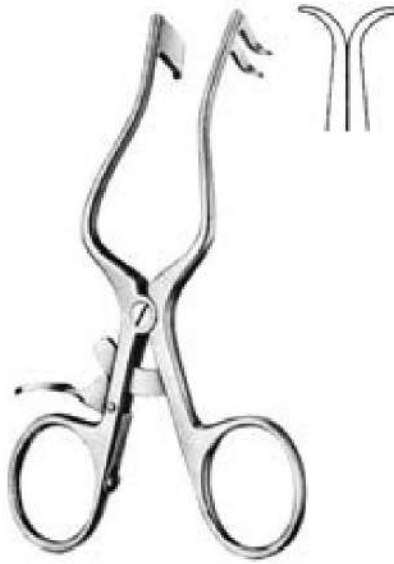
EV19677-25  
16x25 mm  
5/8" x 1"



EV19677-32  
16x32 mm  
5/8" x 1 1/4"



**PLESTER**  
EV19672-11 11 cm, 4 3/8" stumpf  
- blunt - romo - smusso



**PLESTER**  
EV19673-11 11 cm, 4 3/8" stumpf -  
blunt - romo - smusso



**MOLLISON**  
EV19674-15 15 cm, 6"  
scharf - sharp - agudo - acuto



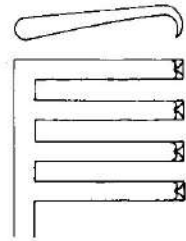
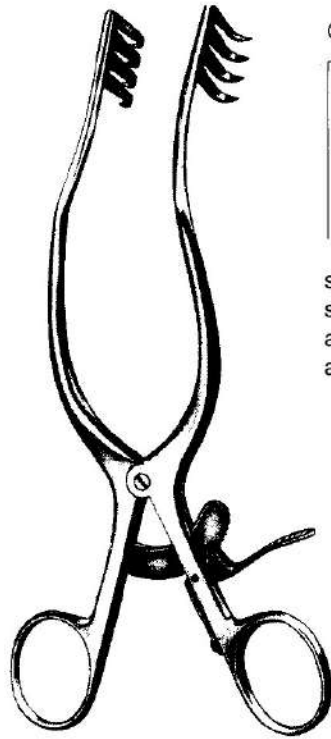
**WULLSTEIN**  
EV19675-13 13 cm, 5 1/8" stumpf  
- blunt - romo - smusso



**PLESTER**  
EV19677-13 13 cm, 5 1/8"  
scharf - sharp - agudo - acuto



**MAYO-ADAMS**  
EV19678-16 16,5 cm, 6 1/2"  
stumpf - blunt - romo - smusso



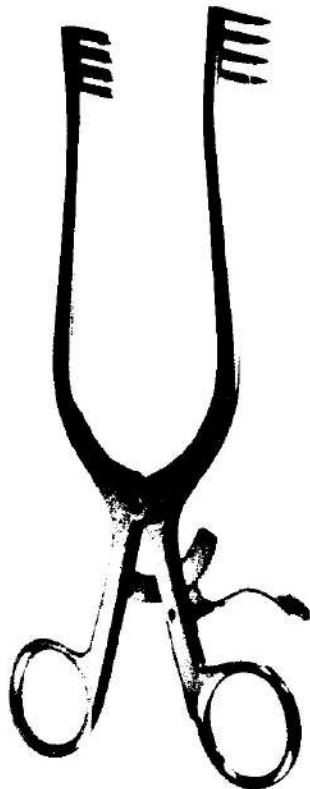
spitz  
sharp  
agudo  
acuto

ANDERSON ADSON  
EV19679-20 19,5 cm, 7 3/4"



stumpf  
blunt  
romo  
smusso

NORFOLK / NORWICH  
EV19679-22 22 cm, 8 3/4"



stumpf  
blunt  
romo  
smusso

spitz  
sharp  
agudo  
acuto

ADSON  
EV19680-19 19 cm, 7 1/2" EV19681-19

stumpf  
blunt  
romo  
smusso

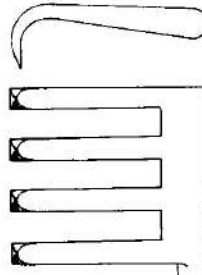


stumpf  
blunt  
romo  
smusso

TRAVERS  
EV19681-21 21,5 cm, 8 1/2"

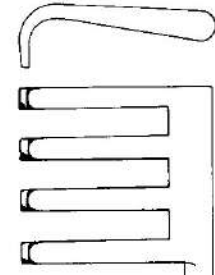


spitz  
sharp  
agudo  
acuto



EV19682-26

stumpf  
blunt  
romo  
smusso

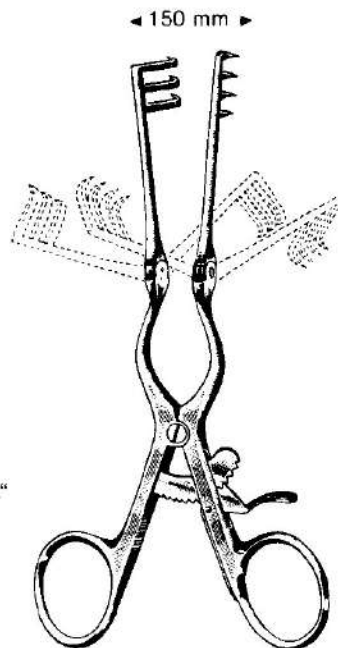


EV19683-26

ADSON  
EV19682-26 - EV19683-26  
26,5 cm, 10 1/2"

- EV19684-14 14 cm, 5 1/2"
- EV19684-16 16 cm, 6 1/4"
- EV19684-20 20 cm, 8"
- EV19684-26 26 cm, 10 1/4"

spitz  
sharp  
agudo  
acuto



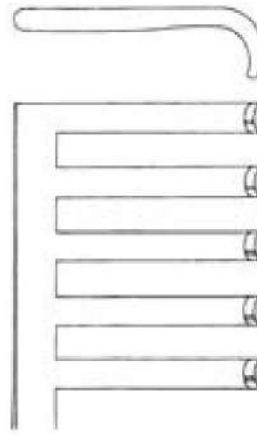
ADSON

- EV19685-14 14 cm, 5 1/2"
- EV19685-16 16 cm, 6 1/4"
- EV19685-20 20 cm, 8"
- EV19685-26 26 cm, 10 1/4"

stumpf  
blunt  
romo  
smusso



Wundsperrer  
Retractors  
Separadores  
Divaricatori

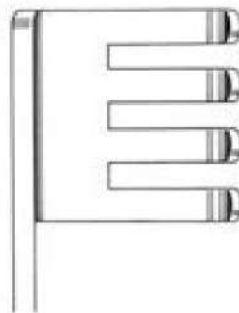


stumpf  
blunt  
romo  
smusso

ADSON  
EV19686-32  
32 cm, 12 3/4"

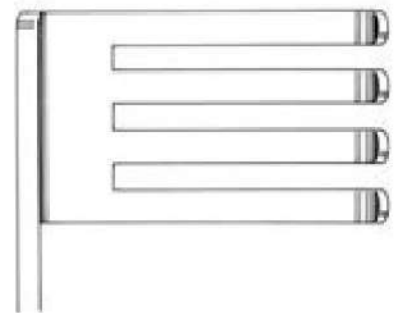


BECKMAN-ADSON  
31 cm, 12 1/4"



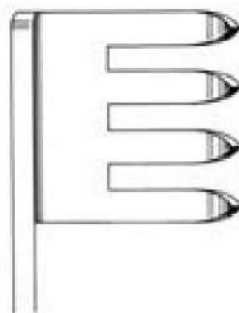
EV19687-01  
25 x 31 mm

stumpf  
blunt  
romo  
smusso



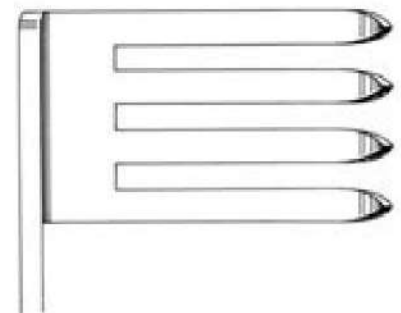
EV19688-01  
45 x 27 mm

stumpf  
blunt  
romo  
smusso



EV19687-02  
25 x 31 mm

scharf  
sharp  
agudo  
acuto



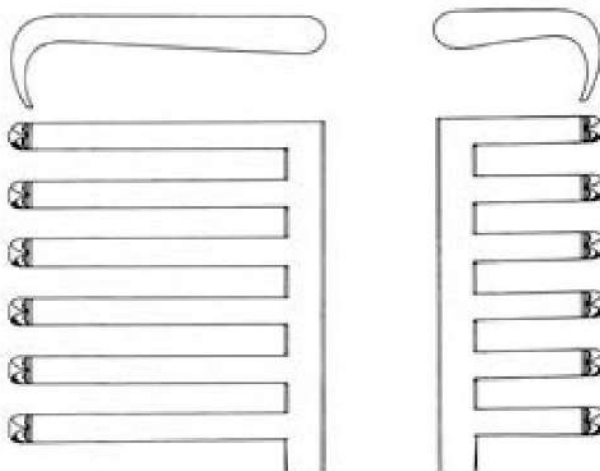
EV19688-02  
45 x 27 mm

scharf  
sharp  
agudo  
acuto

Wundsperrer  
Retractors  
Separadores  
Divaricatori

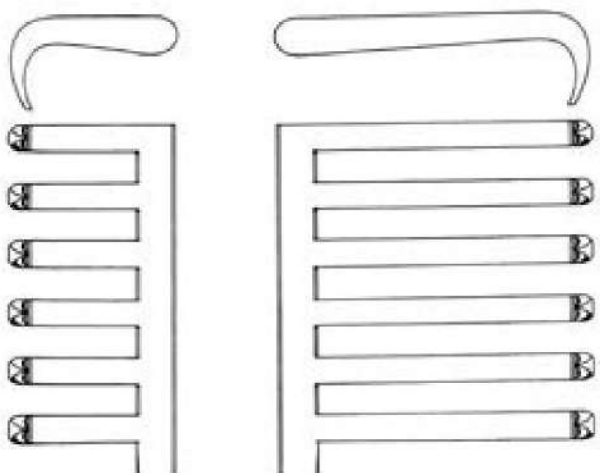


MARTIN  
28,5 cm, 11 1/4"



EV19689-01  
6x6 Zähne

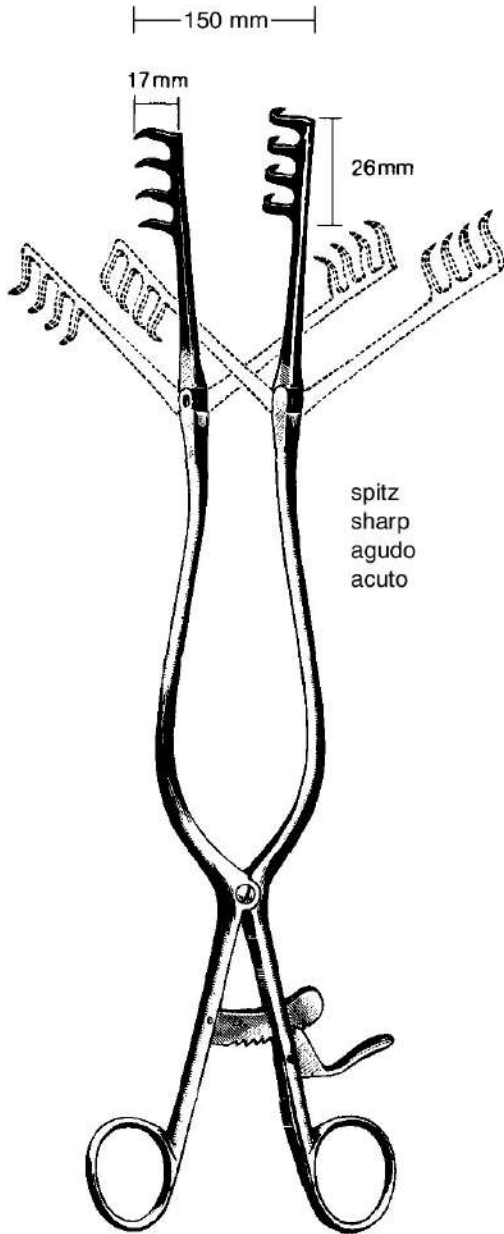
scharf, lange Zähne links  
sharp, long teeth on left side  
agudo, dientes largos a la izquierda  
acuto, denti lunghe a sinistra



EV19689-02  
6x6 Zähne

scharf, lange Zähne rechts  
sharp, long teeth on right side  
agudo, dientes largos a la derecha  
acuto, denti lunghe a destra

Wundsperrer  
Retractors  
Separadores  
Divaricatori



spitz  
sharp  
agudo  
acuto

BECKMANN  
EV19690-31  
31 cm, 12 1/4"



spitz  
sharp  
agudo  
acuto

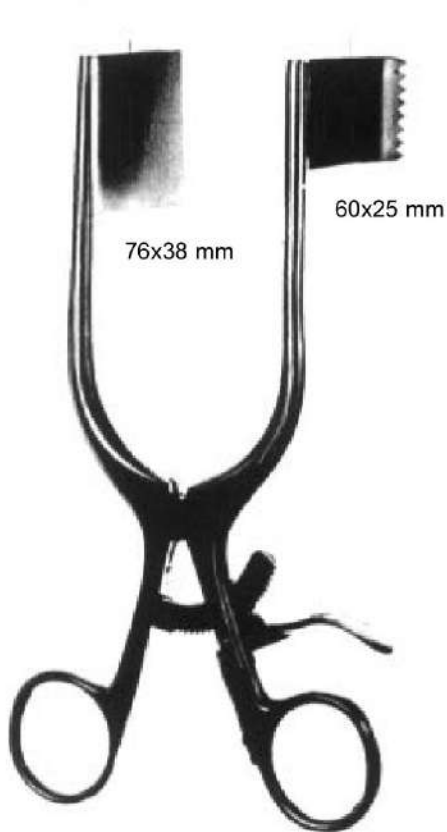
BECKMANN-EATON  
EV19692-32  
32 cm, 12 3/4"



- |            |               |            |
|------------|---------------|------------|
| EV19694-01 | 20 cm, 8"     | 50 x 16 mm |
| EV19694-02 | 23 cm, 9"     | 75 x 25 mm |
| EV19694-03 | 24 cm, 9 1/2" | 90 x 50 mm |

MEYERDING

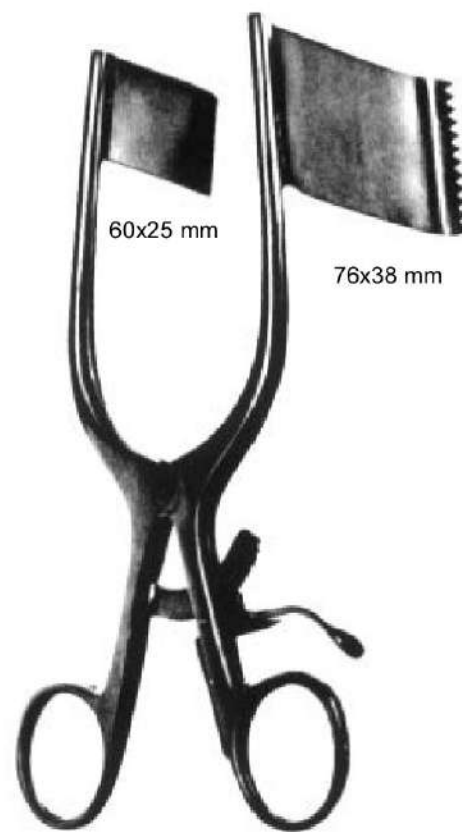
Hemilaminectomiespreizer  
Hemilaminectomy Retractor  
Separadores para hemilaminectomía  
Divaricatori per emilaminectomia



DARLING

EV19696-18 18 cm, 7"

links  
left  
a la izquierda a sinistra



DARLING

EV19698-18 18 cm, 7"

rechts right  
a la derecha a  
destra

Cervicalspreizer  
 Cervical Retractor  
 Separador cervical  
 Divaricatore cervicale



CLOWARD  
 25 cm, 10"

spitz  
 sharp  
 agudo  
 acuto



|            |                 |
|------------|-----------------|
| EV19710-40 | 40 x 15 / 23 mm |
| EV19710-45 | 45 x 15 / 23 mm |
| EV19710-50 | 50 x 15 / 23 mm |
| EV19710-55 | 55 x 15 / 23 mm |
| EV19710-60 | 60 x 15 / 23 mm |

EV19710-01  
 Sperrer, alleine  
 Retractor, only  
 Retractor, suelto  
 Divaricatore solo

EV19710-00  
 Sperrer komplett mit 5 Valven spitz  
 Retractor complete with 5 blades sharp  
 Separador completo con 5 valvas agudas  
 Divaricatore completo con 5 valve acute

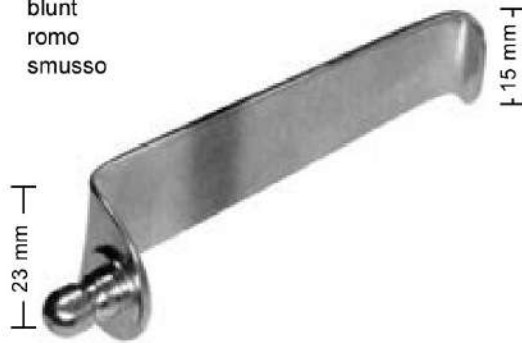


Cervicalspreizer  
 Cervical Retractor  
 Separador cervical  
 Divaricatore cervicale



CLOWARD  
 25 cm, 10"

stumpf  
 blunt  
 romo  
 smusso



|            |                 |
|------------|-----------------|
| EV19711-40 | 40 x 15 / 23 mm |
| EV19711-45 | 45 x 15 / 23 mm |
| EV19711-50 | 50 x 15 / 23 mm |
| EV19711-55 | 55 x 15 / 23 mm |
| EV19711-60 | 60 x 15 / 23 mm |

EV19710-01 Sperrer,  
 alleine Retractor, only  
 Retractor, suelto Divari-  
 catore solo

EV19712-00  
 Sperrer komplett mit 5 Valven stumpf  
 Retractor complete with 5 blades blunt  
 Separador completo con 5 valvas romas  
 Divaricatore completo con 5 valve smusse



Cervicalspreizer  
 Cervical Retractor  
 Separador cervical  
 Divaricatore cervicale

spitz  
 sharp  
 agudo  
 acuto



|            |                 |
|------------|-----------------|
| EV19710-40 | 40 x 15 / 23 mm |
| EV19710-45 | 45 x 15 / 23 mm |
| EV19710-50 | 50 x 15 / 23 mm |
| EV19710-55 | 55 x 15 / 23 mm |
| EV19710-60 | 60 x 15 / 23 mm |



CLOWARD  
 16 cm, 6 1/4"

EV19711-01  
 Sperrer, alleine  
 Retractor, only  
 Retractor, suelto  
 Divaricatore solo

EV19711-00  
 Sperrer komplett mit 5 Valven spitz  
 Retractor complete with 5 blades sharp  
 Separador completo con 5 valvas agudas  
 Divaricatore completo con 5 valve acute

Cervicalspreizer  
 Cervical Retractor  
 Separador cervical  
 Divaricatore cervicale



CLOWARD  
 16 cm, 6 1/4"

stumpf  
 blunt  
 romo  
 smusso



|            |                 |
|------------|-----------------|
| EV19711-40 | 40 x 15 / 23 mm |
| EV19711-45 | 45 x 15 / 23 mm |
| EV19711-50 | 50 x 15 / 23 mm |
| EV19711-55 | 55 x 15 / 23 mm |
| EV19711-60 | 60 x 15 / 23 mm |

EV19711-01 Sperrer,  
 alleine Retractor, only  
 Retractor, suelto Di-  
 varicatore solo

EV19713-00  
 Sperrer komplett mit 5 Valven stumpf  
 Retractor complete with 5 blades blunt  
 Separador completo con 5 valvas romas  
 Divaricatore completo con 5 valve smusse

Cervicalspreizer  
 Cervical Retractor  
 Separador cervical  
 Divaricatore cervicale

90 mm, 3 1/2"



CASPAR  
 EV19721-15  
 165 mm, 5 1/2"

Sperrer, alleine  
 Retractor, only  
 Retractor, suelto  
 Divaricatore solo



EV19726-01

Blätter-Wechselpinzette  
 Blade ejector  
 Pinza para cambiar hojas  
 Pinze per cambiare valve

EV19721-00  
 Sperrer komplett mit 5 Valven stumpf  
 Retractor complete with 5 blades blunt  
 Separador completo con 5 valvas romas  
 Divaricatore completo con 5 valve smusse

- EV19738-45 45 x 23 mm
- EV19738-50 50 x 23 mm
- EV19738-55 55 x 23 mm
- EV19738-60 60 x 23 mm
- EV19738-65 65 x 23 mm

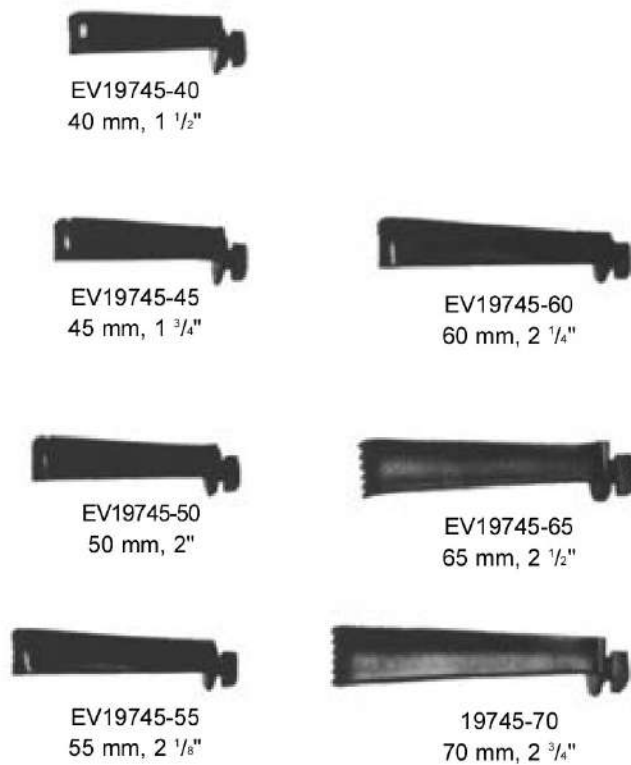


Lumbal-Wundspreizer  
 Lumbal Retractors  
 Separadores lumbales autoestáticos  
 Divaricatori autostatici lombari



CASPAR  
 EV19744-00  
 komplett mit 7 Blätter  
 compl. incl. 7 blades  
 completo con 7 valvas  
 complete di 7 valve

EV19744-17  
 ohne Blätter  
 without blades  
 sin valvas  
 senza valve



EV19745-40  
 40 mm, 1 1/2"

EV19745-45  
 45 mm, 1 3/4"

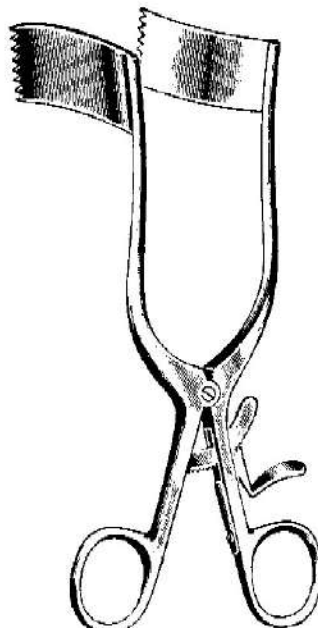
EV19745-50  
 50 mm, 2"

EV19745-55  
 55 mm, 2 1/8"

EV19745-60  
 60 mm, 2 1/4"

EV19745-65  
 65 mm, 2 1/2"

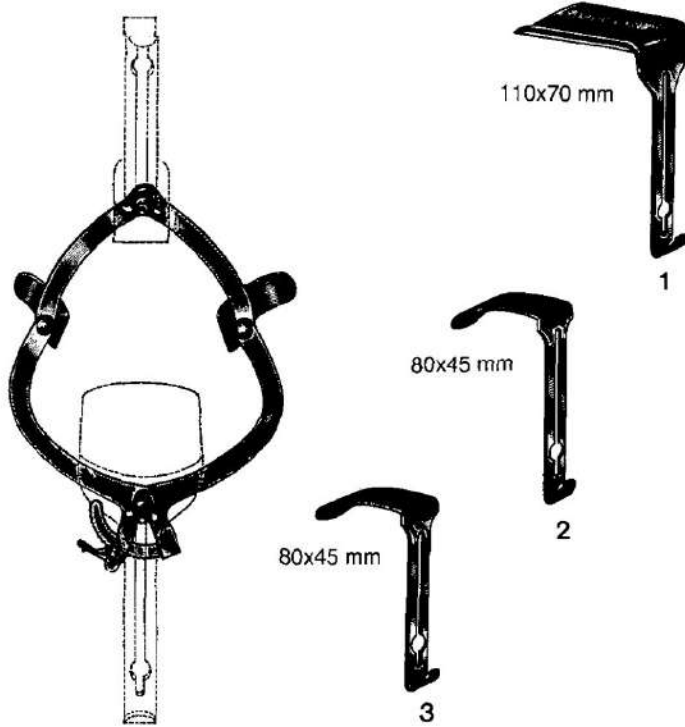
19745-70  
 70 mm, 2 3/4"



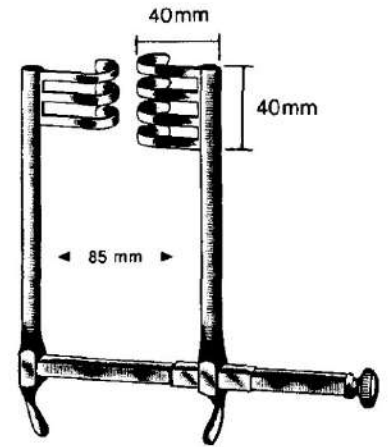
MEYERDING  
 17 cm, 6 3/4"

EV19748-01 2,5 x 3,2 cm  
 EV19748-02 2,5 x 5,4 cm  
 EV19748-03 1,9 x 6,0 cm  
 EV19748-04 2,5 x 6,0 cm

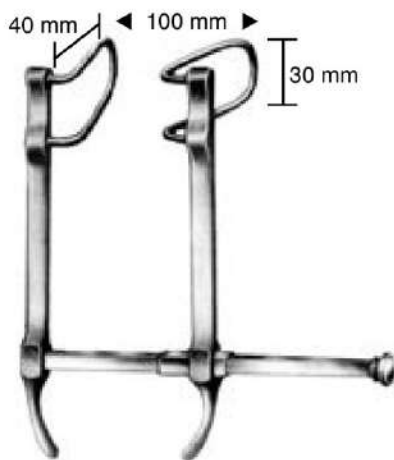
Bauchdeckenhalter  
Abdominal Retractors  
Separadores abdominales  
Divaricatori addominali



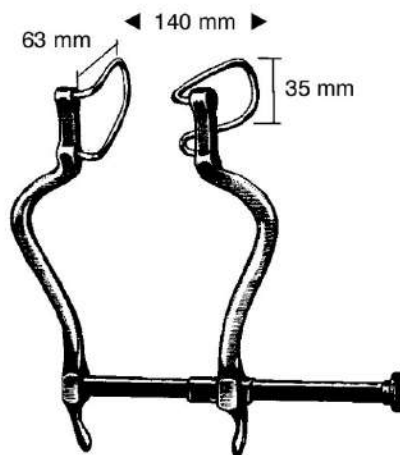
O'SULLIVAN - O'CONNOR  
EV19754-00  
compl.



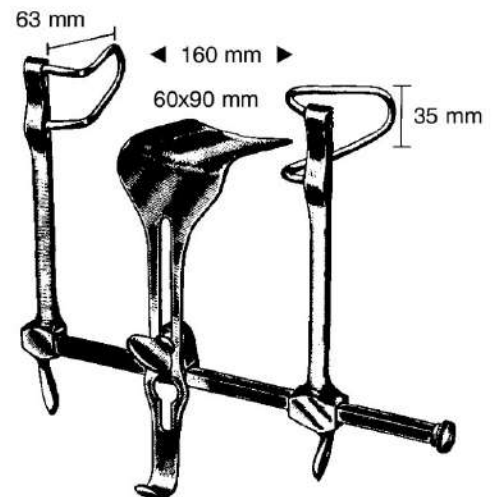
FRAZIER  
EV19758-85



BABY GOSSET  
EV19759-00

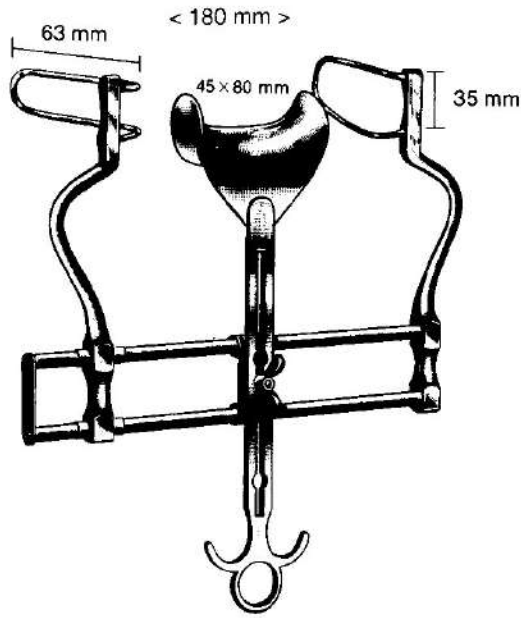


GOSSET  
EV19760-14

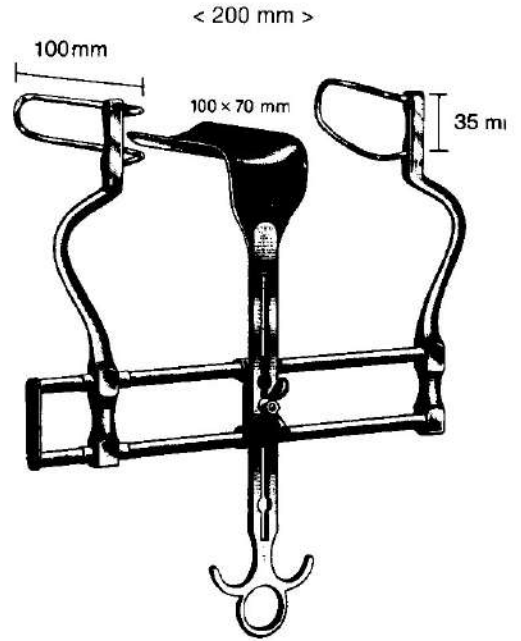


GOSSET  
EV19762-16

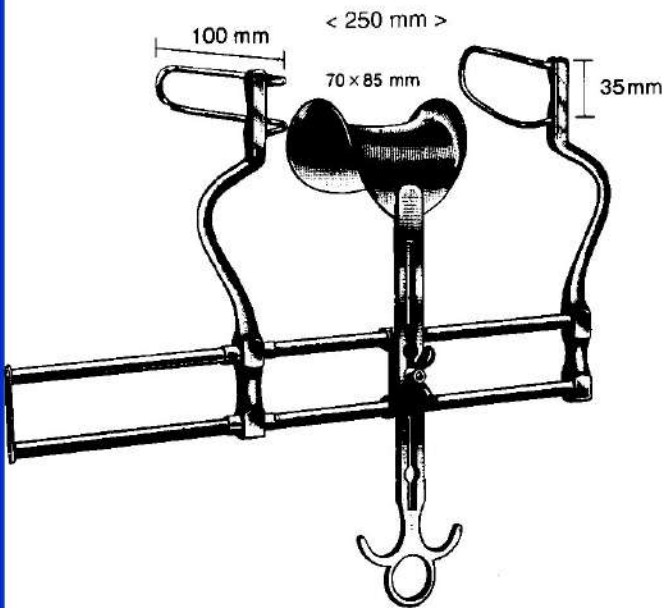
Bauchdeckenhalter  
 Abdominal Retractors  
 Separadores abdominales  
 Divaricatori addominali



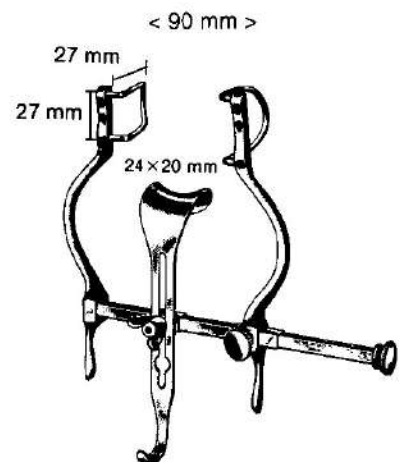
BALFOUR  
 EV19764-18  
 18 cm, 7"



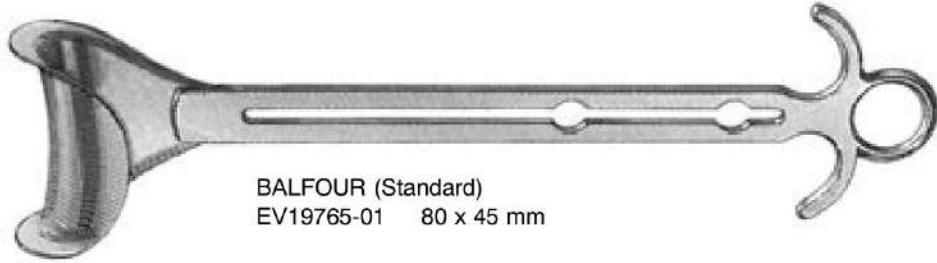
BALFOUR  
 EV19764-20  
 20 cm, 8"



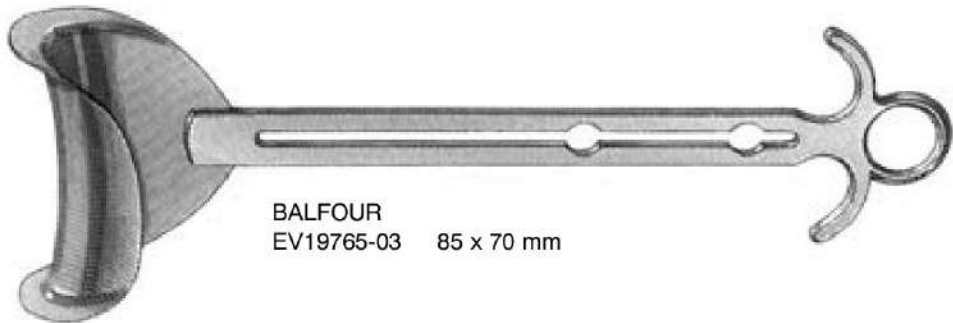
BALFOUR  
 EV19764-25  
 25 cm, 10"



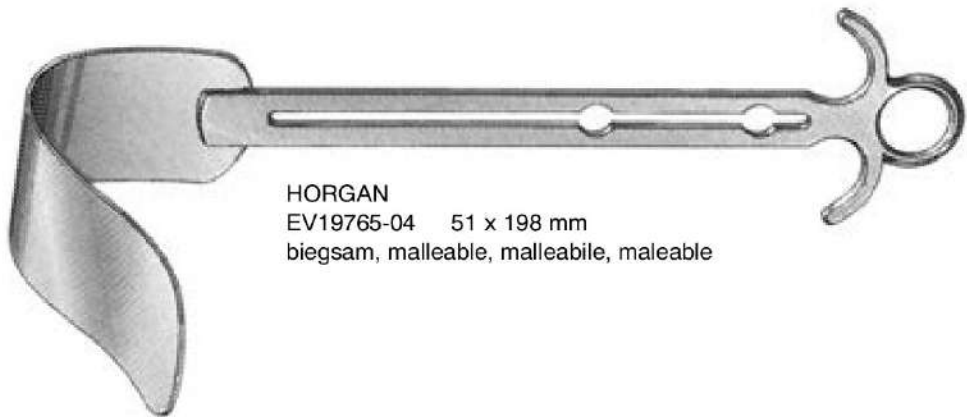
BALFOUR Baby  
 EV19766-90  
 9 cm, 3 1/2"



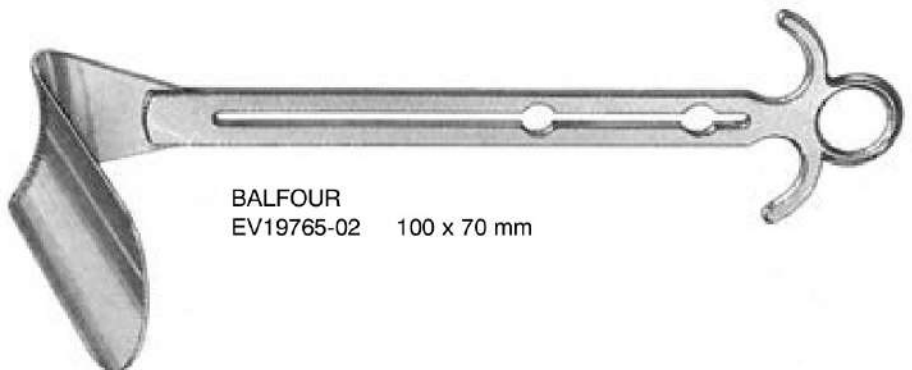
BALFOUR (Standard)  
EV19765-01 80 x 45 mm



BALFOUR  
EV19765-03 85 x 70 mm



HORGAN  
EV19765-04 51 x 198 mm  
biegsam, malleable, malleabile, maleable



BALFOUR  
EV19765-02 100 x 70 mm

Bauchdeckenhalter  
Abdominal Retractors  
Separadores abdominales  
Divaricatori addominali



EV19767-01  
Drahtvalven 5 cm (1.96") tief (Paar) Fenestrated blades 5 cm (1.96") deep (pair) Valvas de alambre 5 cm (1.96") profundidad (par) Valve di filo profondità 5 cm (1.96") (paio)



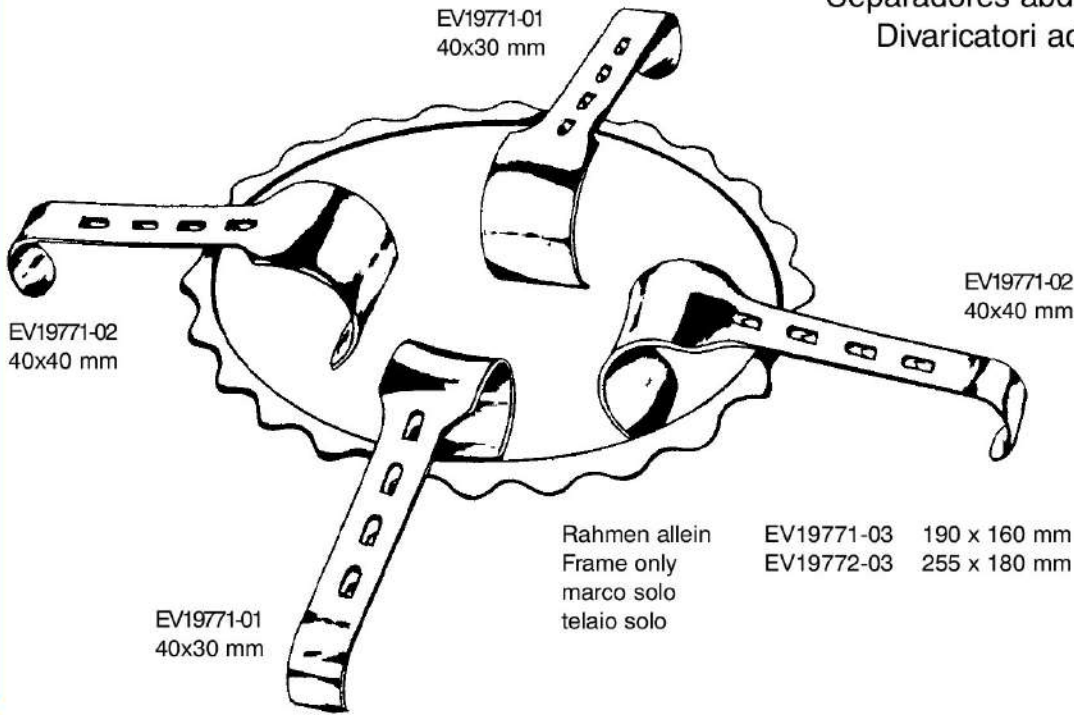
EV19767-02  
Drahtvalven 7,5 cm (2,95") tief (Paar) Fenestrated blades 7,5 cm (2,95") deep (pair) Valvas de alambre 7,5 cm 2,95" profundidad (par) Valve di filo profondità 7,5 cm (2,95") (paio)



BALFOUR-US  
EV19767-18  
EV19767-25  
komplett  
complete  
completo

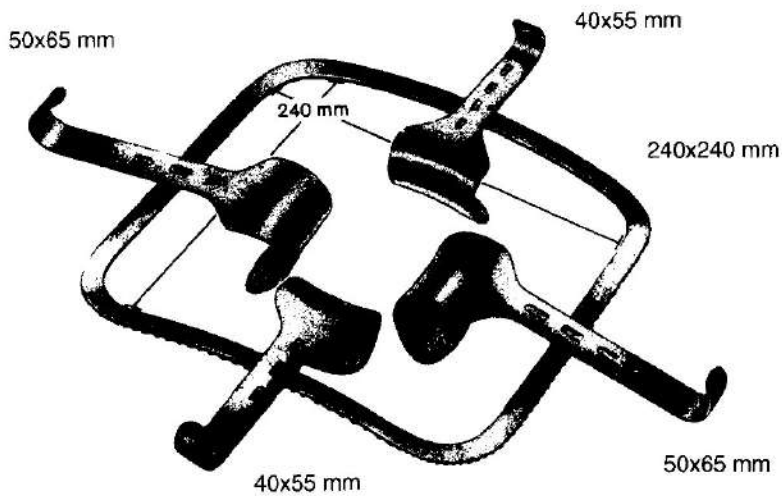


Bauchdeckenhalter  
Abdominal Retractors  
Separadores abdominales  
Divaricatori addominali



DENIS-BROWNE

EV19771-00 compl. Pediatric/pediatrico 190 x 160 mm  
EV19772-00 compl. Adult/adulto 255 x 180 mm



KIRSCHNER

EV19782-00

Kirschner Bauchdeckenhalter komplett bestehend aus:  
Kirschner Abdominal Retr. complete consisting of: Kirschner  
separador abdominal completo compuesto de: Kirschner  
Divaricatore addominale completo, composto da:



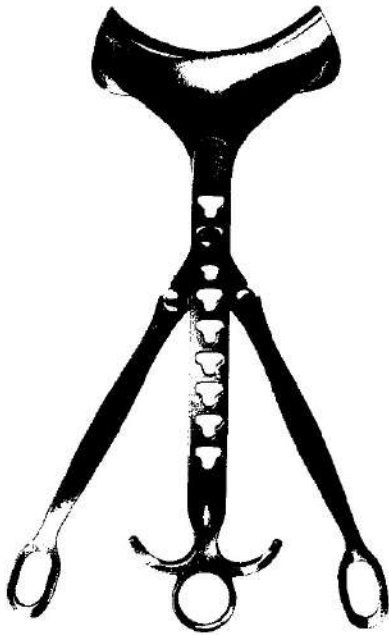
EV19781-55  
40 x 55 mm breit



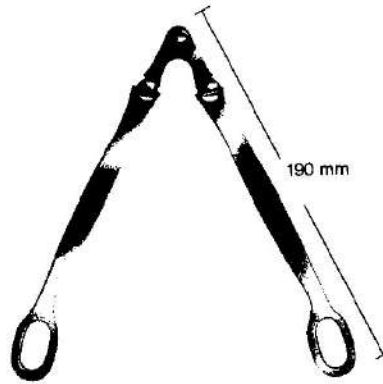
EV19781-65  
50 x 65 mm breit

- EV19781-55 2 Rahmenhaken / 2 Hook-on Retr. / 2 separadores / 2 divaricatori 40 x 55 mm
- EV19781-65 2 Rahmenhaken / 2 Hook-on Retr. / 2 separadores / 2 divaricatori 50 x 65 mm
- EV19783-24 Rahmen fest / frame rigid / marco rigido / telaio rigido 240 x 240 mm

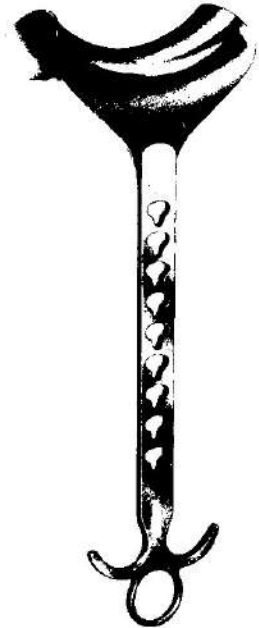
Bauchdeckenhalter  
 Abdominal Retractors  
 Separadores abdominales  
 Divaricatori addominali



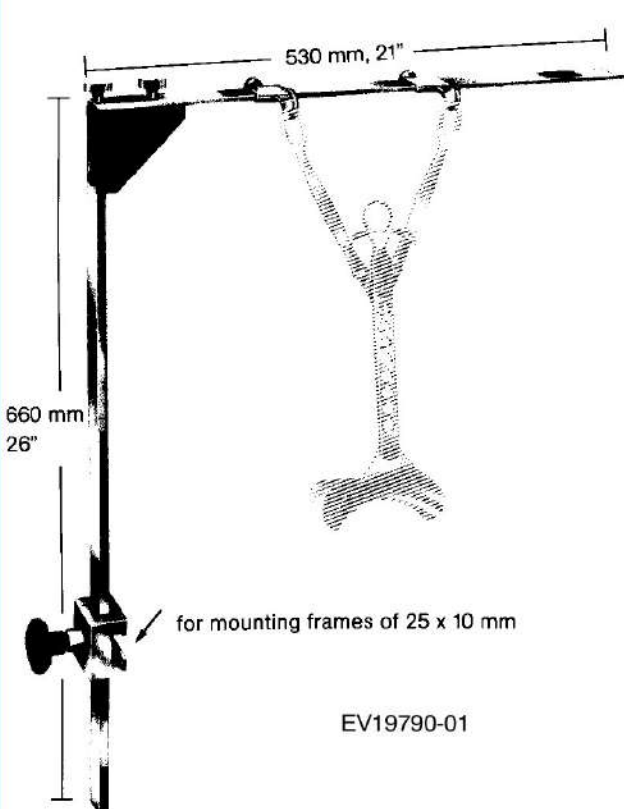
EV19780-01 + EV19770-01



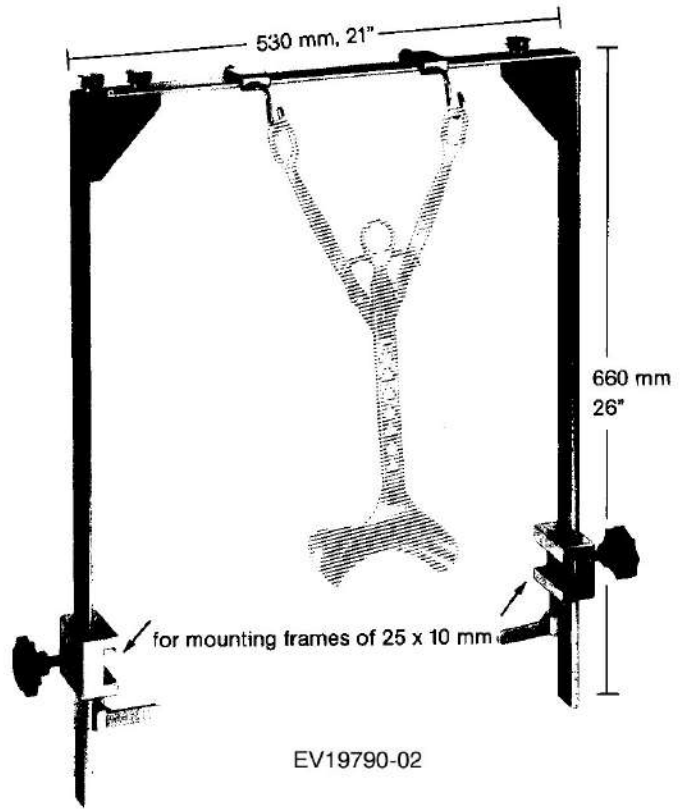
ROCHARD  
 EV19780-01



ROCHARD  
 31 cm, 12 1/4"  
 EV19770-01 48x 90 mm  
 EV19770-02 48x105 mm  
 EV19770-03 48x120 mm  
 EV19770-04 48x135 mm  
 EV19770-05 48x155 mm

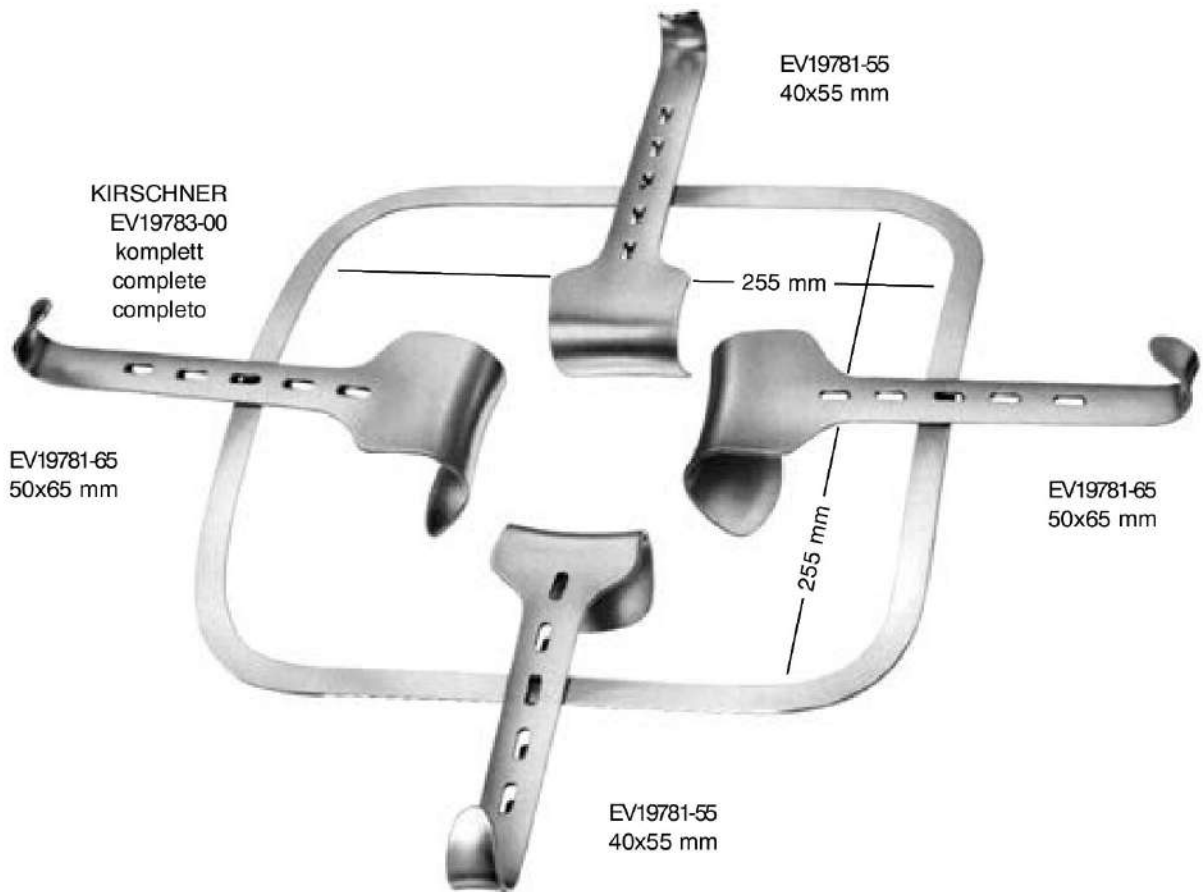


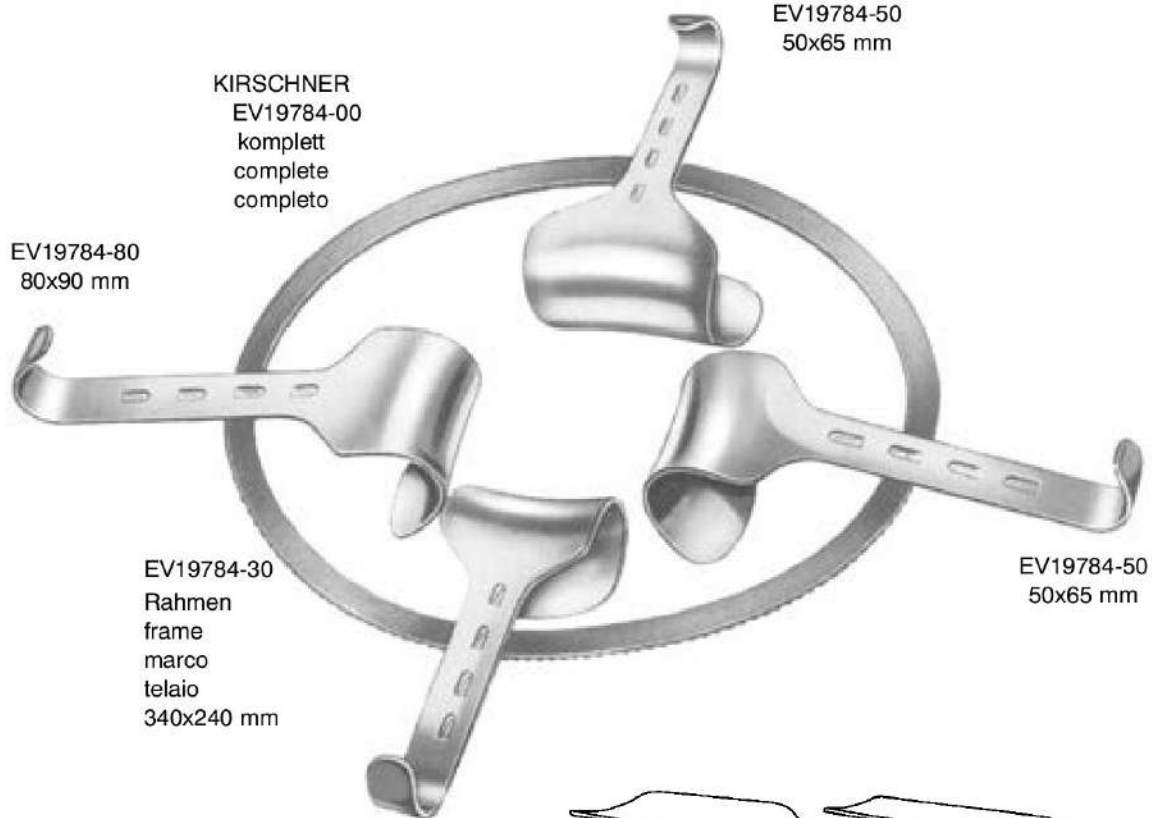
EV19790-01



EV19790-02

Bauchdeckenhalter  
Abdominal Retractors  
Separadores abdominales  
Divaricatori addominali





KIRSCHNER  
EV19784-00  
komplett  
complete  
completo

EV19784-50  
50x65 mm

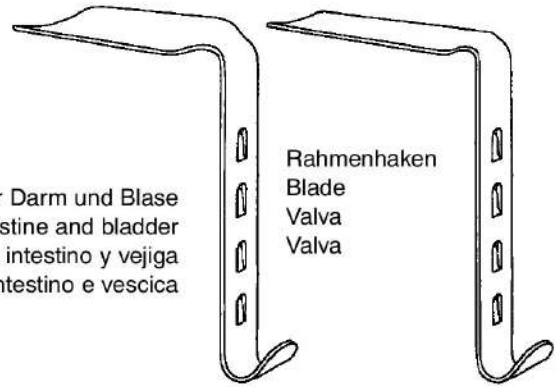
EV19784-80  
80x90 mm

EV19784-30  
Rahmen  
frame  
marco  
telaio  
340x240 mm

EV19784-50  
50x65 mm

EV19784-50  
50x65 mm

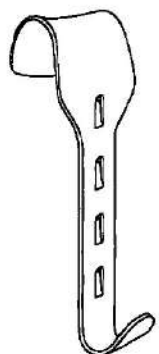
für Darm und Blase  
for intestine and bladder  
para intestino y vejiga  
per intestino e vescica



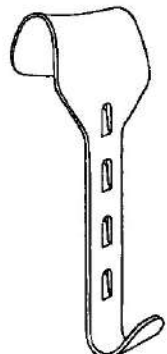
Rahmenhaken  
Blade  
Valva  
Valva

EV19784-98  
98x50 mm

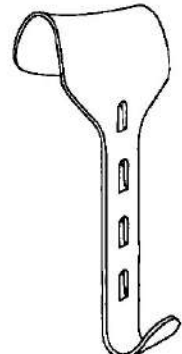
EV19784-99  
105x35 mm



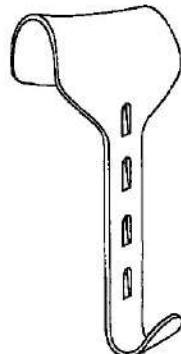
EV19784-40  
40x55 mm



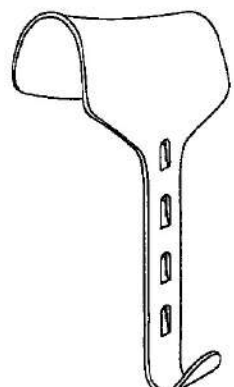
EV19784-50  
50x65 mm



EV19784-60  
60x85 mm



EV19784-78  
78x65 mm



EV19784-80  
80x90 mm

Arm System  
 Arm System  
 Sistema de brazo  
 Sistema braccio



**EV19795-01**  
 Armsystem Radius 310/420 mm komplett mit Wundhakenhalter und U-Stativ Ø 16 mm, 400 mm hoch, 400 mm breit, 170 mm tief (ohne Klemmsocket).  
 Arm System, radius 310/420 mm, including retractor and U-stand Ø 16 mm, 400 mm high, 400 mm wide, 170 mm deep (without clamp socket).

**EV19795-02**  
 Armsystem Radius 310/420 mm komplett mit Stativ, Klemmsocket und Endoskophalter Ø 8/10 mm.  
 Arm System, radius 310/420 mm, including stand, clamp, endoscope holder Ø 8/10 mm.



**EV19798-01** Zweischauchhalterung aus Aluminium  
 Double tube holder made of aluminium

**EV19798-02** Endoskophalterung Universal Ø 3-10 mm  
 Endoscope holder Universal Ø 3-10 mm

**EV19798-03** Universelle Wundhakenhalterung Universal  
 retractor holder

**EV19798-04** Gelenkverlängerung  
 180 mm lang mit Feststellung  
 Extended articulation  
 180 mm long, lockable



EV19799-03 Leichtmetall-Klemms-  
 sockel Spannbreite 35 mm, für ein  
 Schraubstativ mit  
 Ø 16 mm/M10, für Schienen  
 25/35 x 8/10 und Rohre Ø 12 - 35 mm.  
 Clamp socket made of light metal,  
 holding width 35 mm, for screw stand  
 Ø 16 mm/M10, for rails 25/35 x 8/10  
 and tubes Ø 12 - 35 mm.



EV19799-04 Leichtmetall-Klemm-  
 sockel Spannbreite 50 mm, für ein  
 höhenverstellbares Stativ Ø 16 mm,  
 für Schienen  
 25/35 x 8/10 und Rohre Ø 12 - 35 mm.  
 Clamp socket made of light metal,  
 holding width 50 mm, for height-  
 adjustable stand Ø 16 mm, for rails  
 25/35 x 8/10 and tubes Ø 12 - 35 mm.



EV19799-05  
 Klemms-  
 sockel aus rostfreiem Stahl, für  
 ein höhenverstellbares Stativ Ø 16 mm,  
 elektrisch isoliert bis 4,5 kV AC,  
 Spannbreite 50 mm für Schienen 25/32  
 x 8/12 mm.  
 Clamp socket made of stainless steel,  
 for height-adjustable stand Ø 16 mm,  
 electrically insulated up to 4.5 kV AC,  
 holding width of 50 mm for rails  
 25/32 x 8/12 mm.

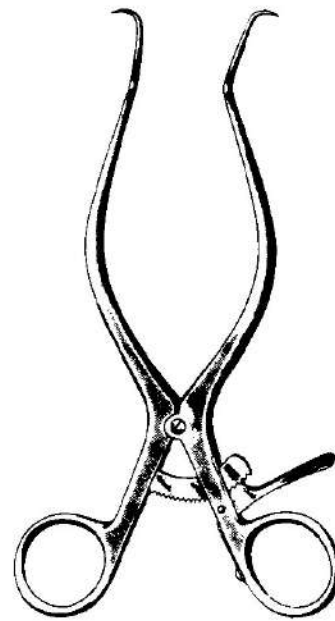


EV19799-06 Leichtmetall-Klemm-  
 sockel Spannbreite 50 mm, für ein  
 Schraubstativ mit  
 Ø 16 mm/M10, für Schienen  
 25/35 x 8/10 und Rohre Ø 12 - 35 mm.  
 Clamp socket made of light metal,  
 holding width 50 mm, for screw stand  
 Ø 16 mm/M10, for rails 25/35 x 8/10  
 and tubes Ø 12 - 35 mm.

Bauchdeckenhalter, Wundsperrer  
 Abdominal Retractors, Retractors  
 Separadores abdominales, Separadores  
 Divaricatori addominali, Divaricatori



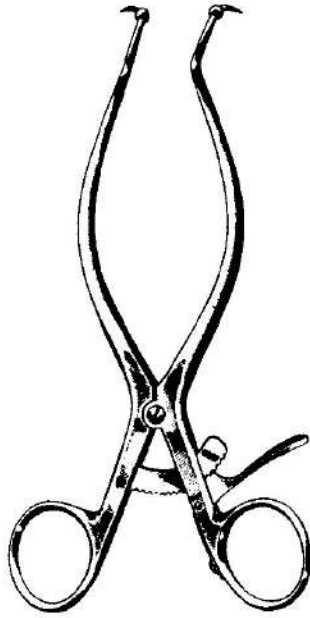
**DOYEN**  
 28 cm, 11"  
 EV19800-01 48x 90 mm  
 EV19800-02 48x105 mm  
 EV19800-03 48x120 mm  
 EV19800-04 48x135 mm



**GELPI**  
 EV19802-09 9 cm, 3 1/2"  
 EV19802-11 11 cm, 4 3/8"  
 EV19802-14 14 cm, 5 1/2"  
 EV19802-16 16 cm, 6 1/4"  
 EV19802-18 18 cm, 7"



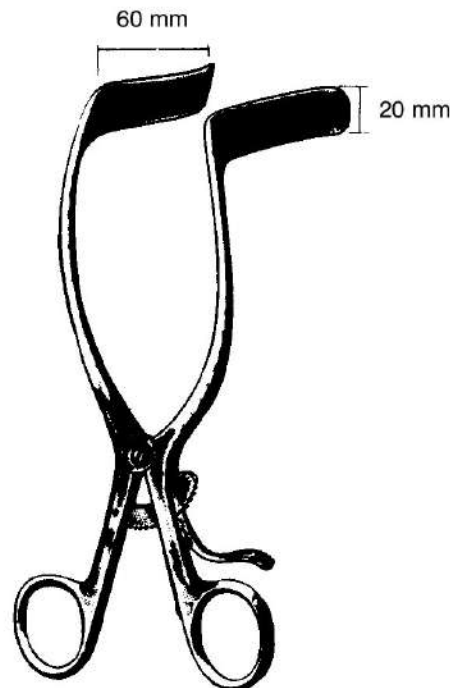
**DE BAKEY**  
 EV19803-14  
 14,5 cm, 5 3/4"



GELPI  
EV19804-18  
18 cm, 7"



JACKSON BURROWS  
EV19805-18  
18,5 cm, 7 1/4"



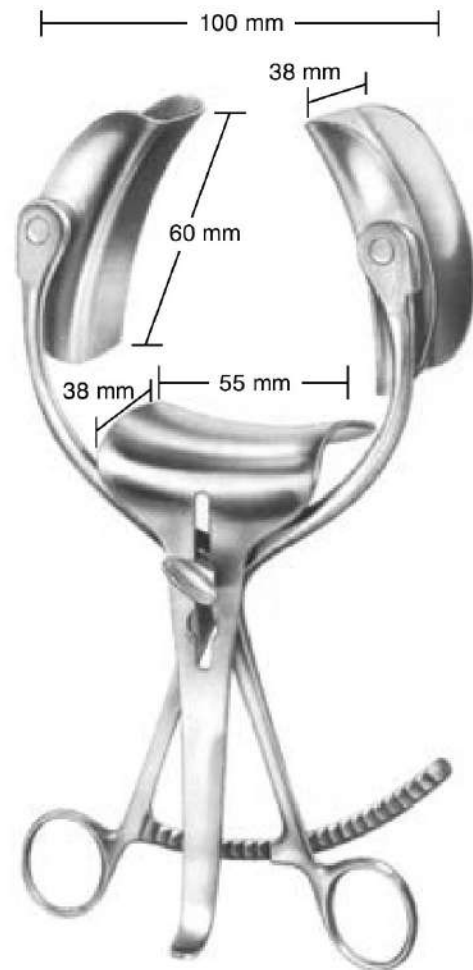
RIGBY  
EV19806-18  
18 cm, 7"



Bauchdeckenhalter  
Abdominal Retractors  
Separadores abdominales  
Divaricatori addominali

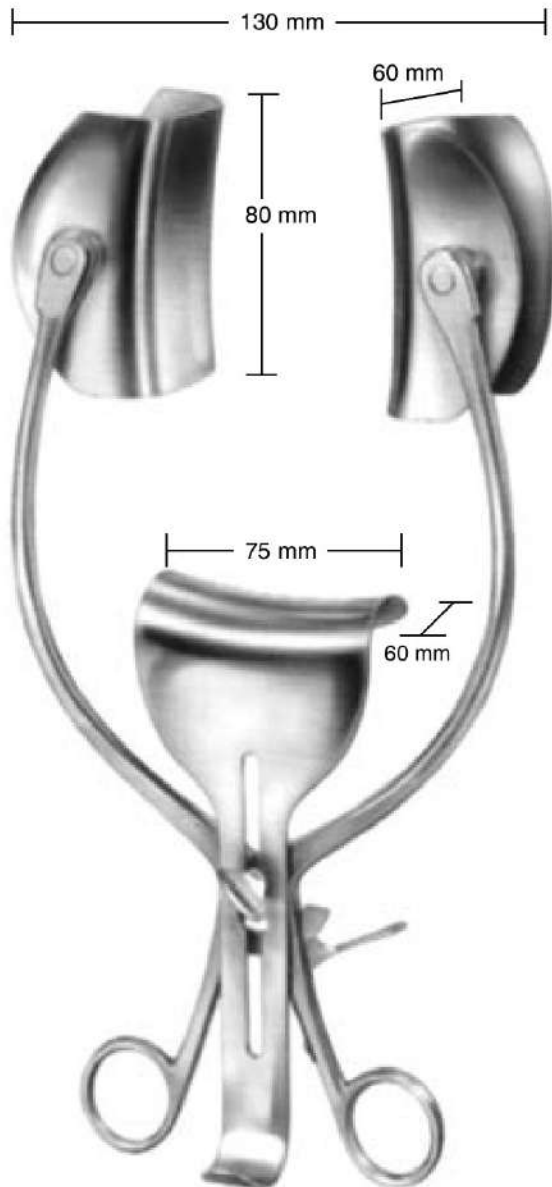


COLLIN  
EV19810-22  
komplett  
complete  
completo

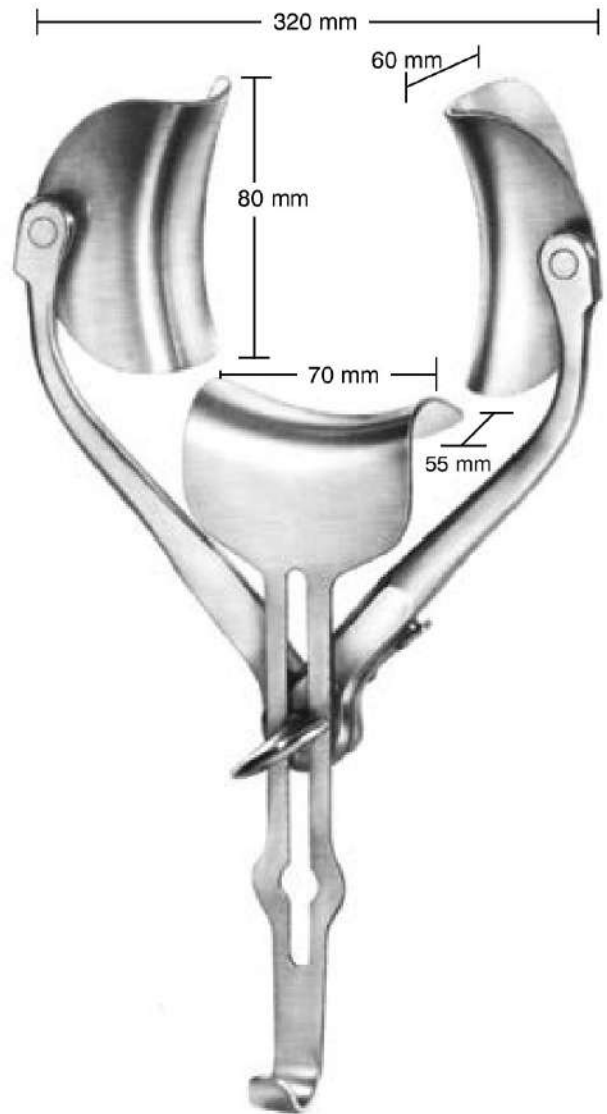


COLLIN  
EV19812-60  
komplett  
complete  
completo

Bauchdeckenhalter  
Abdominal Retractors  
Separadores abdominales  
Divaricatori addominali

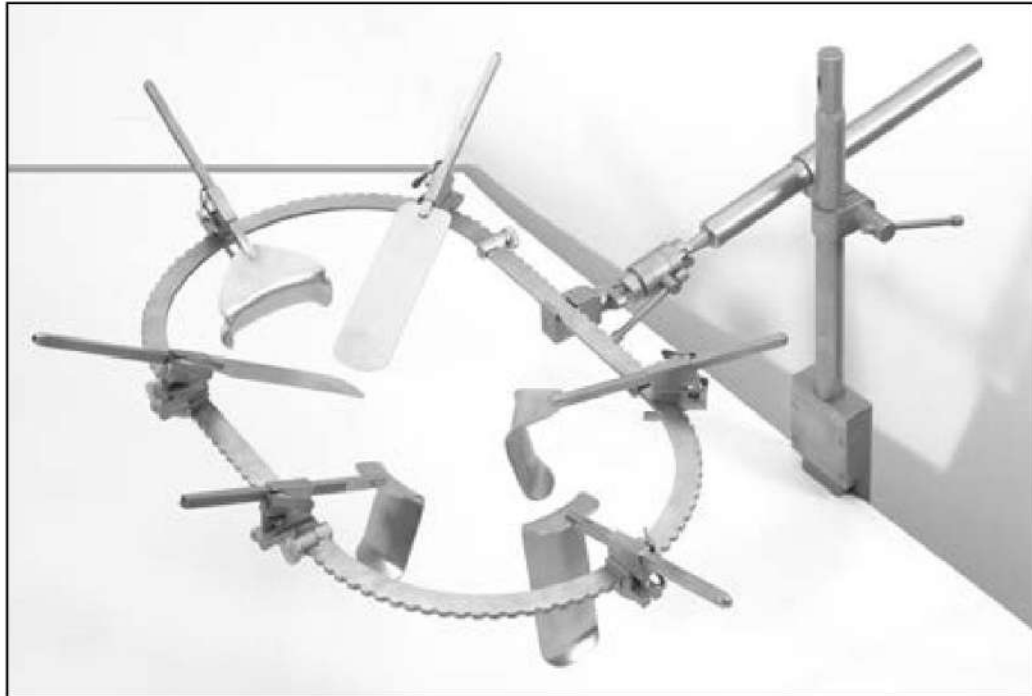


COLLIN Loktite  
EV19816-00 31 cm, 12 1/4"  
komplett / complete / completo

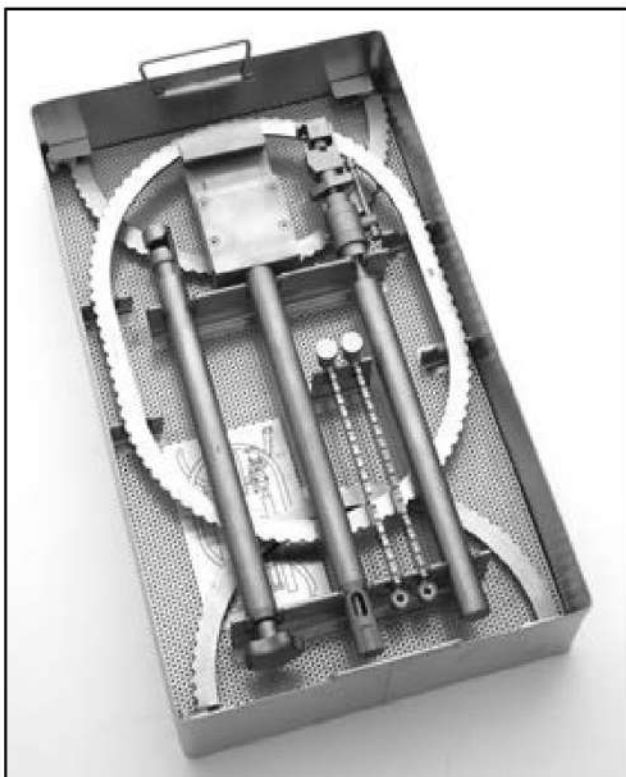


RICARD  
EV19813-00 30 cm, 11 3/4"  
komplett / complete / completo

Back holder Abdominal Retractor  
Operation Table Set



Complete Fixed Abdominal Retractor Set  
Set completo divaricatore addominale con sistema di montaggio modulare



The many components of the **Back holder Abdominal Retractor Operation Table Set** can all be neatly arranged into autoclave sized containers with diagrams that direct instrument handlers on proper placement of each component.

*A major convenience in care and maintenance of the Retractor Set*

**Sterilization Container & Baskets**

**Description**

**Product No**

Table Fixation & Ring Case

EV19820-90

Blade & Accessories Case

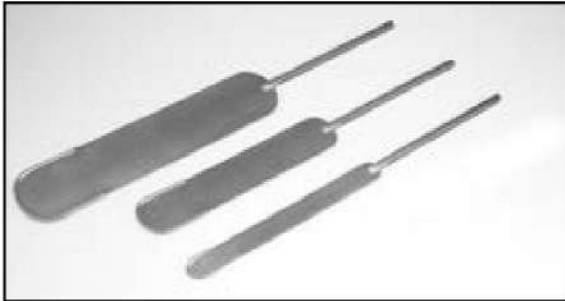
EV19820-91

**Back holder Abdominal Retractor  
Operation Table Set**

| <b>Description</b>                 | <b>Product No</b> | <b>Composto da</b>  |            |
|------------------------------------|-------------------|---|------------|
| Complete Abdominal Retractor Set   | 19820-99          | Accoppiatore  | EV19821-01 |
|                                    |                   | Barra orizzontale   | EV19821-02 |
| <i>Includes</i>                    |                   | Morsetto di accoppiamento   | EV19821-04 |
| Table Post                         | EV19821-01        | Anello ovale  | EV19820-02 |
| Horizontal Bar                     | EV19821-02        | No. 2 retrattori malleabili, 51x152 mm  | EV19825-06 |
| 1" Post Coupling                   | EV19821-04        | No. 2 Valve Kelly, dim. 51x76 mm  | EV19822-23 |
| Oval Ring                          | EV19820-02        | Valva Kelly   | EV19822-24 |
| 2" X 6" Malleable Retractor (2 ea) | EV19825-06        | Valva Balfour   | EV19823-33 |
| 2" X 3" Kelly Retractor (2 ea)     | EV19822-23        | Morsetto trasportabile con trasporto ad intervallo progressivo di 2 mm                          | EV19820-10 |
| 2" X 4" Kelly Retractor            | EV19822-24        | Morsetto articolato multidisciplinare con funzione movimento assiale orizzontale e verticale    | EV19820-20 |
| Balfour Retractor                  | EV19833-33        | Anello ovale 266x367 mm   | EV19820-02 |
| Ratchet Mechanism (2 ea)           | EV19820-10        | Anello a segmento 266x495 mm  | EV19820-03 |
| Tilt Ratchet Mechanism (6 ea)      | EV19820-20        | Retratore malleabile 38x152 mm  | EV19824-06 |
| Segmented Ring                     | EV19820-03        | Retratore malleabile 76x152 mm  | EV19826-06 |
| 1 1/2" X 6" Malleable Retractor    | EV19824-06        | Valva Kelly, 51x127 mm  | EV19822-25 |
| 3" x 6" Malleable Retractor        | EV19826-06        | Valva Kelly, 51x152 mm  | EV19822-26 |
| 2" X 5" Kelly Retractor            | EV19822-25        | Barra flessibile orizzontale  | EV19821-03 |
| 2" X 6" Kelly Retractor            | EV19822-26        | Retratore Harrington 63x143 mm  | EV19831-25 |
| Horizontal Flex Bar                | EV19821-03        | Retratore con punta Gelpi   | EV19834-01 |
| Harrington Retractor               | EV19831-25        |   |            |
| Gelpi Retractor                    | EV19834-01        |   |            |
| <i>Accessories</i>                 |                   | <i>Accessori:</i>   |            |
| Table Fixation & Ring Case         | EV19820-90        | Container vuoto in acciaio inox dotato con griglia interna                                      |            |
| Blades & Accessories Case          | EV19820-91        | Descrizione   |            |
|                                    |                   | Container in acciaio inox dotato di griglia interna per Accessori di fissazione, anelli e barre | EV19820-90 |
|                                    |                   | Container in acciaio inox dotato di griglia interna per morsetti e divaricatori                 | EV19820-91 |



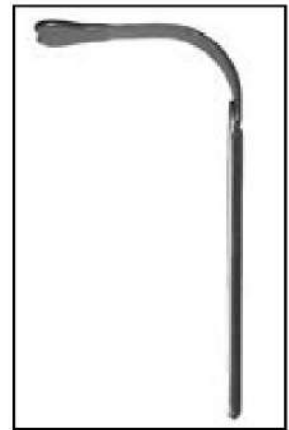
**Malleable Retractors with Protective Edge**



| Description                | Product No |
|----------------------------|------------|
| 1 1/2" x 6"<br>38 x 152 mm | EV19824-06 |
| 2" x 6"<br>51 x 152 mm     | EV19825-06 |
| 3" x 6"<br>76 x 152 mm     | EV19826-06 |

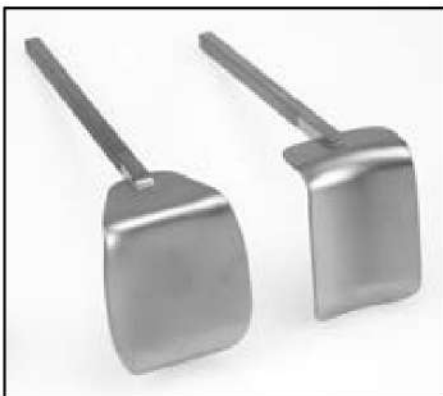
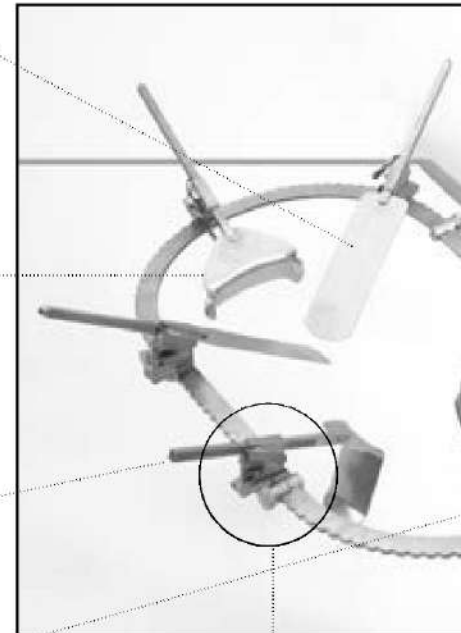
**Harrington Retractors**

| Description                        | Product No |
|------------------------------------|------------|
| Blade 2.5" x 5 5/8"<br>63 x 143 mm | EV19831-25 |



**Specialty Retractors**

| Description                                    | Product No |
|--|------------|
| Balfour Retractor<br>2 5/8" x 3"<br>67 x 76 mm | EV19833-33 |
| Gelpi Point Retractor                          | EV19834-01 |



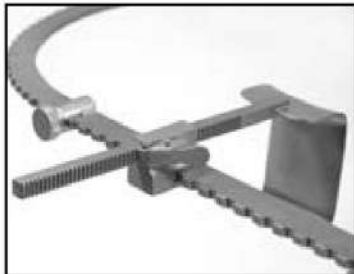
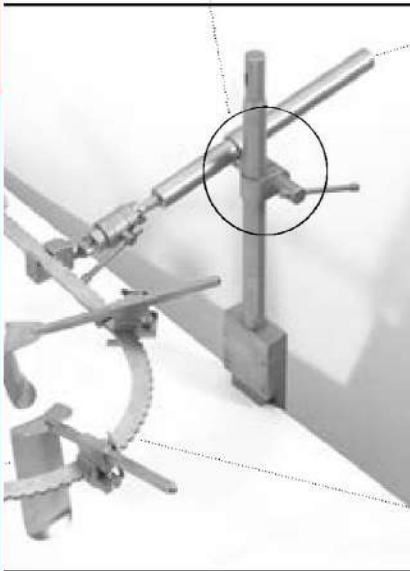
| Description       | Product No  | Description | Product No        |            |
|-------------------|-------------|-------------|-------------------|------------|
| Blade 2" x 1 1/2" | 51 x 38 mm  | EV19822-21  | Blade 1" x 1 1/2" | EV19822-01 |
| Blade 2" x 2"     | 51 x 51 mm  | EV19822-22  | Blade 1" x 2"     | EV19822-02 |
| Blade 2" x 2 1/2" | 51 x 64 mm  | EV19822-22L |                   |            |
| Blade 2" x 3"     | 51 x 76 mm  | EV19822-23  |                   |            |
| Blade 2" x 4"     | 51 x 102 mm | EV19822-24  |                   |            |
| Blade 2" x 5"     | 51 x 127 mm | EV19822-25  |                   |            |
| Blade 2" x 6"     | 51 x 152 mm | EV19822-26  |                   |            |

**Tilt Ratchet Mechanism** allows extensions or retractions along the horizontal axis and allows vertical movement of retractor blade with a second ratchet

**Product No EV19820-20**

**Table Mounting Components**

| Description     | Product No |
|-----------------|------------|
| 1" Post Coupler | EV19821-04 |



**Fixed Ratchet Mechanism** allows extension or retraction along the horizontal axis at 2mm intervals

**Product No** EV19820-10



**Table Mounting Components**

|                     |            |
|---------------------|------------|
| Table Post          | EV19821-01 |
| Horizontal Bar      | EV19821-02 |
| Horizontal Flex Bar | EV19821-03 |



**Retractor Rings**

| Description   | Product No |
|---|------------|
| Oval Ring 10.5 x 14.5 inch / 266 x 367 mm   | EV19820-02 |
| Segmented Ring 10.5 x 19.5 inch / 266 x 495 mm<br>(Consists of one 10.5 inch Round Ring and two 8 inch straight segments) | EV19820-03 |

Laminektomiespreizer  
Laminectomy Retractors  
Separadores para laminectomia  
Divaricatori per laminectomia



SCOVILLE-HAVERFIELD  
EV19910-00  
Rahmen allein  
Frame only  
Marco solo  
Telaio solo



SCOVILLE  
EV19911-00  
Rahmen allein  
Frame only  
Marco solo  
Telaio solo



SCOVILLE  
50 mm, 2"  
EV19912-50



SCOVILLE  
70 mm, 2 3/4"  
EV19912-70



SCOVILLE  
EV19914-41 41 x 38 mm  
EV19914-67 67 x 44 mm



TAYLOR  
EV19915-48 48 x 50 mm  
EV19915-64 64 x 50 mm  
EV19916-64 64 x 64 mm  
EV19916-80 80 x 57 mm



SCOVILLE  
50 mm, 2"  
EV19913-50



SCOVILLE  
70 mm, 2 3/4"  
EV19913-70



SCOVILLE  
EV19917-64 64 x 25 mm  
EV19918-64 64 x 50 mm  
EV19918-88 88 x 25 mm

Wundhaken für plastische Chirurgie  
 Retractors for plastic surgery  
 Separadores para cirugía plástica  
 Divaricatore per chirurgia plastica



mit Kaltlicht + Absaugung  
 with cold light + aspiration  
 con luz fria + aspiracion  
 con luce fredda + aspirazione

**TEBBETTS**

- EV19980-01 80 mm x 16 mm
- EV19980-02 100 mm x 25 mm
- EV19980-03 120 mm x 25 mm
- EV19980-04 120 mm x 30 mm
- EV19980-05 150 mm x 25 mm
- EV19980-06 150 mm x 30 mm

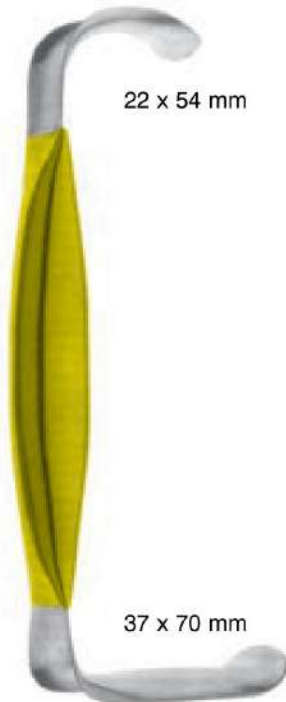


**FERRIERA**

- EV19960-01 80 mm x 16 mm
- EV19960-02 100 mm x 25 mm
- EV19960-03 120 mm x 25 mm
- EV19960-04 120 mm x 30 mm
- EV19960-05 150 mm x 25 mm
- EV19960-06 150 mm x 30 mm



Wundhaken für plastische Chirurgie  
 Retractors for plastic surgery  
 Separadores para cirugía plástica  
 Divaricatore per chirurgia plastica



22 x 54 mm

37 x 70 mm

**BREAST**  
 EV19970-01  
 31 cm, 12 1/4"



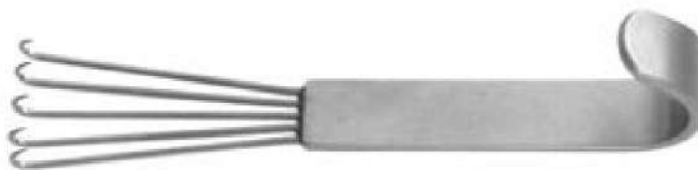
**CORONAL**  
 EV19980-18  
 18 cm, 7"



**YANCOSKIE**  
 EV19990-18  
 18 cm, 7"



**FREEMAN**  
 EV19995-38 18 cm, 7"  
 38 mm, 1 1/2" wide  
 EV19995-22 18 cm, 7"  
 22 mm, 7/8" wide



**ANDERSON**  
 EV19998-03 12 cm, 4 3/4" 3 Zähne  
 3 prongs 3 di-  
 entes 3 uncini  
 EV19998-05 12 cm, 4 3/4"  
 5 Zähne 5  
 prongs  
 5 dientes 5 unci-  
 ni

Sonden  
Probes, Directors  
Sondas, estiletes  
Sonde, specilli



2 mm ø

- 11,5 cm, 4 1/2" EV21102-11
- 13,0 cm, 5 1/8" EV21102-13
- 14,5 cm, 5 3/4" EV21102-14
- 16,0 cm, 6 1/4" EV21102-16
- 18,0 cm, 7" EV21102-18
- 20,0 cm, 8" EV21102-20
- 25,0 cm, 10" EV21102-25



1 mm ø

- EV21104-11
- EV21104-13
- EV21104-14
- EV21104-16
- EV21104-18
- EV21104-20
- EV21104-25



2 mm ø

- EV21106-11
- EV21106-13
- EV21106-14
- EV21106-16
- EV21106-18
- EV21106-20
- EV21106-25



EV21108-14  
14,5 cm, 5 3/4"



BRODIE  
EV21109-18  
18 cm  
7"



- 13,0 cm, 5 1/8" EV21110-13
- 14,5 cm, 5 3/4" EV21110-14
- 16,0 cm, 6 1/4" EV21110-16
- 18,0 cm, 7" EV21110-18
- 20,0 cm, 8" EV21110-20



DOYEN  
EV21111-14  
14 cm  
5 1/2"



EV21112-14  
14,5 cm  
5 3/4"



STACKE  
EV21115-10  
10,5 cm  
4.1"



NELATON  
EV21120-16  
16 cm  
6 1/4"



FISH  
EV21121-14  
14 cm, 5 1/2"  
EV21121-18  
18 cm, 7"



WATSON-CHEYNE  
EV21122-13  
13 cm, 5 1/8"  
EV21122-18  
18 cm, 7"

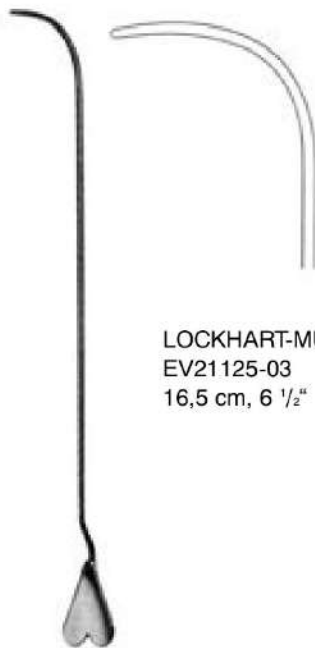
Fistelsonden  
Fistula Probes  
Sondas para fistula  
Sonde per fistole



LOCKHART-MUMMERY  
EV21125-01  
16,5 cm, 6 1/2"



LOCKHART-MUMMERY  
EV21125-02  
16,5 cm, 6 1/2"



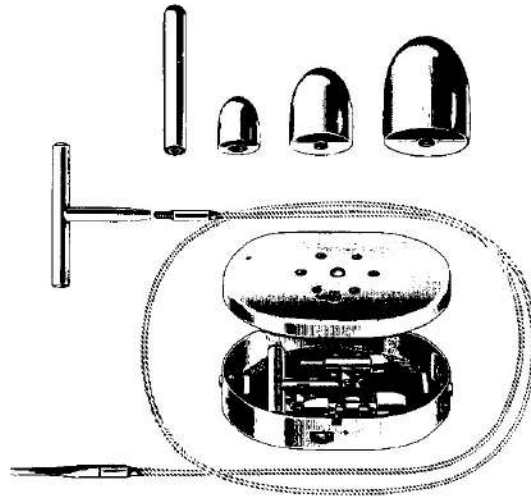
LOCKHART-MUMMERY  
EV21125-03  
16,5 cm, 6 1/2"



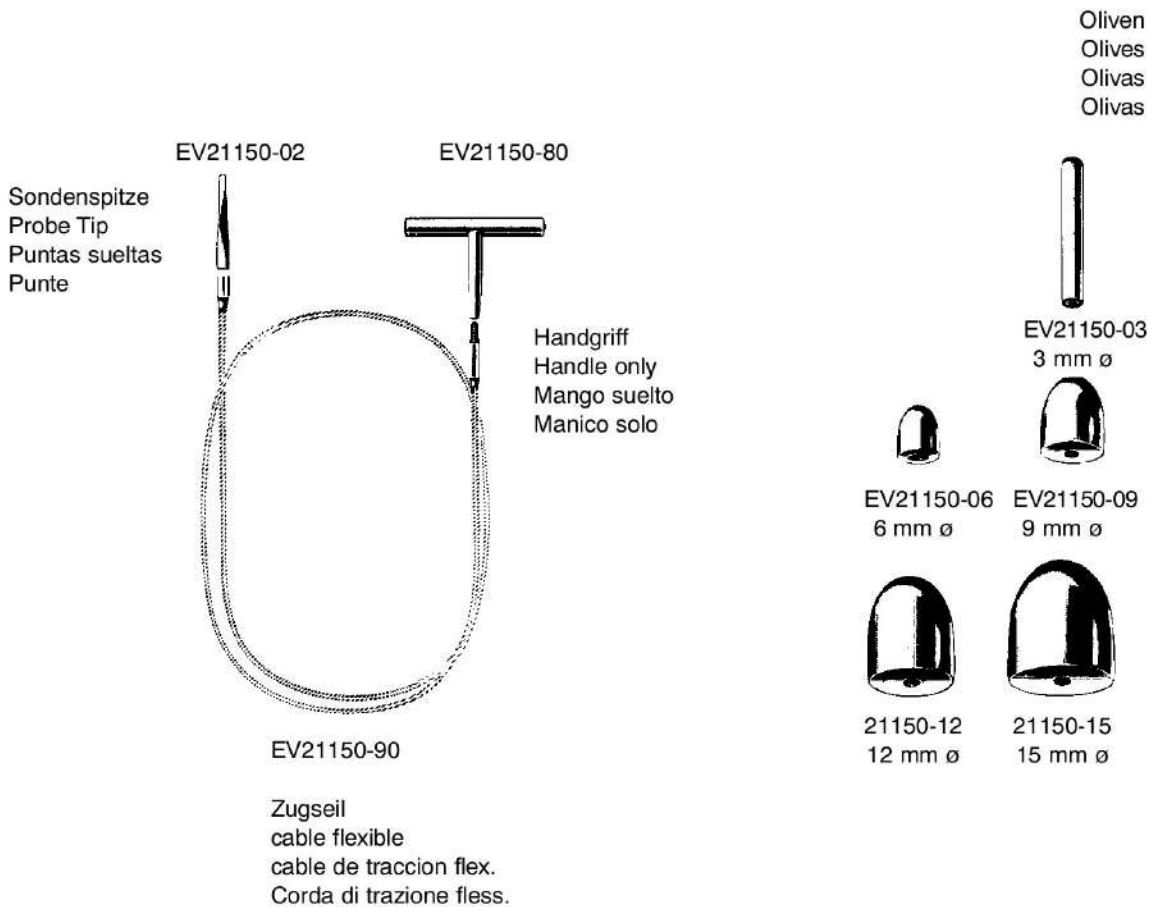
LOCKHART-MUMMERY  
EV21125-04  
16,5 cm, 6 1/2"



Krampfader-Besteck in Metalletui  
 Varicose vein probe set in metal case  
 Juego para várices en estuche de metal  
 Astuccio per varici in scatola di metallo



NABATOFF  
 EV21150-00  
 135x100x25 mm  
 compl.





VARADY  
 EV21154-01  
 180 mm, 7"



VARADY  
 EV21154-02  
 180 mm, 7"



VARADY  
 EV21154-03  
 180 mm, 7"



VARADY  
 EV21154-04  
 175 mm, 6.9"

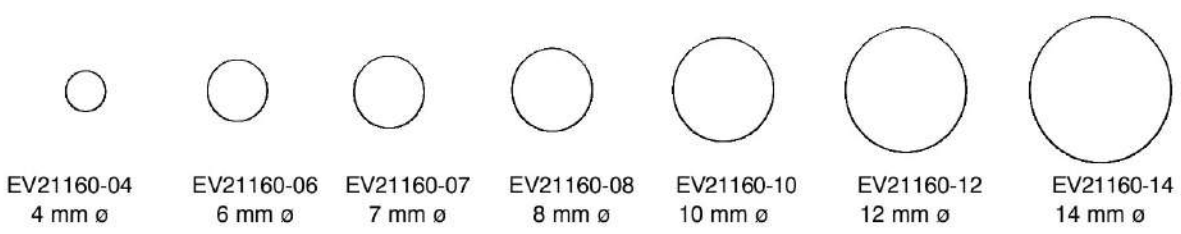
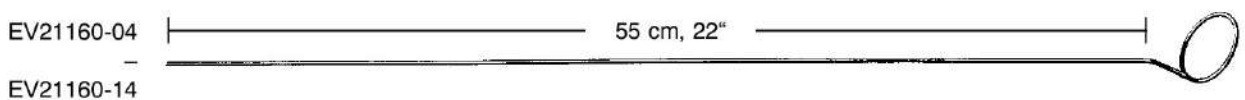


VARADY  
 EV21154-05  
 170 mm, 6 3/4"



VARADY  
 EV21154-06  
 170 mm, 6 3/4"

EV21162-12  
 12 cm, 4 3/4"  
 Griff Handle  
 Mango  
 Manico



EV21160-04 4 mm ø    EV21160-06 6 mm ø    EV21160-07 7 mm ø    EV21160-08 8 mm ø    EV21160-10 10 mm ø    EV21160-12 12 mm ø    EV21160-14 14 mm ø

Watteträger, Spatel  
Cotton Applicators, Spatulas  
Porta-algodones, Espátulas  
Portacotone, Spatole



FARRELL

|        |            |         |
|--------|------------|---------|
| 4 3/4" | EV21270-12 | 12,0 cm |
| 5 1/2" | EV21270-14 | 14,0 cm |
| 6 1/2" | EV21270-16 | 16,5 cm |
| 7"     | EV21270-18 | 18,0 cm |
| 9"     | EV21270-23 | 23,0 cm |



FARRELL

|            |         |
|------------|---------|
| EV21272-12 | 12,0 cm |
| EV21272-14 | 14,0 cm |
| EV21272-16 | 16,5 cm |
| EV21272-18 | 18,0 cm |
| EV21272-23 | 23,0 cm |



ELGEN

|        |            |         |
|--------|------------|---------|
| 4 3/4" | EV21290-12 | 12,0 cm |
| 5 1/2" | EV21290-14 | 14,0 cm |
| 6 1/4" | EV21290-16 | 16,0 cm |
| 7"     | EV21290-18 | 18,0 cm |



1,5



1,5

ELGEN

|            |         |
|------------|---------|
| EV21292-12 | 12,0 cm |
| EV21292-14 | 14,0 cm |
| EV21292-16 | 16,0 cm |
| EV21292-18 | 18,0 cm |

Spatel  
Plaster spatula  
Espátula  
Spatole



EV21190-14  
14,5 cm, 5 3/4"



UCKERMANN  
EV21310-15  
15 cm, 6"

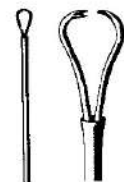
ø 3 mm



JOBSON-HORNE  
EV21320-12 12 cm, 4 3/4"  
EV21320-18 18 cm, 7"

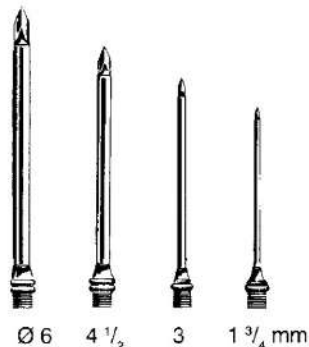


TOBOLD  
EV21331-25  
25 cm, 10"



EV21340-45  
45 cm, 17 3/4"

Trokare  
Trocars  
Trócares  
Trequarti



UNIVERSAL  
EV23104-00  
compl.



STANDARD (NELSON)  
EV23110-30 3,0 mm Ø  
EV23110-35 3,5 mm Ø  
EV23110-40 4,0 mm Ø  
EV23110-45 4,5 mm Ø  
EV23110-50 5,0 mm Ø  
EV23110-55 5,5 mm Ø  
EV23110-60 6,0 mm Ø



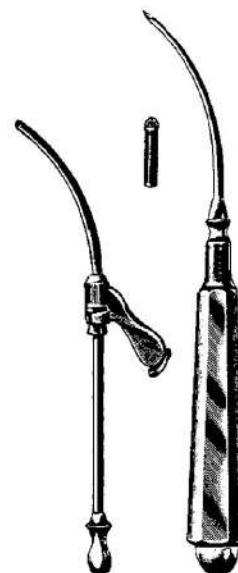
PIERCE  
EV23123-30 3,0 mm Ø  
EV23123-40 4,0 mm Ø  
EV23123-50 5,0 mm Ø



DOUGLAS  
EV23125-11 3 mm Ø



LICHTWITZ  
EV23128-19 1,75 mm Ø



COAKLEY  
EV23140-02 2,25 mm Ø

Trokare  
Trocars  
Trócares  
Trequarti



|         |            |
|---------|------------|
| Charr./ |            |
| F.G.    | OCHSNER    |
| 10      | EV23150-10 |
| 12      | EV23150-12 |
| 14      | EV23150-14 |
| 16      | EV23150-16 |
| 18      | EV23150-18 |
| 20      | EV23150-20 |



|         |            |         |
|---------|------------|---------|
| Charr./ |            |         |
| F.G.    | NELSON     | ø       |
| 25      | EV23170-25 | 7,5 mm  |
| 30      | EV23170-30 | 9,0 mm  |
| 33      | EV23170-33 | 10,5 mm |
| 35      | EV23170-35 | 12,0 mm |



SINOSKOPIE-TROKAR 8,5  
cm, 3.4"

EV23181-40 f. Optik mit Ø 4,0 mm



Biopsiekanülen  
 Biopsy Needles  
 Agujas para biopsia  
 Aghi per biopsia

Nadelführer  
 Pudendus  
 Anesthésie  
 anestesia



IOWA  
 EV23210-00  
 14 cm, 5 1/2"  
 compl.

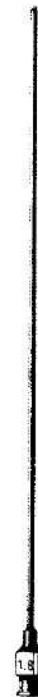
Pneumoperitoneum  
 Pneumoperitoneum  
 Neumoperitoneo  
 Pneumoperitoneo



VERRES  
 EV23250-20 2,00x100 mm  
 EV23250-40 2,00x140 mm

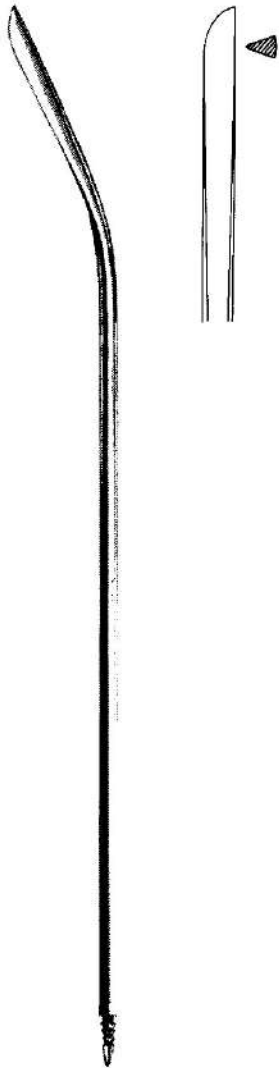


MENGHINI  
 EV23302-01 1,0x 35 mm  
 EV23302-02 1,0x 70 mm  
 EV23302-03 1,2x 70 mm  
 EV23302-04 1,2x100 mm  
 EV23302-05 1,4x 70 mm  
 EV23302-06 1,4x100 mm  
 EV23302-07 1,6x 70 mm  
 EV23302-08 1,8x100 mm



MENGHINI  
 EV23310-14 1,4x168 mm  
 EV23310-18 1,8x168 mm

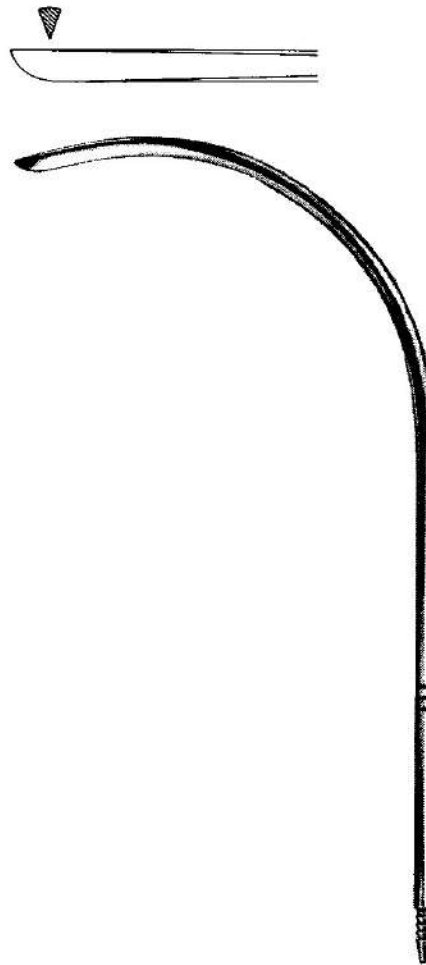
Führungsnadeln  
Guide needles  
Aguja de Guía  
Ago guida



REDON  
EV23195-08 -  
EV23195-18

Messerspitze, gerade  
Guide Needle, straight  
Aguja de guía, recta  
Ago guida, retta

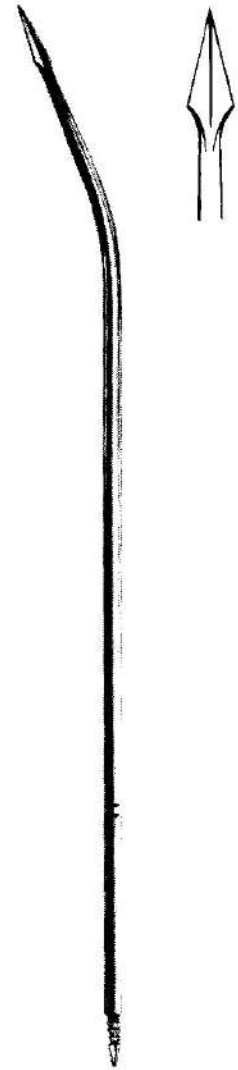
- Charr./Fr.  
8 EV23195-08  
10 EV23195-10  
12 EV23195-12  
14 EV23195-14  
16 EV23195-16  
18 EV23195-18



REDON  
EV23197-08 -  
EV23197-18

Messerspitze, gebogen  
Guide Needle, curved  
Aguja de guía, curva  
Ago guida, curva

- Charr./Fr.  
8 EV23197-08  
10 EV23197-10  
12 EV23197-12  
14 EV23197-14  
16 EV23197-16  
18 EV23197-18



REDON  
EV23198-08 -  
EV23198-18

Lanzettspitze, gerade  
Lancet tip, straight  
Punta lanceolar, recta  
Punta lanceolata, retta

- Charr./Fr.  
8 EV23198-08  
10 EV23198-10  
12 EV23198-12  
14 EV23198-14  
16 EV23198-16  
18 EV23198-18

Nadelhalter  
Needle Holders  
Porta-agujas  
Port'aghi

GERNAL SURGICAL



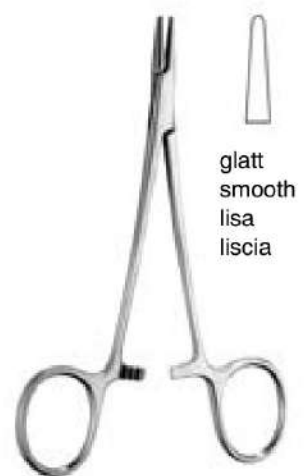
**DERF**  
EV25110-12 12 cm, 4 <sup>3</sup>/<sub>4</sub>"  
EV25114-12 TC 12 cm, 4 <sup>3</sup>/<sub>4</sub>"



**DERF**  
EV25120-12 12,5 cm, 5"



**COLLIER**  
EV25122-12 12,5 cm, 5"



**WEBSTER**  
EV25128-13 13 cm, 5 <sup>1</sup>/<sub>8</sub>"  
EV25129-13 TC 13 cm, 5 <sup>1</sup>/<sub>8</sub>"

**BABY-WEBSTER**  
EV25136-11 11 cm, 4 <sup>3</sup>/<sub>8</sub>"  
EV25137-11 TC 11 cm, 4 <sup>3</sup>/<sub>8</sub>"  
EV25138-11 TC 11 cm, 4 <sup>3</sup>/<sub>8</sub>"  
gerieft/serrated  
estriada/zigrinato



**HALSEY**  
EV25130-13 EV25140-13  
EV25134-13 TC EV25144-13 TC  
13 cm, 5 <sup>1</sup>/<sub>8</sub>"



**NEIVERT**  
EV25146-13 EV25148-13  
TC 13 cm, 5 <sup>1</sup>/<sub>8</sub>"



**BAUMGARTNER**  
EV25150-12 EV25154-12 TC  
12,5 cm, 5"  
EV25150-14 EV25154-14 TC  
14,0 cm, 5 <sup>1</sup>/<sub>2</sub>"

Nadelhalter  
Needle Holders  
Porta-agujas  
Port'aghi



CRILE-WOOD EV25160-15

- 15 cm, 6" EV25164-15 TC EV25160-18
- 18 cm, 7" EV25164-18 TC EV25160-20
- 20 cm, 8" EV25164-20 TC EV25160-23
- 23 cm, 9" EV25164-23 TC



CRILE-MURRAY

- EV25170-15 EV25174-15
- TC 15 cm, 6"



MAYO-HEGAR

- EV25180-12 12 cm, 4 3/4" EV25184-12 TC
- EV25180-14 14 cm, 5 1/2" EV25184-14 TC
- EV25180-16 16 cm, 6 1/4" EV25184-16 TC
- EV25180-18 18 cm, 7" EV25184-18 TC
- EV25180-20 20 cm, 8" EV25184-20 TC
- EV25180-24 24 cm, 9 1/2" EV25184-24 TC
- EV25180-26 26 cm, 10 1/4" EV25184-26 TC
- EV25180-30 30 cm, 11 3/4" EV25184-30 TC



fein  
fine  
delicate  
fino

MAYO-HEGAR

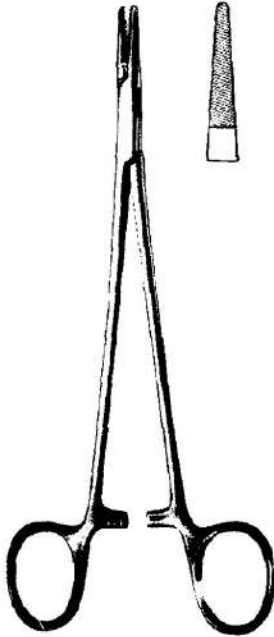
- EV25190-16 16 cm, 6 1/4" EV25194-16 TC
- EV25190-18 18 cm, 7" EV25194-18 TC
- EV25190-20 20 cm, 8" EV25194-20 TC



BROWN

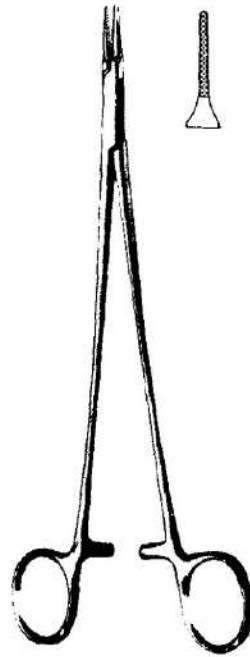
- EV25196-13 13 cm, 5 1/8"
- EV25196-18 18 cm, 7"

Nadelhalter  
Needle Holders  
Porta-agujas  
Port'aghi



DE BAKEY

|               |                |
|---------------|----------------|
| EV25214-16 TC | 16 cm, 6 1/4"  |
| EV25214-18 TC | 18 cm, 7"      |
| EV25214-20 TC | 20 cm, 8"      |
| EV25214-23 TC | 23 cm, 9"      |
| EV25214-26 TC | 26 cm, 10 1/4" |
| EV25214-31 TC | 31 cm, 12 1/4" |

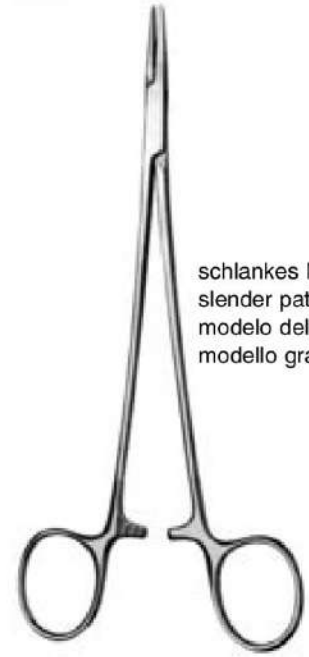


RYDER 1 mm

|               |                |
|---------------|----------------|
| EV25224-13 TC | 13 cm, 5 1/8"  |
| EV25224-15 TC | 15 cm, 6"      |
| EV25224-18 TC | 18 cm, 7"      |
| EV25224-20 TC | 20 cm, 8"      |
| EV25224-23 TC | 23 cm, 9"      |
| EV25224-26 TC | 26 cm, 10 1/4" |

RYDER 2 mm

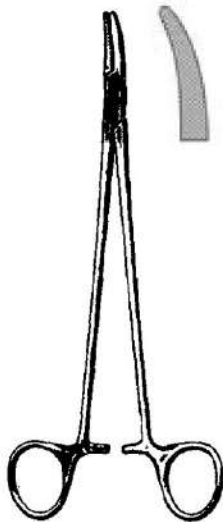
|               |  |
|---------------|--|
| EV25225-13 TC |  |
| EV25225-15 TC |  |
| EV25225-18 TC |  |
| EV25225-20 TC |  |
| EV25225-23 TC |  |
| EV25225-26 TC |  |



schlankes Modell  
slender pattern  
modelo delgado  
modello gracile

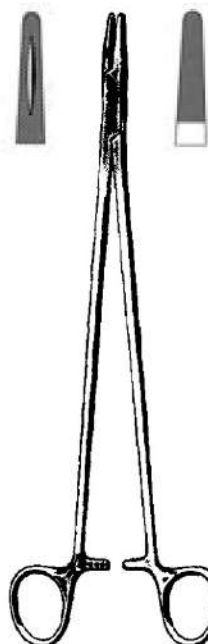
MICROVASCULAR

|               |           |
|---------------|-----------|
| EV25230-18 TC | 18 cm, 7" |
| EV25230-20 TC | 20 cm, 8" |
| EV25230-23 TC | 23 cm, 9" |



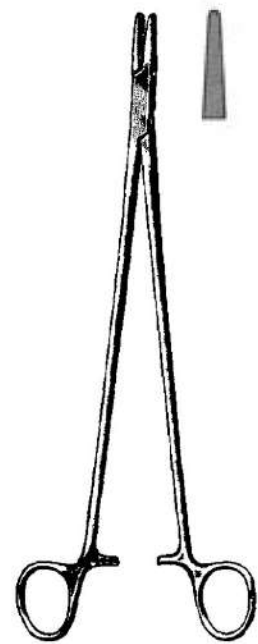
HEANEY

|               |                |
|---------------|----------------|
| EV25241-21    | 21 cm, 8 1/4"  |
| EV25241-26    | 26 cm, 10 1/4" |
| EV25245-21 TC | 21 cm, 8 1/4"  |
| EV25245-26 TC | 26 cm, 10 1/4" |



MASSON

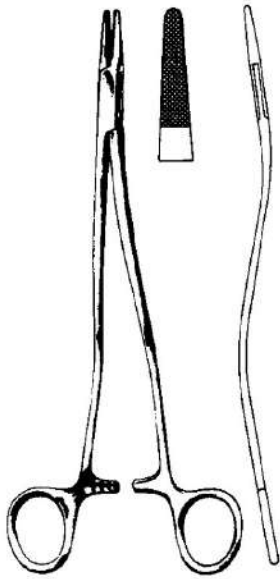
|               |                |
|---------------|----------------|
| EV25250-27    | 27 cm, 10 1/2" |
| EV25254-27 TC | 27 cm, 10 1/2" |



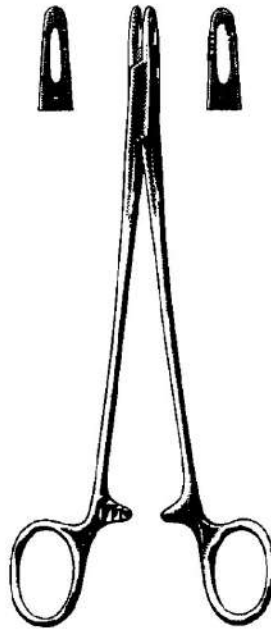
WANGENSTEEN

|               |                |
|---------------|----------------|
| EV25260-27    | 27 cm, 10 1/2" |
| EV25264-27 TC | 27 cm, 10 1/2" |

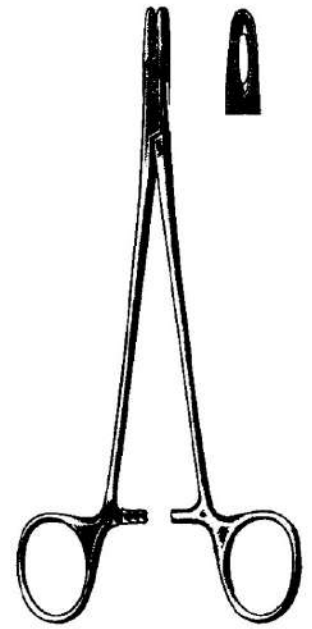
Nadelhalter  
Needle Holders  
Porta-agujas  
Port'aghi



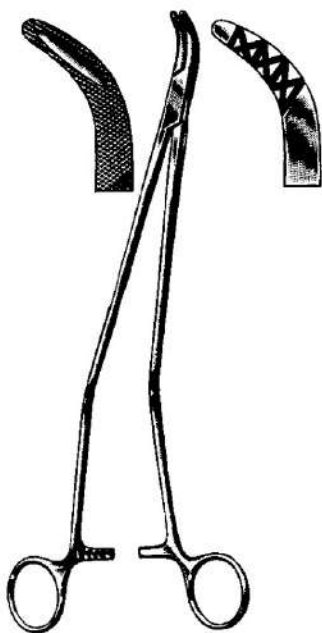
**BOZEMANN**  
 EV25285-20 TC 20 cm, 8"  
 EV25285-24 TC 24 cm, 9 1/2"  
 EV25285-26 TC 26 cm, 10 1/4"



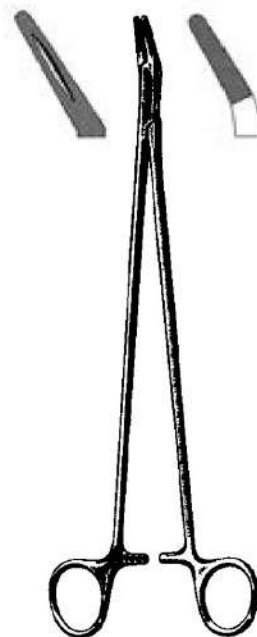
**METZENBAUM**  
 EV25290-18  
 18 cm, 7"



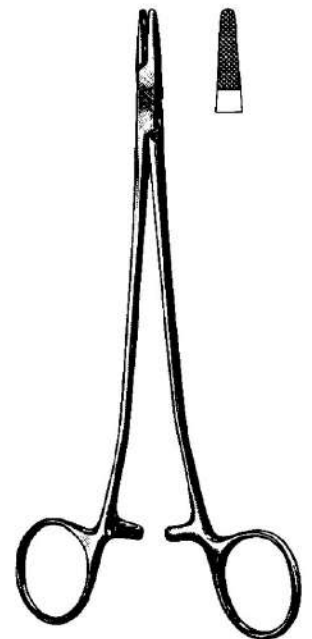
**ADSON**  
 EV25292-18  
 18 cm, 7"



**JOHNSON**  
 EV25293-27  
 27 cm, 10 1/2"

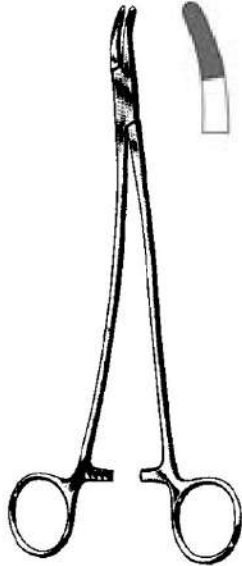


**FINOCHIETTO**  
 EV25311-20 20 cm, 8" EV25315-20 TC  
 EV25311-27 27 cm, 10 1/2" EV25315-27 TC



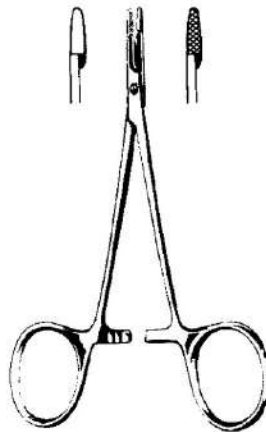
**SAROT**  
 EV25324-18 TC 18 cm, 7"  
 EV25324-26 TC 26 cm, 10 1/4"

Nadelhalter  
Needle Holders  
Porta-agujas  
Port'aghi



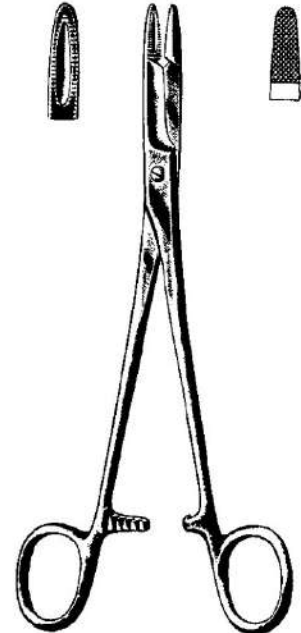
STRATTE

EV25330-21 21 cm, 8 1/4"  
EV25330-23 23 cm, 9" **EV25334-23 TC**



BABY-OLSEN-HEGAR

EV25405-12 EV25406-12  
**EV25408-12 TC EV25407-12 TC**  
11,5 cm, 4 1/2"



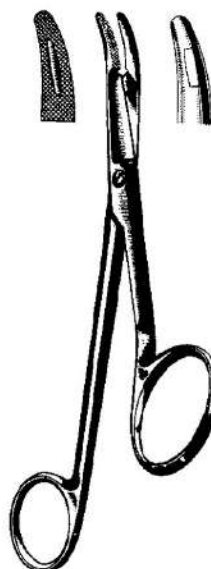
OLSEN-HEGAR

EV25410-14 14 cm, 5 1/2" **EV25414-14 TC**  
EV25410-17 17 cm, 6 3/4" **EV25414-17 TC**  
18 cm, 7" **EV25414-18 TC**



MATHIEU-OLSEN

EV25415-14 TC 14 cm, 5 1/2"  
EV25415-17 TC 17 cm, 6 3/4"  
EV25415-20 TC 20 cm, 8"



GILLIES

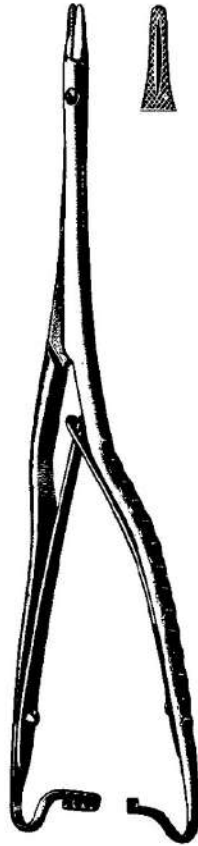
EV25430-16 16 cm, 6 1/4" **EV25434-16 TC**  
11 cm, 4 3/8" **EV25434-11 TC**  
13 cm, 5 1/8" **EV25434-13 TC**



KILNER

EV25436-13 13 cm, 5 1/8"  
**EV25438-13 TC** 13 cm, 5 1/8"

Nadelhalter  
Needle Holders  
Porta-agujas  
Port'aghi



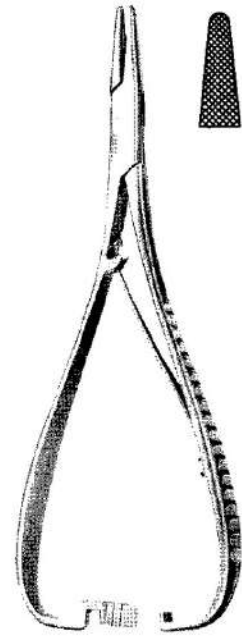
HOESEL

EV25446-25 25 cm, 10"  
EV25447-25 TC 25 cm, 10"



CRILE EV

EV25438-15 15 cm, 6"



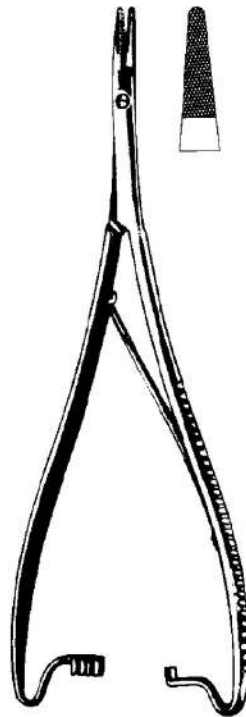
MATHIEU

EV25450-14 14 cm, 5 1/2" EV25452-14 TC  
EV25450-17 17 cm, 6 3/4" EV25452-17 TC  
EV25450-20 20 cm, 8" EV25452-20 TC  
EV25450-24 24 cm, 9 1/2" EV25452-24 TC



LANGENBECK

EV25460-18 TC 18 cm, 7"  
EV25460-20 TC 20 cm, 8"  
EV25460-23 TC 23 cm, 9"



HOESEL

EV25465-20 TC 20 cm, 8"  
EV25465-25 TC 25 cm, 10"



LICHTENBERG

EV25466-17 17 cm, 6 3/4" EV25467-17 TC  
EV25466-20 20 cm, 8" EV25467-20 TC



Nadelhalter  
Needle Holders  
Porta-agujas  
Port'aghi

Oftalmologie  
Ophthalmology  
Oftalmologia  
Oftalmologia



STEVENS  
EV25610-11  
11 cm, 4 <sup>3</sup>/<sub>8</sub>"



STEVENS  
EV25612-13 13 cm, 5 <sup>1</sup>/<sub>8</sub>"  
EV25612-15 15 cm, 6"



BOYNTON  
EV25614-12  
12 cm, 4 <sup>3</sup>/<sub>4</sub>"



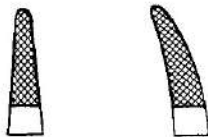
BOYNTON  
EV25615-12 TC  
12 cm, 4 <sup>3</sup>/<sub>4</sub>"



ARRUGA  
EV25620-16 - EV25624-16  
16 cm, 6 <sup>1</sup>/<sub>4</sub>"



EV25620-16 EV25621-16



EV25624-16 TC EV25625-16 TC



KALT-ARRUGA  
EV25627-14  
14 cm, 5 <sup>1</sup>/<sub>2</sub>"



KALT  
EV25628-14  
14 cm, 5 <sup>1</sup>/<sub>2</sub>"

Nadelhalter  
Needle Holders  
Porta-agujas  
Port'aghi



EV25670-14  
glatt smooth  
lisa  
liscia



EV25672-14  
gerieft  
serrated  
estriada zi-  
grinato



EV25676-14 TC



EV25671-14  
glatt smooth  
lisa  
liscia



EV25673-14  
gerieft  
serrated  
estriada zi-  
grinato



EV25677-14 TC

JACOBSEN

- EV25667-18 18 cm, 7"
- EV25668-18 TC 18 cm, 7"
- EV25667-21 21 cm, 8 1/4"
- EV25668-21 TC 21 cm, 8 1/4"

CASTROVIEJO

14 cm, 5 1/2"



EV25678-09



EV25679-09



CASTROVIEJO-MICRO  
9 cm, 3 1/2"



CASTROVIEJO

- EV25680-13 13 cm, 5 1/8"
- EV25684-13 TC 13 cm, 5 1/8"

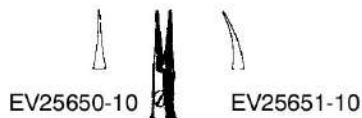
Mikro-Nadelhalter  
 Micro-Needle Holders  
 Micro-Porta-agujas  
 Micro-Port'aghi



CASTROVIEJO-STANDARD  
 EV25678-14 14 cm, 5 1/2"

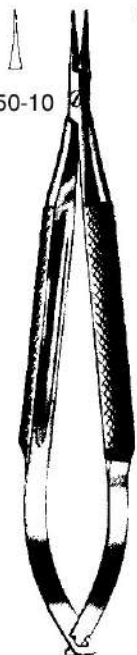


CASTROVIEJO-STANDARD  
 EV25679-14 14 cm, 5 1/2"

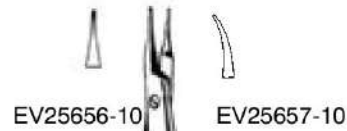


EV25650-10

EV25651-10



BARRAQUER  
 10 cm, 4"



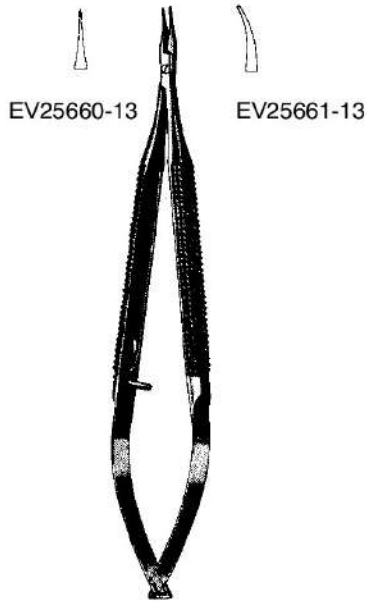
EV25656-10

EV25657-10

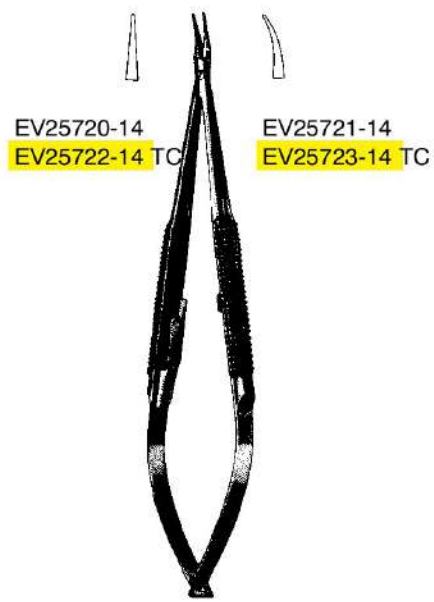


BARRAQUER-TROUTMAN  
 10 cm, 4"

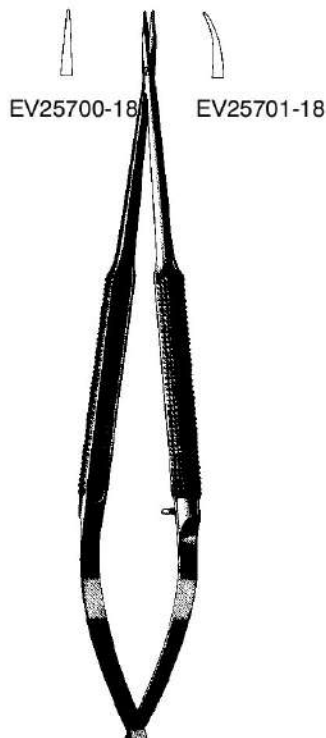




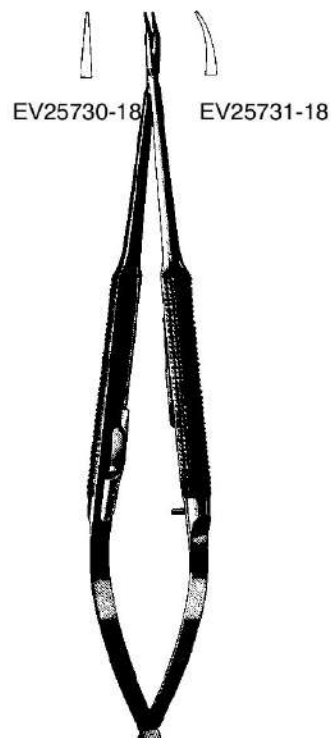
BARRAQUER  
 13 cm, 5 1/8"



BARRAQUER  
 14 cm, 5 1/2"



BARRAQUER  
 18 cm, 7"



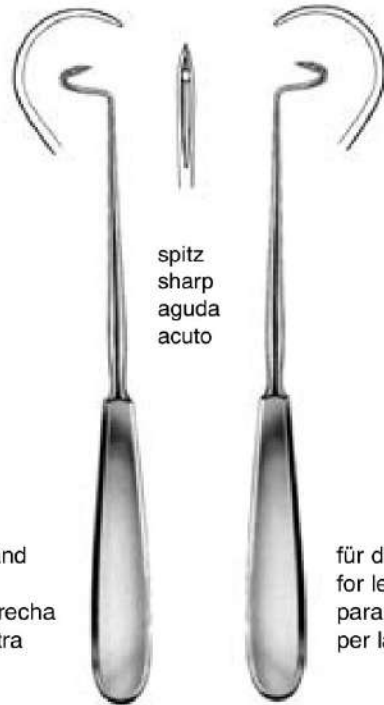
BARRAQUER  
 18 cm, 7"

Unterbindungsnadeln  
Ligature Needles  
Agujas para ligaduras  
Aghi per legature



biegsam  
malleable  
maleable  
malleabile

EV27109-20  
20 cm, 8"

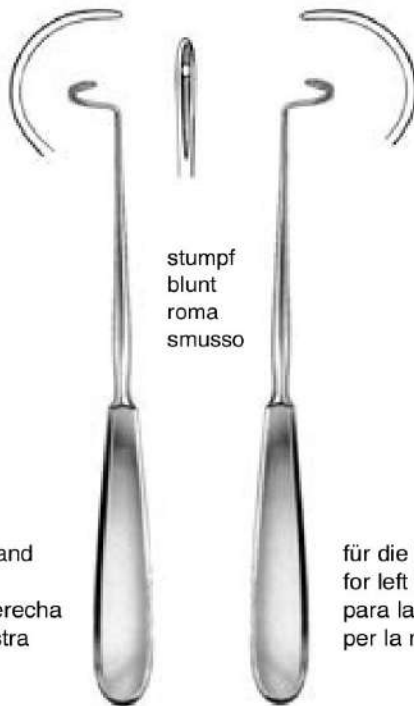


spitz  
sharp  
aguda  
acuto

für die rechte Hand  
for right hand  
para la mano derecha  
per la mano destra

für die linke Hand  
for left hand  
para la mano izquierda  
per la mano sinistra

DESCHAMPS  
EV27110-21 21 cm, 8 1/4" EV27111-21  
EV27110-24 24 cm, 9 1/2" EV27111-24  
EV27110-27 27 cm, 10 1/2" EV27111-27



stumpf  
blunt  
roma  
smusso

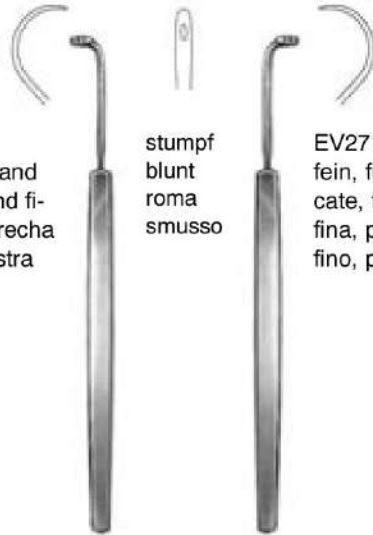
für die rechte Hand  
for right hand  
para la mano derecha  
per la mano destra

für die linke Hand  
for left hand  
para la mano izquierda  
per la mano sinistra

DESCHAMPS  
EV27120-21 21 cm, 8 1/4" EV27121-21  
EV27120-24 24 cm, 9 1/2" EV27121-24  
EV27120-27 27 cm, 10 1/2" EV27121-27

Unterbindungsnadeln  
Ligature Needles  
Agujas para ligaduras  
Aghi per legature

EV27130-13  
fein, für die rechte Hand  
delicate, for right hand  
fina, para la mano derecha  
fino, per la mano destra



KRONECKER  
13 cm, 5 1/8"

stumpf  
blunt  
roma  
smusso

EV27131-13  
fein, für die linke Hand deli-  
cate, for left hand  
fina, para la mano izquierda  
fino, per la mano sinistra



SCHMIEDEN-DICK  
EV27134-32 32 cm, 12 3/4" biegsam -  
malleable - maleable - malleabile

EV27133-24  
für die rechte Hand  
for right hand  
para la mano derecha  
per la mano destra



stumpf  
blunt  
roma  
smusso



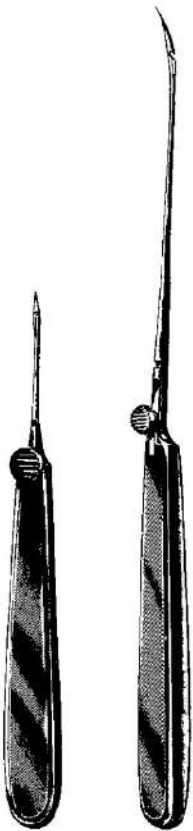
NELSON  
24,5 cm, 9 3/4"

EV27135-24  
für die linke Hand  
for left hand  
para la mano izquierda  
per la mano sinistra



COOPER EV27139-19  
19 cm, 7 1/2"

Nahtinstrumente  
Suturing Instruments  
Instrumentos para suturas  
Strumenti per suture



REVERDIN  
EV27201-15 - EV27204-21



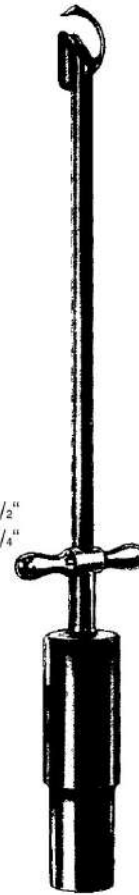
Fig. 1 2

EV27201-15 15 cm, 6"  
EV27201-19 19 cm, 7 1/2"  
EV27201-21 21 cm, 8 1/4"



Fig. 2

EV27202-15 15 cm, 6"  
EV27202-19 19 cm, 7 1/2"  
EV27202-21 21 cm, 8 1/4"



YOUNG BOOMERANG  
EV27240-00  
25 cm, 10"



Fig. 1  
EV27240-01



Fig. 2  
EV27240-02



Fig. 3  
EV27240-03



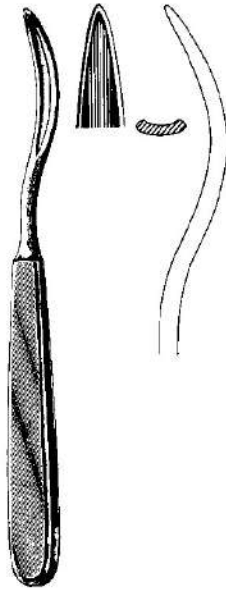
Fig. 3

EV27203-15 15 cm, 6"  
EV27203-19 19 cm, 7 1/2"  
EV27203-21 21 cm, 8 1/4"

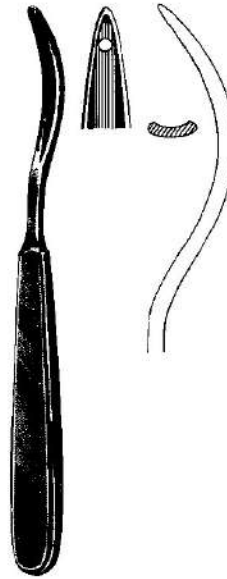


Fig. 4

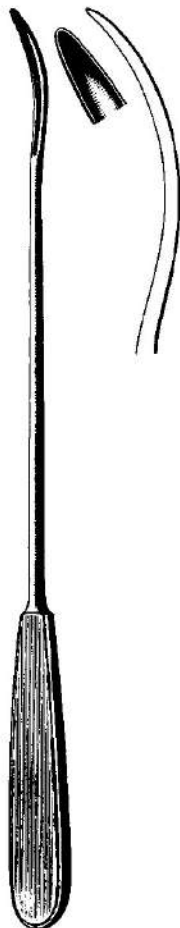
EV27204-15 15 cm, 6"  
EV27204-19 19 cm, 7 1/2"  
EV27204-21 21 cm, 8 1/4"



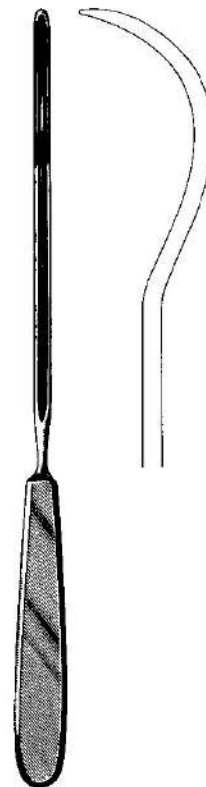
SCHMIEDEN  
EV27271-19 19 cm, 7 1/2"



SCHMIEDEN-PAYR  
EV27273-19 19 cm, 7 1/2"



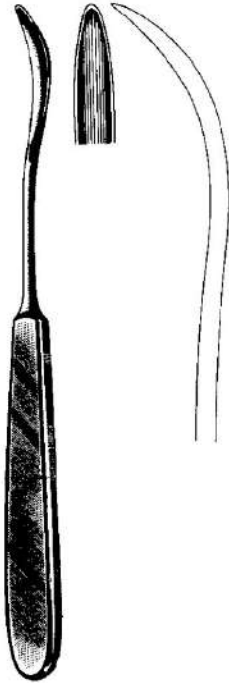
BRUNNER  
EV27275-30 30 cm, 11 3/4"



KIRSCHNER  
EV27277-25 25,5 cm, 10"



Führungshohlsonden, Fadenfänger, Fadengabel  
 Ligature Conductors, Ligature Catcher, Ligature Adjuster  
 Sondas conductoras, Captador de hilos, Horquilla de hilos  
 Sonde conduttrici, Portalegature, Forchetta da sutura



KOENIG  
 EV27285-20  
 20 cm, 8"



PAYR  
 EV27288-22  
 22 cm, 8 3/4"



PAYR  
 EV27289-22  
 22 cm, 8 3/4"

Plastik  
 plastic  
 plástico



BRUNNER  
 EV27291-18 18 cm, 7"  
 EV27291-27 27 cm, 10 1/2"



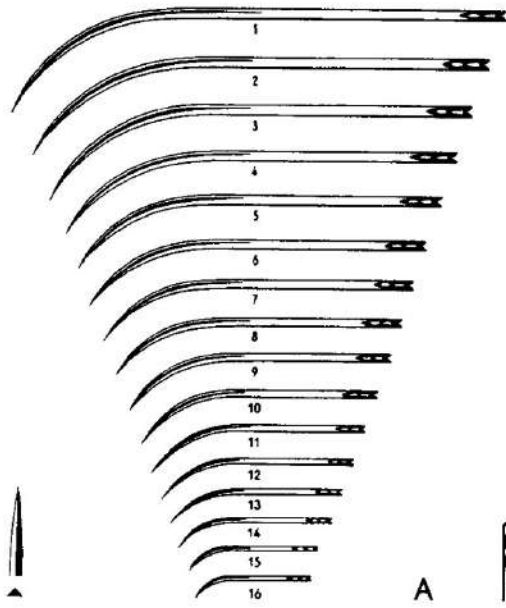
VIENNA  
 EV27297-23  
 23,5 cm, 9 1/4"



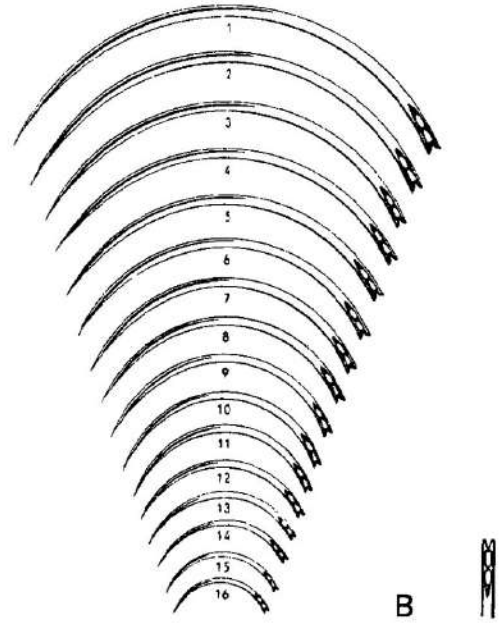
ELGEN  
 EV27298-23  
 23 cm, 9"

Chirurgische Nadeln  
Suturing Needles  
Agujas para suturas  
Aghi per suture

Pack à 1 Dutzend  
in packages of 1 dozen  
en sobres de 1 docena  
confezione 1 dozzina



EV27403-01 - EV27403-16



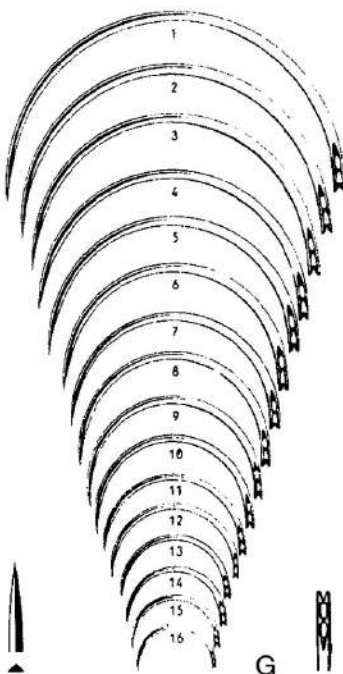
EV27413-01 - EV27413-16

Fig. 1 2 3 4 5 6 7 8 9 10 11 12 13 14 15 16

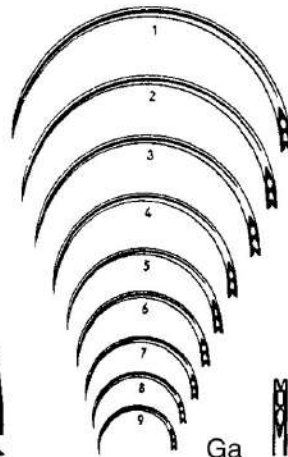
A EV27403-01 EV27403-02 EV27403-03 EV27403-04 EV27403-05 EV27403-06 EV27403-07 EV27403-08 EV27403-09 EV27403-10 EV27403-11 EV27403-12 EV27403-13 EV27403-14 EV27403-15 EV27403-16  
B EV27413-01 EV27413-02 EV27413-03 EV27413-04 EV27413-05 EV27413-06 EV27413-07 EV27413-08 EV27413-09 EV27413-10 EV27413-11 EV27413-12 EV27413-13 EV27413-14 EV27413-15 EV27413-16

G EV27423-01 EV27423-02 EV27423-03 EV27423-04 EV27423-05 EV27423-06 EV27423-07 EV27423-08 EV27423-09 EV27423-10 EV27423-11 EV27423-12 EV27423-13 EV27423-14 EV27423-15 EV27423-16  
Ga EV27433-01 EV27433-02 EV27433-03 EV27433-04 EV27433-05 EV27433-06 EV27433-07 EV27433-08 EV27433-09 EV27433-10 EV27433-11  
Gr EV27434-01 EV27434-02 EV27434-03 EV27434-04 EV27434-05 EV27434-06 EV27434-07 EV27434-08 EV27434-09 EV27434-10 EV27434-11 EV27434-12 EV27434-13 EV27434-14 EV27434-15 EV27434-16

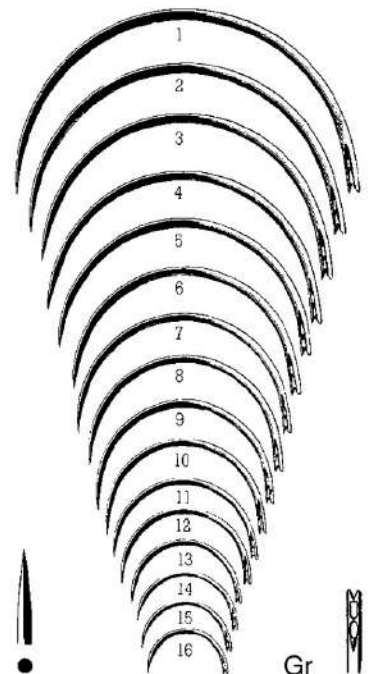
Alle Nadeln mit Öhr  
all the needles with spring eye  
todas las agujas con ojo a resorte  
tutti gli aghi con cruna aperta



EV27423-01 - EV27423-16

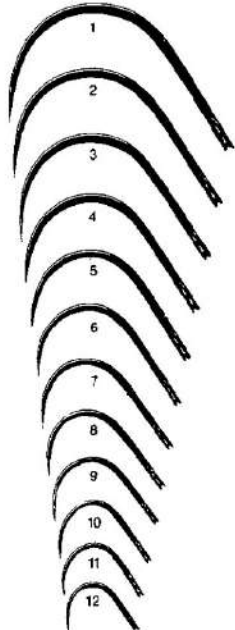


EV27433-01 - EV27433-09



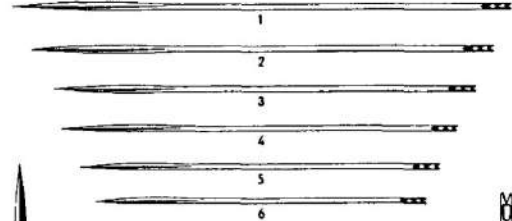
EV27434-01 - EV27434-16

Alle Nadeln mit Öhr  
all the needles with spring eye  
todas las agujas con ojo a resorte  
tutti gli aghi con cruna aperta

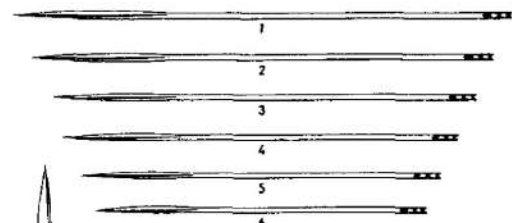


EV27441-01 - EV27441-12

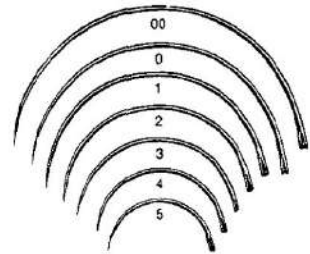
Chirurgische Nadeln  
Suturing Needles  
Agujas para suturas  
Aghi per suture



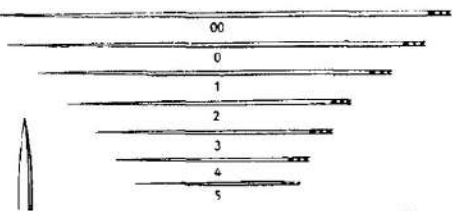
KEITH  
EV27450-01 - EV27450-06



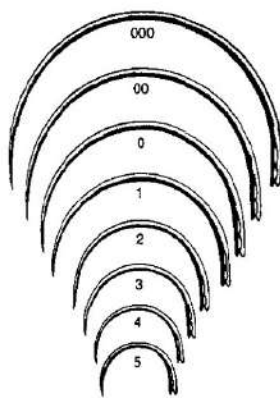
KEITH  
EV27452-01 - EV27452-06



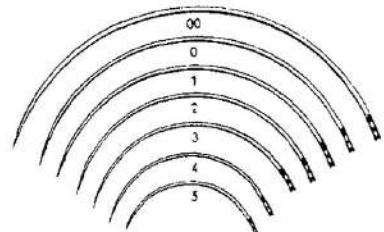
EV27465-20 - EV27467-05 Pb



EV27475-20 - EV27477-05 Pc



EV27443-30 - EV27443-05



EV27485-20 - EV27487-05 Pd

|       |     |    |   |   |   |   |   |   |   |   |   |   |    |    |    |
|-------|-----|----|---|---|---|---|---|---|---|---|---|---|----|----|----|
| FIG.  | 000 | 00 | 0 | 1 | 2 | 3 | 4 | 5 | 6 | 7 | 8 | 9 | 10 | 11 | 12 |
| KÖNIG |     |    |   |   |   |   |   |   |   |   |   |   |    |    |    |
| E     |     |    |   |   |   |   |   |   |   |   |   |   |    |    |    |
| KEITH |     |    |   |   |   |   |   |   |   |   |   |   |    |    |    |
| KEITH |     |    |   |   |   |   |   |   |   |   |   |   |    |    |    |
| Pb    |     |    |   |   |   |   |   |   |   |   |   |   |    |    |    |
| Pc    |     |    |   |   |   |   |   |   |   |   |   |   |    |    |    |
| Pd    |     |    |   |   |   |   |   |   |   |   |   |   |    |    |    |

Wundklammerpinzetten und -zängchen, Wundklammern  
 Clip Applying Forceps, Suture Clips  
 Pinzas aplicadoras para agrafes, Agrafes de sutura  
 Pinze per applicare le agrafe, Agrafe



MICHEL  
EV27610-12  
12 cm, 4 3/4"



WACHENFELDT  
EV27612-12  
12,5 cm, 5"



WACHENFELDT  
EV27614-12  
12,5 cm, 5"



HEGENBARTH  
EV27616-12  
12,5 cm, 5"



CHILDE  
EV27620-18  
18 cm, 7"



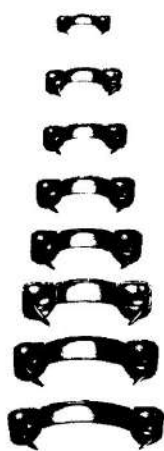
MICHEL  
EV27630-12  
12 cm, 4 3/4"



COLLIN  
EV27640-13  
13 cm, 5 1/8"



RICHTER-HEATH  
EV27642-14  
14 cm, 5 1/2"



MICHEL

- MICHEL mm  
 EV27660-07,5x1,75  
 EV27660-11x1x2  
 EV27660-12x2,5  
 EV27660-14x3  
 EV27660-16x3  
 EV27660-18x3  
 EV27660-20x3  
 EV27660-22x3

Pack à 1000  
 box of 1000  
 paq x 1000  
 confezione x 1000

Nahtbesteck  
Suture Set  
Estuche para suturas  
Set per sutura



STANDARD

EV27680-00  
165 x 90 x 28 mm

Komplett in Metalletui und Plastiktasche mit 2 herausnehmbaren gelochten Einlagen mit Stegen für Instrumente

Bestehend aus:

- 1 Mathieu Nadelhalter 14 cm (5<sup>1</sup>/<sub>2</sub>"
- 1 Nähseide in Alkohol
- 6 Nähnadeln sortiert
- 1 Nadeldose gelocht 65 x 42 cm
- 1 Michel Wundklammerzange
- 20 Wundklammern auf Halter
- 1 Skalpellgriff mit Klinge
- 3 Klingen auswechselbar
- 1 Schere st/sp. 13 cm (5") gerade
- 1 anat. Pinzette 11,5 cm (4<sup>1</sup>/<sub>2</sub>"
- 1 Hakenpinzette 1 x 2 Z. 12 cm (4<sup>3</sup>/<sub>4</sub>"
- 1 Hunter Splitterpinzette 10,5 cm (4<sup>1</sup>/<sub>4</sub>"
- 1 Kocher Arterienklemme 13 cm (5")
- 1 Myrtenblattsonde 13 cm (5")

Complete in metal case with plastic pouch and 2 removable perforated trays for instruments

Contents:

- 1 Mathieu Needle Holder, 14 cm (5<sup>1</sup>/<sub>2</sub>"
- 1 Flacon with sterilized silk in alcohol
- 6 Suture Needles, assorted
- 1 Needle Case, 25.6" x 16.5", perforated
- 1 Michel Suture Clip Forceps
- 20 Michel Suture Clips with Clip Holder
- 1 Scalpel Handle with Blade
- 3 Scalpel Blades, interchangeable
- 1 Scissors, straight, blunt/sharp, 13 cm (5")
- 1 Dressing Forceps, 11,5 cm (4<sup>1</sup>/<sub>2</sub>"
- 1 Tissue Forceps, 12 cm (4<sup>3</sup>/<sub>4</sub>"), 1 x 2 teeth
- 1 Hunter Splinter Forceps, 10,5 cm (4<sup>1</sup>/<sub>4</sub>"
- 1 Kocher Artery Forceps, straight, 13 cm (5"), S
- 1 Probe with myrtle leaf, 13 cm (5")

Completo en caja de metal con bolsa de plástico y 2 bandejas perforadas para los instrumentos

Contenido:

- 1 Porta-aguja de Mathieu, 14 cm (5<sup>1</sup>/<sub>2</sub>"
- 1 Frasco con seda esterilizada para sutura, en alcohol
- 6 Agujas de sutura surtidas
- 1 Cajita para agujas, 65 x 42 mm, perforada
- 1 Pinza para agrafes de Michel
- 20 Agrafes de Michel, en su porta-agrafes
- 1 Mango de bisturi, con hoja intercambiable
- 3 Hojas intercambiables surtidas
- 1 Tijera, recta, roma/aguda, 13 cm (5")
- 1 Pinza de disección, 11,5 cm (4<sup>1</sup>/<sub>2</sub>"
- 1 Pinza de disección, con 1 x 2 dientes, 12 cm (4<sup>3</sup>/<sub>4</sub>"
- 1 Pinza para espinas de Hunter, 10,5 cm (4<sup>1</sup>/<sub>4</sub>"
- 1 Pinza hemostática de Kocher, 13 cm (5"), S.
- 1 Estilete abotonado, multiforme, 13 cm (5")

Astuccio tascabile con due supporti estraibili

Contenente:

- 1 Port aghi di Mathieu 14 cm (5<sup>1</sup>/<sub>2</sub>"
- 1 Set per sutura in flacone di vetro
- 6 aghi per sutura assortiti
- 1 scatola per aghi 65 x 24 perforata
- 1 pinza per sutura di Michel
- 20 Agrafe Michel ed porta agrafe
- 1 Manico da bisturi per lama intercambiabile
- 3 lame da bisturi intercambiabili
- 1 forbici rette alterne 13 cm (5")
- 1 pinze da dissezione
- 1 pinze da dissezione 1 x 2 denti
- 1 pinze di Hunter per schegge 10,5 cm (4<sup>1</sup>/<sub>4</sub>"
- 1 pinze emostatiche di Kocher 13 cm (5")
- 1 specillo bottonuto 13 cm (5")

Sterilisierzangen, Abfallzange, Sterilisierklammern  
 Sterilization Instruments, Waste Forceps, Safety pins  
 Instrumentos para la esterilización, Pinza para desechos, Cadres de estérilizacion,  
 Pinze per la sterilizzazione, Pinza per rifiuti, Spilloni p. sterilizzazione



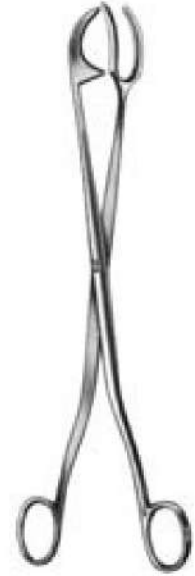
DAVIS  
 EV29102-16 16 cm, 6 1/4"  
 EV29102-20 20 cm, 8"  
 EV29102-24 24 cm, 9 1/2"



CHEATTLE  
 EV29110-27  
 27 cm, 10 1/2"



UNIVERSAL  
 EV29120-20 20 cm, 8"  
 EV29120-28 28 cm, 11"  
 EV29121-20  
 EV29121-28



ROGGE  
 EV29130-23  
 23 cm, 9"



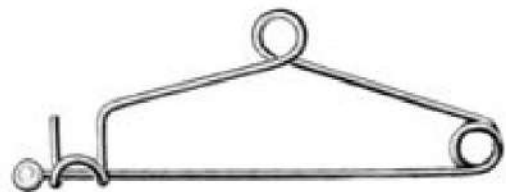
EV29140-20 20 cm, 8"  
 EV29140-30 30 cm, 11 3/4"



SAUERBRUCH  
 EV29145-55  
 55 cm, 21.7"

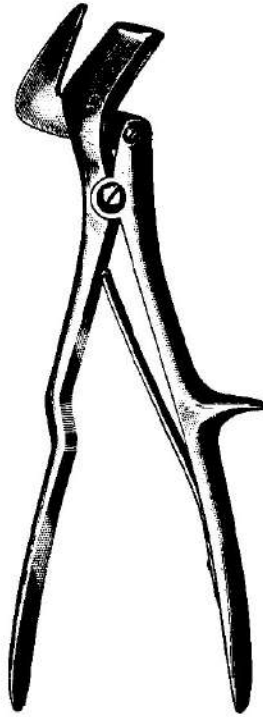


BUNT EV29150-12  
 12 cm, 4 3/4"

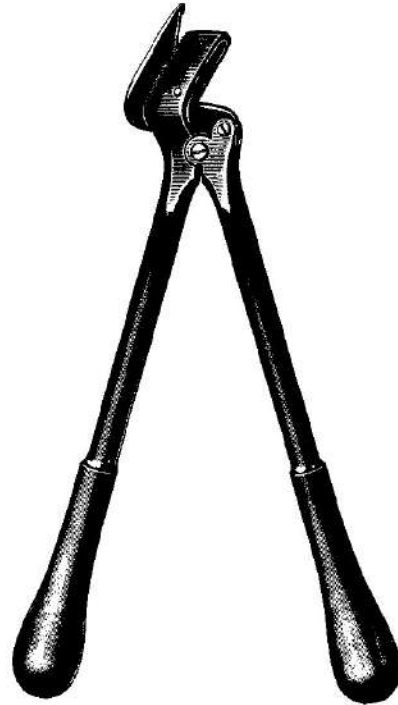


MAYO  
 EV29152-14 14 cm, 5 1/2"

Gippscheren  
 Plaster of Paris Shears  
 Cizallas para vendajes enyesados  
 Cesioie per gessi



STILLE  
 EV31101-24 24 cm, 9 1/2"

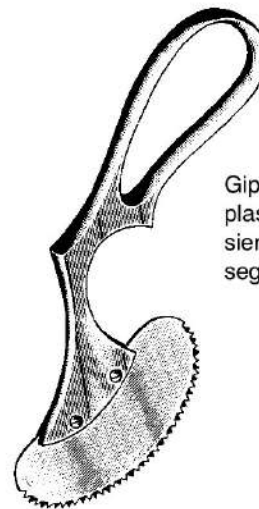


STILLE  
 EV31103-23 23 cm, 9"  
 EV31103-26 26 cm, 10 1/4"  
 EV31103-37 37 cm, 14 1/2"



Gipsmesser  
 plaster knife  
 cuchillo para vendajes enyesados  
 coltello da gesso

WIGMORE  
 EV31120-19 19 cm, 7 1/2"



Gipssäge  
 plaster saw  
 sierra para vendajes enyesados  
 sega da gesso

ENGEL  
 EV31130-14 16 cm, 6 1/4"  
 verchromt, chrome plated

Autopsiesäge  
Autopsy saw  
Sierra para autopsia  
Sega per autopsia

Geräuschpegel: 52 - 77 db (A)  
Noise level: 52 - 77 db (A)  
Nivel de ruido del aparato sólo: 52 - 77 db (A)  
Livello acustico dello strumento solo: 52 - 77 db (A)

6500-24000 Schwingungen pro Minute  
6500-24000 oscillations per minute  
6500-24000 oscilaciones por minuto  
6500-24000 oscillazioni al minute

EN 60601-1, EN 60601-1-2, IEC 60601-1, IEC 60601-1-2



EV31201-01 120 Volt, 500 Watt, 1,5 kg

EV31201-02 230 Volt, 500 Watt, 1,5 kg

**EV31201-01 + EV31201-02 inklusive, inclusive, inclusive, inclusive:**

1x EV31210-50 Ø 50mm Sägeblatt, saw blade, hoja de repuesto, lama per sega

1x EV31210-65 Ø 65mm Sägeblatt, saw blade, hoja de repuesto, lama per sega

1x EV31204-01 Ø 50/65mm Segment-Sägeblatt, segment saw blade, hoja de repuesto para segmento, lama per sega a segmento

1x EV31202-16 Inbusschlüssel T-Griff, alan key with T-handle, llave hexagonal con mango de T, chiave esagonale con manico a T

1x EV31200-95 Spritze, gefüllt mit Fett, injection filled with fat, jeringa rellena con grasa, siringa colmata con grassa

1x EV31212-02 Paar Gabelschlüssel, pair flat wrench, pareja llave de boca, paio chiave a bocca, 11mm



Zubehör für Autopsiesäge EV31201-02 und EV31201-01 siehe Seite 230/14 - 230/18 Accessories for Autopsy saw EV31201-02 and EV31201-01 please see page 230/14 - 230/18 Accesorios para sierra para autopsia EV31201-02y

EV31201-01 vea la página 230/14 - 230/18

Accessorio per sega per autopsia 31201-02 e 31201-01 vedi pagina 230/14 - 230/18

|            |           |   |
|------------|-----------|---|
| EV31210-45 | Ø 45mm    | Sägeblatt, saw blade, hoja de repuesto, lama per sega   |
| EV31210-50 | Ø 50mm    | Sägeblatt, saw blade, hoja de repuesto, lama per sega   |
| EV31210-65 | Ø 65mm    | Sägeblatt, saw blade, hoja de repuesto, lama per sega   |
| EV31204-01 | Ø 50/65mm | Segment-Sägeblatt, segment saw blade, hoja de repuesto para segmento, lama per sega a segmento                  |
| EV31204-03 | Ø 65/65mm | Segment-Sägeblatt, segment saw blade, hoja de repuesto para segmento, lama per sega a segmento                  |
| EV31205-08 | 8mm       | Tiefen-Sägeblatt, deep cutting saw, hoja de sierra de profundidad, lama a taglio di profondità                  |
| EV31205-20 | 20mm      | Tiefen-Sägeblatt, deep cutting saw, hoja de sierra de profundidad, lama a taglio di profondità                  |
| EV31203-50 |           | Begrenzungsscheibe, limiting disc, disco de tope, disco eccentrico  |
| EV31202-16 |           | Inbusschlüssel T-Griff, alan key with T-handle, llave hexagonal con mango de T, chiave esagonale con manico a T |
| EV31200-95 |           | Spritze gefüllt mit Fett, injection filled with fat, jeringa rellena con grasa, siringa colmata con grassa      |
| EV31212-02 |           | 1 Paar Gabelschlüssel, pair flat wrench, pareja llave de boca, paio chiave a bocca, 11mm                        |

Autopsiesäge  
Autopsy saw  
Sierra para autopsia  
Sega per autopsia

Geräuschpegel: 52 - 77 db (A)  
Noise level: 52 - 77 db (A)  
Nivel de ruido del aparato sólo: 52 - 77 db (A)  
Livello acustico dello strumento solo: 52 - 77 db (A)

6500-24000 Schwingungen pro Minute  
6500-24000 oscillations per minute  
6500-24000 oscilaciones por minuto  
6500-24000 oscillazioni al minute

EN 60601-1, EN 60601-1-2, IEC 60601-1, IEC 60601-1-2



Dreikantschaft  
Three-jaw chuck  
Mandril de tres mordazas  
Mandrino con tre ganasce



EV31201-11 120 Volt, 500 Watt, 1,5 kg

EV31201-22 230 Volt, 500 Watt, 1,5 kg

**EV31201-11 + 31201-22 inklusive, inclusive, inclusive, inclusive:**

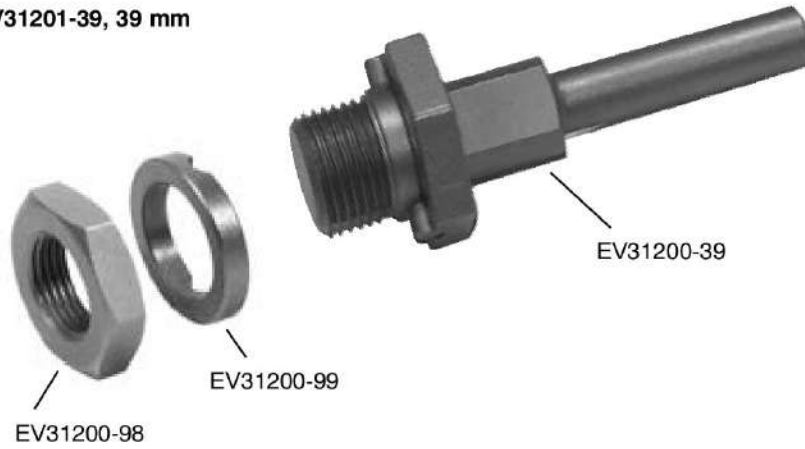
- |               |           |   |
|---------------|-----------|---|
| EV31201-39    | 39mm      | Schaft komplett, Arbor complete, Vastago completo, Asta completa 1x   |
| EV31210-50    | Ø 50mm    | Sägeblatt, saw blade, hoja de repuesto, lama per sega 1x  |
| EV31210-65    | Ø 65mm    | Sägeblatt, saw blade, hoja de repuesto, lama per sega   |
| 1x EV31204-01 | Ø 50/65mm | Segment-Sägeblatt, segment saw blade, hoja de repuesto para segmento, lama per sega a segmento                  |
| 1x EV31202-16 |           | Inbusschlüssel T-Griff, alan key with T-handle, llave hexagonal con mango de T, chiave esagonale con manico a T |
| 1x EV31200-95 |           | Spritze gefüllt mit Fett, injection filled with fat, jeringa rellena con grasa, siringa colmata con grassa      |
| 1x EV31202-14 |           | Paar Gabelschlüssel, pair flat wrench, pareja llave de boca, paio chiave a bocca, 14mm                          |

Zubehör für Autopsiesäge EV31201-22 und EV31201-11 siehe Seite 230/14 - 230/18 Accessories for Autopsy saw EV31201-22 and EV31201-11 please see page 230/14 - 230/18 Accesorios para sierra para autopsia EV31201-22 y EV31201-11 vea la página 230/14 - 230/18 Accessorio per sega per autopsia EV31201-22 e EV31201-11 vedi pagina 230/14 - 230/18

|            |           |   |
|------------|-----------|---|
| EV31210-45 | Ø 45mm    | Sägeblatt, saw blade, hoja de repuesto, lama per sega   |
| EV31210-50 | Ø 50mm    | Sägeblatt, saw blade, hoja de repuesto, lama per sega   |
| EV31210-65 | Ø 65mm    | Sägeblatt, saw blade, hoja de repuesto, lama per sega   |
| EV31204-01 | Ø 50/65mm | Segment-Sägeblatt, segment saw blade, hoja de repuesto para segmento, lama per sega a segmento                  |
| EV31204-03 | Ø 65/65mm | Segment-Sägeblatt, segment saw blade, hoja de repuesto para segmento, lama per sega a segmento                  |
| EV31205-08 | 8mm       | Tiefen-Sägeblatt, deep cutting saw, hoja de sierra de profundidad, lama a taglio di profondità                  |
| EV31205-20 | 20mm      | Tiefen-Sägeblatt, deep cutting saw, hoja de sierra de profundidad, lama a taglio di profondità                  |
| EV31203-50 |           | Begrenzungsscheibe, limiting disc, disco de tope, disco eccentrico  |
| EV31202-16 |           | Inbusschlüssel T-Griff, alan key with T-handle, llave hexagonal con mango de T, chiave esagonale con manico a T |
| EV31200-95 |           | Spritze gefüllt mit Fett, injection filled with fat, jeringa rellena con grasa, siringa colmata con grassa      |
| EV31202-14 |           | 1 Paar Gabelschlüssel, pair flat wrench, pareja llave de boca, paio chiave a bocca, 14mm                        |

Zubehör zur Autopsiesäge  
Accessories for Autopsy saw  
Accesorio para la sierra de autopsia  
Accessori per sega per autopsia

EV31201-39, 39 mm



EV31201-58, 58 mm



Zubehör zur Autopsiesäge  
Accessories for Autopsy saw  
Accesorio para la sierra de autopsia  
Accessori per sega per autopsia

**Set EV31203-10**



**Set EV31203-10:EV31201-39 + EV31210-65**

**Set EV31203-00:EV31201-39 + EV31210-50**

**Set EV31203-20:EV31201-58 + EV31210-50**

**Set EV31203-30:EV31201-58 + EV31210-65**

**Set EV31204-00**



**Set EV31204-00:EV31201-39 + EV31204-01**

**Set EV31204-10:EV31201-39 + EV31204-03**

**Set EV31204-20:EV31201-58 + EV31204-01**

**Set EV31204-30:EV31201-58 + EV31204-03**

Zubehör zur Autopsiesäge  
Accessories for Autopsy saw  
Accesorio para la sierra de autopsia  
Accessori per sega per autopsia

**Set EV31205-00**



**Set EV31205-00:**EV31201-39 + EV31205-20

**Set EV31206-00:**EV31201-39 + EV31205-08

**Set EV31206-10:**EV31201-58 + EV31205-08

**Set EV31205-10:**EV31201-58 + EV31205-20

**Set EV31210-10**

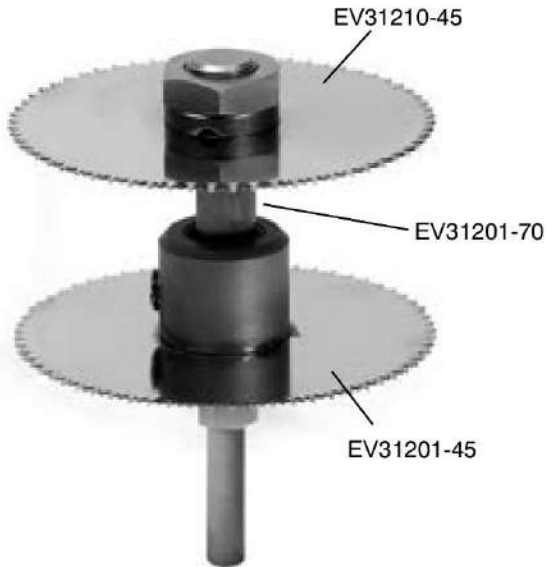


**Set EV31210-10:** EV31201-39 + 31210-65 + EV31203-50

**Set EV31210-00:** EV31201-58 + 31210-65 + EV31203-50

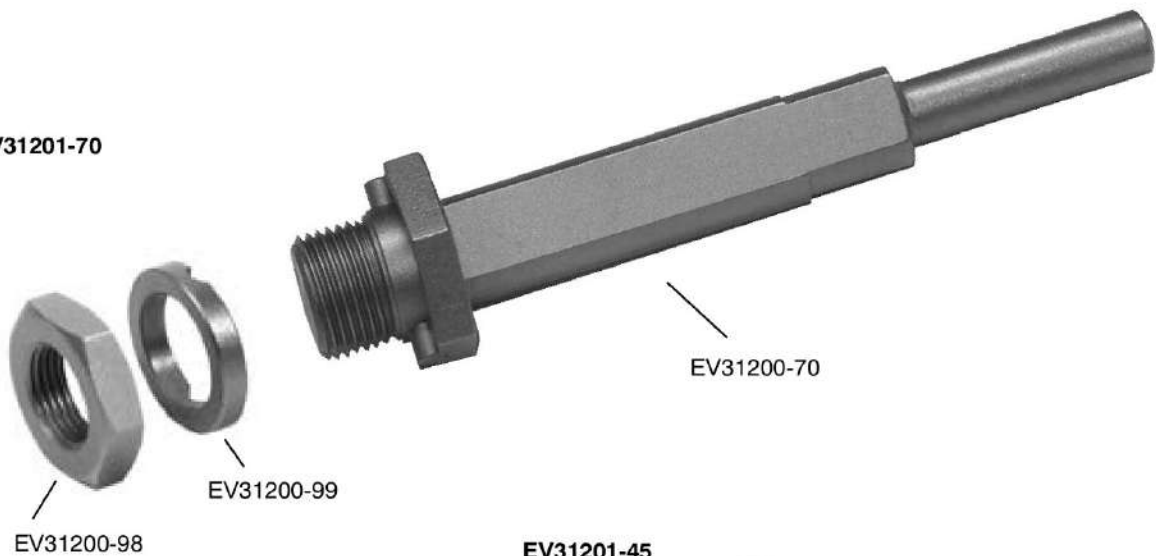
Zubehör zur Autopsiesäge  
Accessories for Autopsy saw  
Accesorio para la sierra de autopsia  
Accessori per sega per autopsia

**Set EV31202-00**

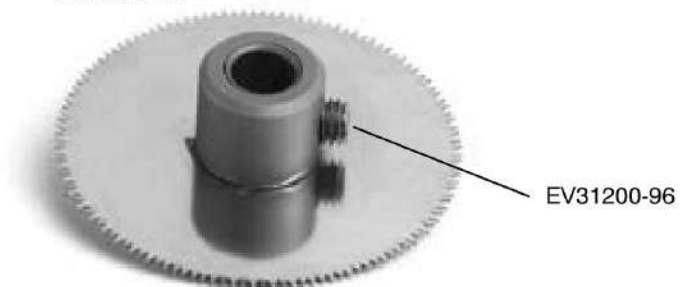


**Set EV31202-00:** EV31201-70 + EV31210-45 + EV31201-45

**EV31201-70**



**EV31201-45**



Zubehör für Autopsiesäge EV31201-22 und EV31201-11 siehe Seite 230/4 - 230/7  
 Accessories for Autopsy saw EV31201-22 and EV31201-11 please see page 230/4 - 230/7  
 Accesorios para sierra para autopsia EV31201-22 y EV31201-11 vea la página 230/4 - 230/7  
 Accessorio per sega per autopsia EV31201-22 e EV31201-11 vedi pagina 230/4 - 230/7

- EV31200-39 Schaft 39mm allein
- EV31201-39 Schaft 39mm komplett
- EV31203-00 Schaft 39mm komplett + Sägeblatt Ø 50mm
- EV31203-10 Schaft 39mm komplett + Sägeblatt Ø 65mm
- EV31204-00 Schaft 39mm komplett + Segmentsägeblatt 50/65mm
- EV31204-10 Schaft 39mm komplett + Segmentsägeblatt 65/65mm
- EV31210-10 Schaft 39mm komplett + Sägeblatt Ø 65mm + Begrenzungsscheibe
- EV31206-00 Schaft 39mm komplett + Tiefensägeblatt 8mm
- EV31205-00 Schaft 39mm komplett + Tiefensägeblatt 20mm
  
- EV31200-58 Schaft 58mm allein
- EV31201-58 Schaft 58mm komplett
- EV31203-20 Schaft 58mm komplett + Sägeblatt Ø 50mm
- EV31203-30 Schaft 58mm komplett + Sägeblatt Ø 65mm
- EV31204-20 Schaft 58mm komplett + Segmentsägeblatt 50/65mm
- EV31204-30 Schaft 58mm komplett + Segmentsägeblatt 65/65mm
- EV31210-00 Schaft 58mm komplett + Sägeblatt Ø 65mm + Begrenzungsscheibe
- EV31206-10 Schaft 58mm komplett + Tiefensägeblatt 8mm
- EV31205-10 Schaft 58mm komplett + Tiefensägeblatt 20mm
  
- EV31200-70 Schaft Doppelsäge allein
- EV31201-70 Schaft Doppelsäge komplett
- EV31202-00 Schaft Doppelsäge komplett + Sägeblatt Ø 45mm + verstellbares Sägeblatt Ø 45mm
  
- EV31201-45 verstellbares Sägeblatt Ø 45mm komplett
- EV31200-96 Inbusmadenschraube für verstellbares Sägeblatt Ø 45mm komplett
  
- EV31200-98 Mutter für Schaft
- EV31200-99 Sperring für Schaft

- EV31200-39 Arbor 39mm only
- EV31201-39 Arbor 39mm complete
- EV31203-00 Arbor 39mm complete + saw blade Ø 50mm
- EV31203-10 Arbor 39mm complete + saw blade Ø 65mm
- EV31204-00 Arbor 39mm complete + segment saw blade 50/65mm
- EV31204-10 Arbor 39mm complete + segment saw blade 65/65mm
- EV31210-10 Arbor 39mm complete + saw blade Ø 65mm + limiting disc
- EV31206-00 Arbor 39mm complete + deep cutting saw 8mm
- EV31205-00 Arbor 39mm complete + deep cutting saw 20mm
  
- EV31200-58 Arbor 58mm only
- EV31201-58 Arbor 58mm complete
- EV31203-20 Arbor 58mm complete + saw blade Ø 50mm
- EV31203-30 Arbor 58mm complete + saw blade Ø 65mm
- EV31204-20 Arbor 58mm complete + segment saw blade 50/65mm
- EV31204-30 Arbor 58mm complete + segment saw blade 65/65mm
- EV31210-00 Arbor 58mm complete + saw blade Ø 65mm + limiting disc
- EV31206-10 Arbor 58mm complete + deep cutting saw 8mm
- EV31205-10 Arbor 58mm complete + deep cutting saw 20mm
  
- EV31200-70 Double saw only
- EV31201-70 Double saw complete
- EV31202-00 Double saw complete + saw blade Ø 45mm + adjustable saw blade Ø 45mm
  
- EV31201-45 Adjustable saw blade Ø 45mm complete
- EV31200-96 Allen screw for adjustable saw blade Ø 45mm complete
  
- EV31200-98 Nut for arbor
- EV31200-99 Blocking ring for arbor



Zubehör für Autopsiesäge EV31201-22 und EV31201-11 siehe Seite 230/4 - 230/7  
 Accessories for Autopsy saw EV31201-22 and EV31201-11 please see page 230/4 - 230/7  
 Accesorios para sierra para autopsia EV31201-22 y EV31201-11 vea la página 230/4 - 230/7  
 Accessorio per sega per autopsia EV31201-22 e EV31201-11 vedi pagina 230/4 - 230/7

- EV31200-39 Vastago 39mm suelto  
 EV31201-39 Vastago 39mm completo  
 EV31203-00 Vastago 39mm completo + hoja de repuesto Ø 50mm  
 EV31203-10 Vastago 39mm completo + hoja de repuesto Ø 65mm  
 EV31204-00 Vastago 39mm completo + hoja de repuesto para segmento 50/65mm  
 EV31204-10 Vastago 39mm completo + hoja de repuesto para segmento 65/65mm  
 EV31210-10 Vastago 39mm completo + hoja de repuesto Ø 65mm + disco de tope  
 EV31206-00 Vastago 39mm completo + hoja de sierra de profundidad 8mm  
 EV31205-00 Vastago 39mm completo + hoja de sierra de profundidad 20mm
- EV31200-58 Vastago 58mm suelto  
 EV31201-58 Vastago 58mm completo  
 EV31203-20 Vastago 58mm completo + hoja de repuesto Ø 50mm  
 EV31203-30 Vastago 58mm completo + hoja de repuesto Ø 65mm  
 EV31204-20 Vastago 58mm completo + hoja de repuesto para segmento 50/65mm  
 EV31204-30 Vastago 58mm completo + hoja de repuesto para segmento 65/65mm  
 EV31210-00 Vastago 58mm completo + hoja de repuesto Ø 65mm + disco de tope  
 EV31206-10 Vastago 58mm completo + hoja de sierra de profundidad 8mm  
 EV31205-10 Vastago 58mm completo + hoja de sierra de profundidad 20mm
- EV31200-70 Doble sierra suelta  
 EV31201-70 Doble sierra completa  
 EV31202-00 Doble sierra completa + hoja de repuesto Ø 45mm + hoja de sierra ajustable Ø 45mm
- EV31201-45 hoja de sierra ajustable Ø 45mm completa  
 EV31200-96 tornillo con hembra hexagonal para hoja de sierra ajustable Ø 45mm completa
- EV31200-98 tuerca para vastago  
 EV31200-99 anillo de recambio para vastago
- EV31200-39 Asta 39mm sola  
 EV31201-39 Asta 39mm completa  
 EV31203-00 Asta 39mm completa + lama per sega Ø 50mm  
 EV31203-10 Asta 39mm completa + lama per sega Ø 65mm  
 EV31204-00 Asta 39mm completa + lama per sega a segmento 50/65mm  
 EV31204-10 Asta 39mm completa + lama per sega a segmento 65/65mm  
 EV31210-10 Asta 39mm completa + lama per sega Ø 65mm + disco eccentrico  
 EV31206-00 Asta 39mm completa + lama a taglio di profondità 8mm  
 EV31205-00 Asta 39mm completa + lama a taglio di profondità 20mm
- EV31200-58 Asta 58mm sola  
 EV31201-58 Asta 58mm completa  
 EV31203-20 Asta 58mm completa + lama per sega Ø 50mm  
 EV31203-30 Asta 58mm completa + lama per sega Ø 65mm  
 EV31204-20 Asta 58mm completa + lama per sega a segmento 50/65mm  
 EV31204-30 Asta 58mm completa + lama per sega a segmento 65/65mm  
 EV31210-00 Asta 58mm completa + lama per sega Ø 65mm + disco eccentrico  
 EV31206-10 Asta 58mm completa + lama a taglio di profondità 8mm  
 EV31205-10 Asta 58mm completa + lama a taglio di profondità 20mm
- EV31200-70 Seg a doppia lama sola  
 EV31201-70 Seg a doppia lama completa  
 EV31202-00 Seg a doppia lama completa + lama per sega Ø 45mm + lame per sega regolabile Ø 45mm
- EV31201-45 lame per sega regolabile Ø 45mm completa  
 EV31200-96 tornillo con hembra hexagonal para hoja de sierra ajustable Ø 45mm completa
- EV31200-98 brugola per asta  
 EV31200-99 anello di ricambio per asta

Oszillierende Gipssäge  
Oscillating Plaster Saw  
Sierra oscilante p. vendajes enyesados  
Sega oscillante per gessi

Geräuschpegel: 52 - 77 db (A)  
Noise level: 52 - 77 db (A)  
Nivel de ruido del aparato sólo: 52 - 77 db (A)  
Livello acustico dello strumento solo: 52 - 77 db (A)

6500-24000 Schwingungen pro Minute  
6500-24000 oscillations per minute  
6500-24000 oscilaciones por minuto  
6500-24000 oscillazioni al minuto

EN 60601-1, EN 60601-1-2, IEC 60601-1, IEC 60601-1-2



EV31210-21 120 Volt, 500 Watt, 1,5 kg

EV31210-22 230 Volt, 500 Watt, 1,5 kg

**EV31210-21 + EV31210-22 inklusive, inclusive, inclusive, inclusive:**

1x EV31210-50 Ø 50mm Sägeblatt, saw blade, hoja de repuesto, lama per sega

1x EV31210-65 Ø 65mm Sägeblatt, saw blade, hoja de repuesto, lama per sega

1x EV31212-02 Paar Gabelschlüssel, pair flat wrench, pareja llave de boca, paio chiave a bocca, 11mm

Zubehör für oszillierende Gipsäge EV31210-22 und EV31210-21 siehe Seite 230/14 - 230/18 Accessories for oscillating plaster saw EV31210-22 and EV31210-21 please see page 230/14 - 230/18 Accesorios p. sierra oscilante p. vendajes enyesados EV31210-22 y EV31210-21 vea la página 230/14 - 230/18 Accessorio per sega oscillante per gessi EV31210-22 e EV31210-21 vedi pagina 230/14 - 230/18

EV31212-02 1 Paar Gabelschlüssel, pair flat wrench, pareja llave de boca, paio chiave a bocca, 11mm  
 EV31210-30 Koffer, case, maleta, valigia

**Naturgipsverbände / bandage / vendajes enyesados / bandaggio in gesso**

EV31210-45 Ø 45mm Sägeblatt, saw blade, hoja de repuesto, lama per sega  
 EV31210-50 Ø 50mm Sägeblatt, saw blade, hoja de repuesto, lama per sega  
 EV31210-65 Ø 65mm Sägeblatt, saw blade, hoja de repuesto, lama per sega  
 EV31204-01 Ø 50/65mm Segment-Sägeblatt, segment saw blade, hoja de repuesto para segmento, lama per sega a segmento  
 EV31204-03 Ø 65/65mm Segment-Sägeblatt, segment saw blade, hoja de repuesto para segmento, lama per sega a segment  
 EV31205-08 8mm Tiefen-Sägeblatt, deep cutting saw, hoja de sierra de profundidad, lama a taglio di profondità  
 EV31205-20 20mm Tiefen-Sägeblatt, deep cutting saw, hoja de sierra de profundidad, lama a taglio di profondità

**synthetische Hartverbände / synthetic bandage / vendajes sinteticos / bandaggio sintetico**

EV31211-45 Ø 45mm Sägeblatt, saw blade, hoja de repuesto, lama per sega  
 EV31211-50 Ø 50mm Sägeblatt, saw blade, hoja de repuesto, lama per sega  
 EV31211-65 Ø 65mm Sägeblatt, saw blade, hoja de repuesto, lama per sega  
 EV31204-02 Ø 50/65mm Segment-Sägeblatt, segment saw blade, hoja de repuesto para segmento, lama per sega a segmento  
 EV31204-04 Ø 65/65mm Segment-Sägeblatt, segment saw blade, hoja de repuesto para segmento, lama per sega a segment  
 EV31205-09 8mm Tiefen-Sägeblatt, deep cutting saw, hoja de sierra de profundidad, lama a taglio di profondità  
 EV31205-21 20mm Tiefen-Sägeblatt, deep cutting saw, hoja de sierra de profundidad, lama a taglio di profondità

**PTFE synthetische Hartverbände / PTFE synthetic bandage / PTFE vendajes sinteticos / PTFE bandaggio sintetico**

EV31212-50 Ø 50mm Sägeblatt, saw blade, hoja de repuesto, lama per sega  
 EV31212-65 Ø 65mm Sägeblatt, saw blade, hoja de repuesto, lama per sega

**Naturgipsverbände und synthetische Hartverbände / Bandage and synthetic bandage / Vendajes enyesados y vendajes sinteticos / Bandaggio in gesso e bandaggio sintetico**

EV31203-50 Begrenzungsscheibe, limiting disc, disco de tope, disco eccentrico

Oszillierende Gipssäge  
Oscillating Plaster Saw  
Sierra oscilante p. vendajes enyesados  
Sega oscillante per gessi

Geräuschpegel: 52 - 77 db (A)  
Noise level: 52 - 77 db (A)  
Nivel de ruido del aparato sólo: 52 - 77 db (A)  
Livello acustico dello strumento solo: 52 - 77 db (A)

10000-19000 Schwingungen pro Minute  
10000-19000 oscillations per minute  
10000-19000 oscilaciones por minuto  
10000-19000 oscillazioni al minute

EN 60601-1, EN 60601-1-2, IEC 60601-1, IEC 60601-1-2



**Blue Power**

EV31220-21 120 Volt, 210 Watt, 1,25 kg

EV31220-22 230 Volt, 210 Watt, 1,25 kg

**31220-21 + 31220-22 inklusive, inclusive, inclusive, inclusive:**

1x EV31210-50 Ø 50mm Sägeblatt, saw blade, hoja de repuesto, lama per sega

1x EV31210-65 Ø 65mm Sägeblatt, saw blade, hoja de repuesto, lama per sega

1x EV31212-02 Paar Gabelschlüssel, pair flat wrench, pareja llave de boca, paio chiave a bocca, 11mm

Zubehör für oszillierende Gipsäge EV31220-22 und EV31220-21 siehe Seite 231/2 Accessories for oscillating plaster saw EV31220-22 and EV31220-21 please see page 231/2 Accesorios p. sierra oscilante p. vendajes enyesados EV31220-22 y EV31220-21 vea la página 231/2 Accessorio per sega oscillante per gessi EV31220-22 e EV31220-21 vedi pagina 231/2

- EV3121202 1 Paar Gabelschlüssel, pair flat wrench, pareja llave de boca, paio chiave a bocca, 11mm  
 EV31210-30 Koffer, case, maleta, valigia  
 EV31220-99 Filtervlies, woven filter, filtro de vellón, filtro vello  
 10 Stück, 10 pieces, 10 piezas, 10 pezzi

**Naturgipsverbände / bandage / vendajes enyesados / bandaggio in gesso**

- EV31210-45 Ø 45mm Sägeblatt, saw blade, hoja de repuesto, lama per sega  
 EV31210-50 Ø 50mm Sägeblatt, saw blade, hoja de repuesto, lama per sega  
 EV31210-65 Ø 65mm Sägeblatt, saw blade, hoja de repuesto, lama per sega  
 EV31204-01 Ø 50/65mm Segment-Sägeblatt, segment saw blade, hoja de repuesto para segmento, lama per sega a segmento  
 EV31204-03 Ø 65/65mm Segment-Sägeblatt, segment saw blade, hoja de repuesto para segmento, lama per sega a segment  
 EV31205-08 8mm Tiefen-Sägeblatt, deep cutting saw, hoja de sierra de profundidad, lama a taglio di profondità  
 EV31205-20 20mm Tiefen-Sägeblatt, deep cutting saw, hoja de sierra de profundidad, lama a taglio di profondità

**synthetische Hartverbände / synthetic bandage / vendajes sinteticos / bandaggio sintetico**

- EV31211-45 Ø 45mm Sägeblatt, saw blade, hoja de repuesto, lama per sega  
 EV31211-50 Ø 50mm Sägeblatt, saw blade, hoja de repuesto, lama per sega  
 EV31211-65 Ø 65mm Sägeblatt, saw blade, hoja de repuesto, lama per sega  
 EV31204-02 Ø 50/65mm Segment-Sägeblatt, segment saw blade, hoja de repuesto para segmento, lama per sega a segmento  
 EV31204-04 Ø 65/65mm Segment-Sägeblatt, segment saw blade, hoja de repuesto para segmento, lama per sega a segment  
 EV31205-09 8mm Tiefen-Sägeblatt, deep cutting saw, hoja de sierra de profundidad, lama a taglio di profondità  
 EV31205-21 20mm Tiefen-Sägeblatt, deep cutting saw, hoja de sierra de profundidad, lama a taglio di profondità

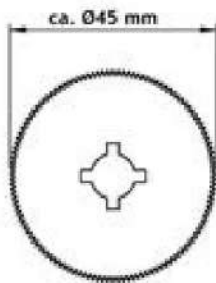
**PTFE synthetische Hartverbände / PTFE synthetic bandage / PTFE vendajes sinteticos / PTFE bandaggio sintetico**

- EV31212-50 Ø 50mm Sägeblatt, saw blade, hoja de repuesto, lama per sega  
 EV31212-65 Ø 65mm Sägeblatt, saw blade, hoja de repuesto, lama per sega

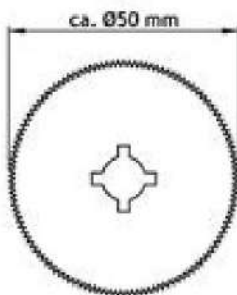
**Naturgipsverbände und synthetische Hartverbände / Bandage and synthetic bandage / Vendajes enyesados y vendajes sinteticos / Bandaggio in gesso e bandaggio sintetico**

- EV31203-50 Begrenzungsscheibe, limiting disc, disco de tope, disco eccentrico

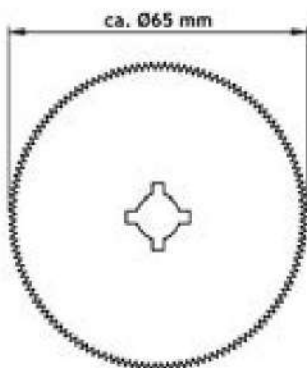
Sägeblätter  
Saw blades  
Hojas de repuesto  
Lame per sega



EV31210-45  
EV31211-45



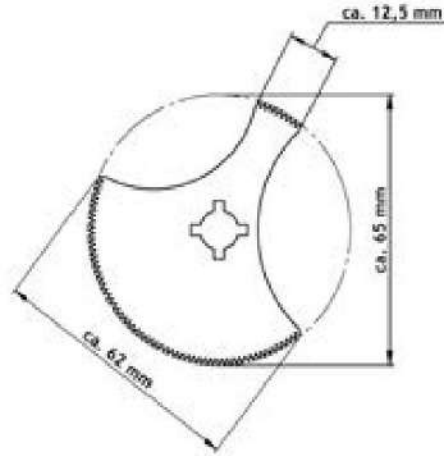
EV31210-50  
EV31211-50  
EV31212-50



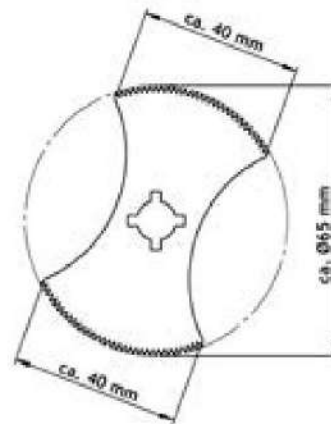
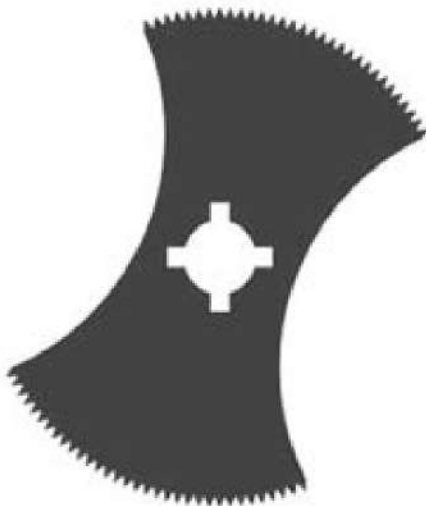
EV31210-65  
EV31211-65  
EV31212-65



Segment-Sägeblätter  
 Segment saw blades  
 Hojas de repuesto para segmento,  
 Lame per sega a segment



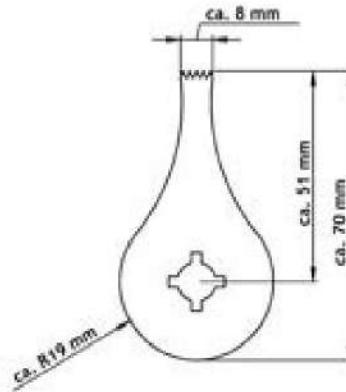
EV31204-01    Ø 50/65mm  
 EV31204-02    Ø 50/65mm



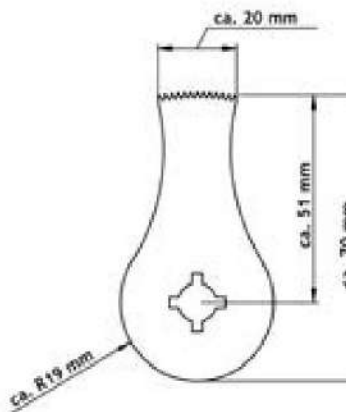
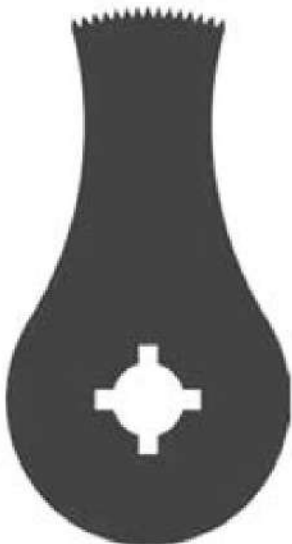
EV31204-03    Ø 65/65mm  
 EV31204-04    Ø 65/65mm



Tiefen-Sägeblätter  
depp cutting saw  
Hojas de sierra de profundidad,  
Lame a taglio di profondità



EV31205-08 8mm  
EV31205-09 8mm



EV31205-20 20mm  
EV31205-21 20mm

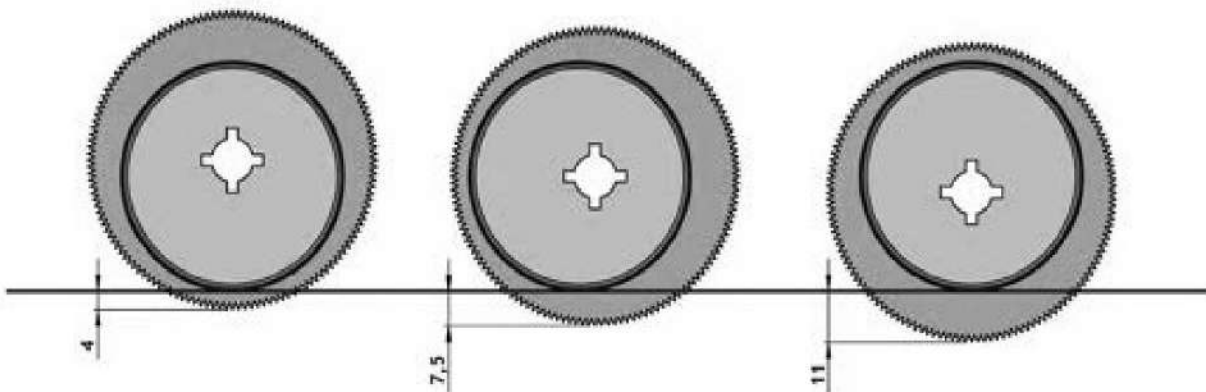


Sägeblätter  
Saw blades  
Hojas de repuesto  
Lame per sega



EV31203-50

Begrenzungsscheibe  
Limiting disc  
Disco de tope  
Disco eccentrico



EV31203-50  
für Sägeblatt mit Ø 65mm  
for Saw blade with Ø 65mm  
para hoja de sierra Ø 65mm  
per lama di sega Ø 65mm

EV31210-65  
EV31204-01  
EV31204-03  
EV31211-65  
EV31204-02  
EV31204-04  
EV31212-65

Zubehör  
Accessories  
Accessorio  
Accessori



EV31200-95



EV31202-16



EV31210-30



EV31212-02, 11 mm  
EV31202-14, 14 mm



EV31220-99  
10 Stück  
10 pieces  
10 piezas  
10 pezzi

Absauganlage und Wagen ohne Gipssäge  
 Hoover and carriage without plaster saw  
 Aspirador y careta sin sierra  
 Aspirazione e carello senza sega

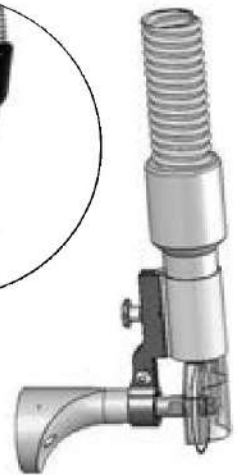
EV31252-11 120 Volt, 500 - 1250 Watt (1250 PT), 19 kg

EV31252-22 230 Volt, 500 - 1200 Watt (1450 PT), 19 kg

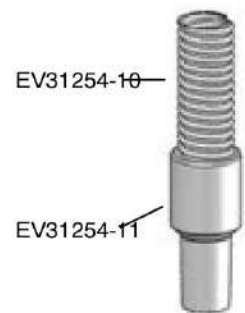


EV31254-10

EV31253-00 230 Volt  
 EV31253-11 120 Volt

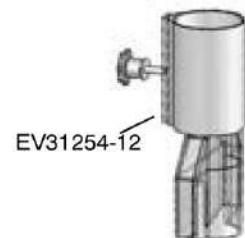


Aufgebaute Einheit  
 Set-up unit



EV31254-10

EV31254-11



EV31254-12

- EV31253-00 230 Volt, Staubsauger, Hoover, aspirador, aspirapolvere
- EV31253-11 120 Volt, Staubsauger, Hoover, aspirador, aspirapolvere
- EV31254-10 Saugschlauch 3,3 Meter, schwarz, suction hose 3,3 meter, black,  
manguera de aspiracion 3,3 metros, negra, tubo di aspirazione 3,3 metri, nera
- EV31254-11 Saugdüse schwarz, suction nozzle black, boquilla aspirante negra, ugello aspirante nero
- EV31254-12 Saughaube kpl., suction cover cpl., cofia de aspiracion cpl., cuffia di aspirazione cpl.
- EV31250-10 Set Filtertüten, set filter paper, set de filtros, set di filtri:  
1x EV31250-15  
6x EV31250-12  
6x EV31250-14

EV31250-12



Staubbeutel, Ather, antera, antera

EV31250-13



Motorfilter, motor filter, filtro para motor, filtro per motore

EV31250-14



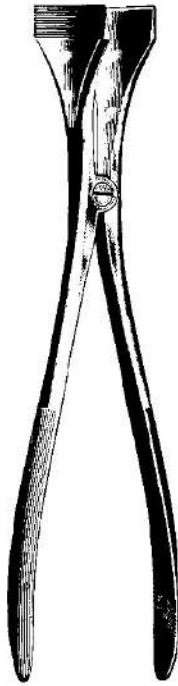
Duftstick, flavor stick, stick de aroma, stick di effluvio

EV31250-15

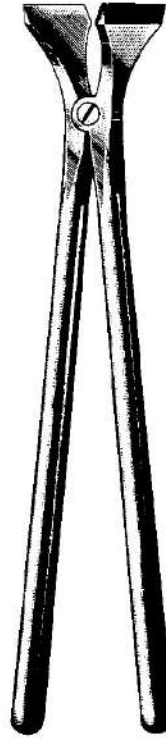


HEPA-Filter, HEPA-Filter, filtro HEPA, filtro HEPA,

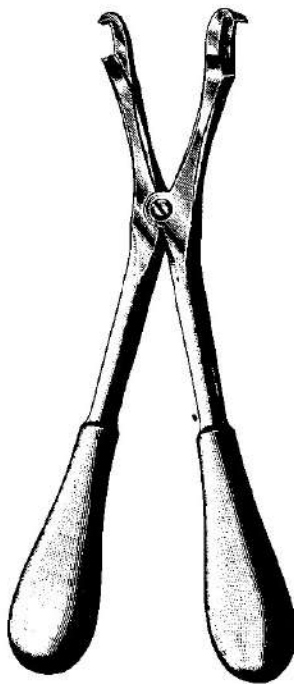
Gipsspreizer  
Plaster Cast Instruments  
Instrumentos para vendajes enyesados  
Allargagessi



HENNIG  
EV31350-28 28 cm, 11"



BEESON  
EV31360-30 30 cm, 11 <sup>3</sup>/<sub>4</sub>"



HAGLUND-STILLE  
EV31362-28 28 cm, 11"



ELGEN  
EV31366-23 23 cm, 9"

Gipsmesser, Gipsabreißzangen  
Plaster Cast Instruments, Knives  
Instrumentos para vendajes enyesados, Cuchillos  
Allargagessi, Coltelli per Gessi, Strappagessi



HOPKINS  
EV31370-20  
20 cm, 8"



ESMARCH  
EV31380-18  
18 cm, 7"



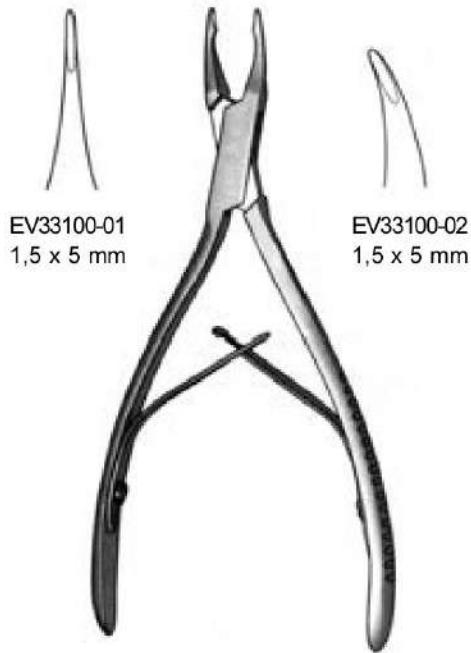
REINER  
EV31390-18  
18 cm, 7"



WOLFF  
EV31395-18  
18 cm, 7"



WOLFF  
EV31397-24  
24 cm, 9 1/2"



EV33100-01  
 1,5 x 5 mm



EV33100-02  
 1,5 x 5 mm

MICRO FRIEDMAN  
 14 cm, 5 1/2"



2 mm

FRIEDMAN Mini  
 EV33101-12 12 cm, 4 3/4"

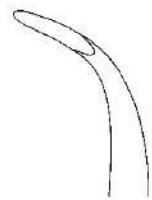


3,5 mm

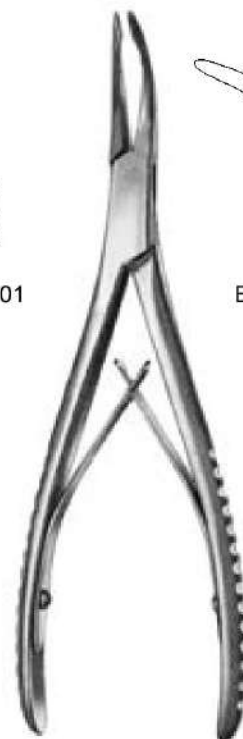
FRIEDMAN  
 EV33101-14 14 cm, 5 1/2"



EV33102-01  
 2 mm



EV33102-02  
 2 mm

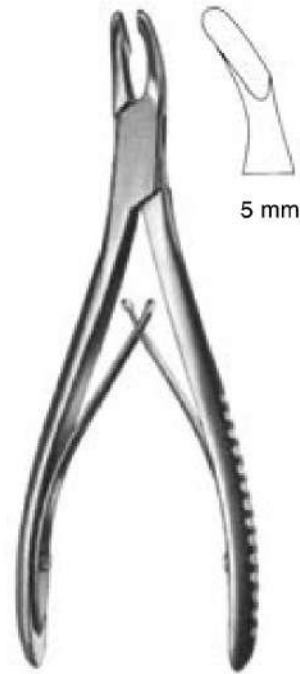


STELLBRINK  
 17 cm, 6 3/4"

Hohlmeißelzangen  
Bone Rongeurs  
Pinzas-gubias  
Pinze sgorbie



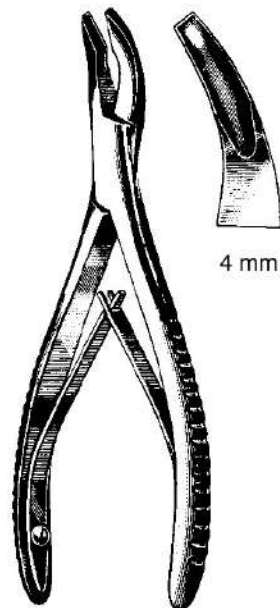
CLEVELAND EV33103-14  
14 cm, 5 1/2"



CLEVELAND  
EV33105-17 17 cm, 6 3/4"



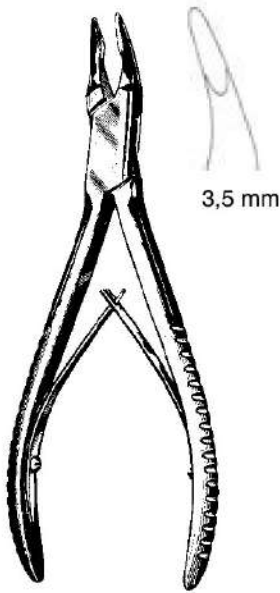
MEAD  
EV33107-16 16,5 cm, 6 1/2"



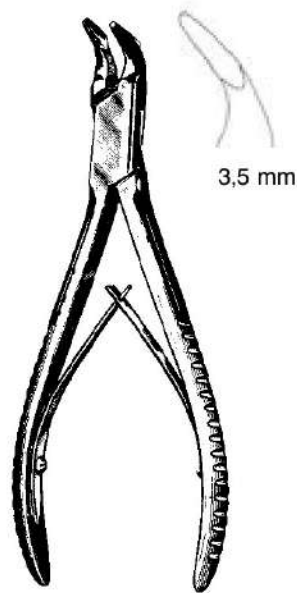
MEAD  
EV33109-16 16,5 cm, 6 1/2"



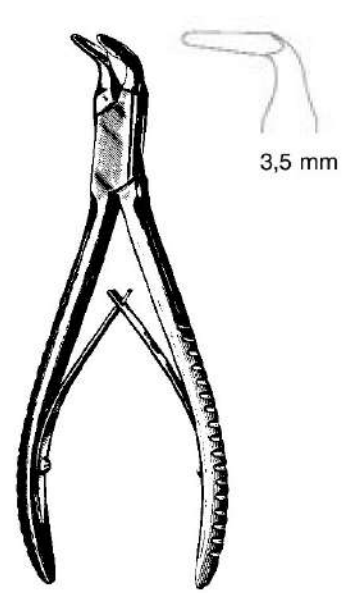
Hohlmeißelzangen  
 Bone Rongeurs  
 Pinzas-gubias  
 Pinze scorbie



BLUMENTHAL  
 EV33115-15  
 15,5 cm, 6"



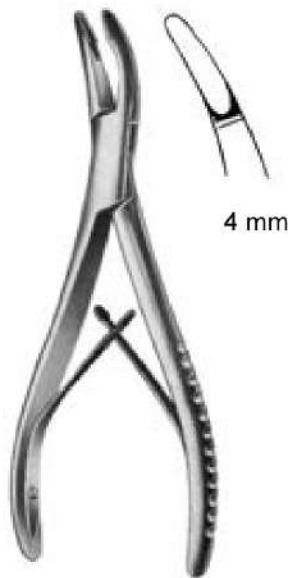
BLUMENTHAL  
 EV33117-15  
 15,5 cm, 6"



BLUMENTHAL  
 EV33119-15  
 15,5 cm, 6"



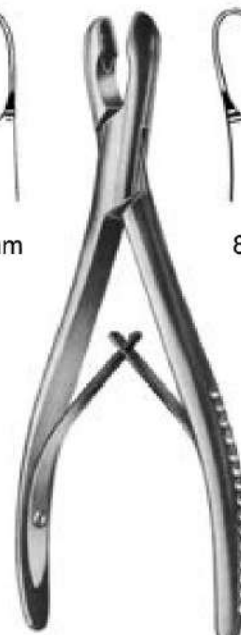
LUER  
 EV33131-15  
 15 cm, 5.9"



LUER  
 EV33133-15  
 15 cm, 5.9"



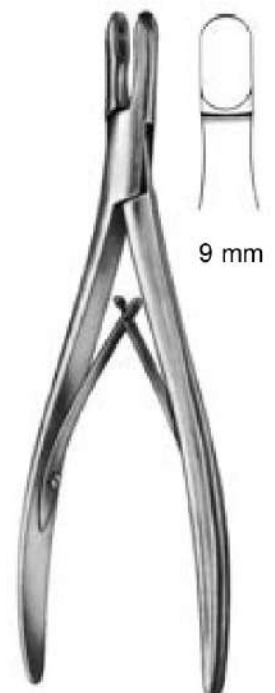
8 mm



LUER  
 EV33136-17 EV33137-17  
 17 cm, 6 3/4"



8 mm

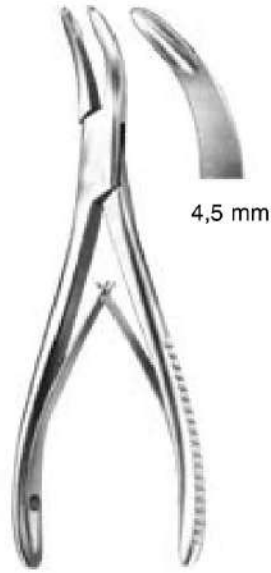


ADSON  
 EV33142-20 EV33143-20  
 20 cm, 7.9"

Hohlmeißelzangen  
Bone Rongeurs  
Pinzas-gubias  
Pinze sgorbie



OLIVECRONA  
EV33147-20  
20 cm, 7.9"



BANE-HARTMANN  
EV33148-18 17.5  
cm, 7"



LEMPERT  
EV33150-16 EV33151-16  
16 cm, 6 1/4"



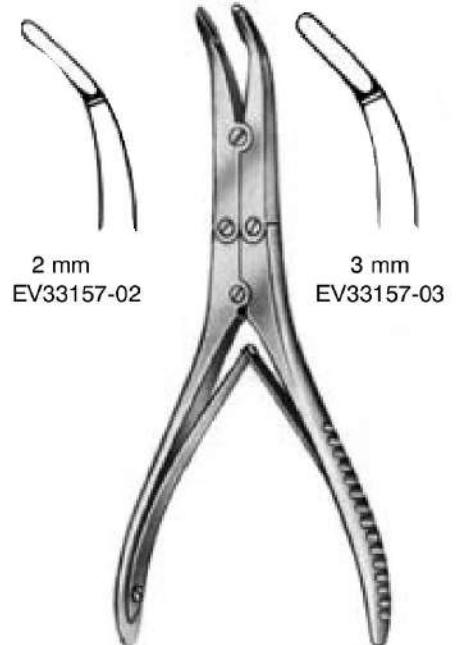
JANZEN  
17 cm, 6 3/4"



LEMPERT  
EV33154-18 EV33155-18  
18.5 cm, 7 1/4"

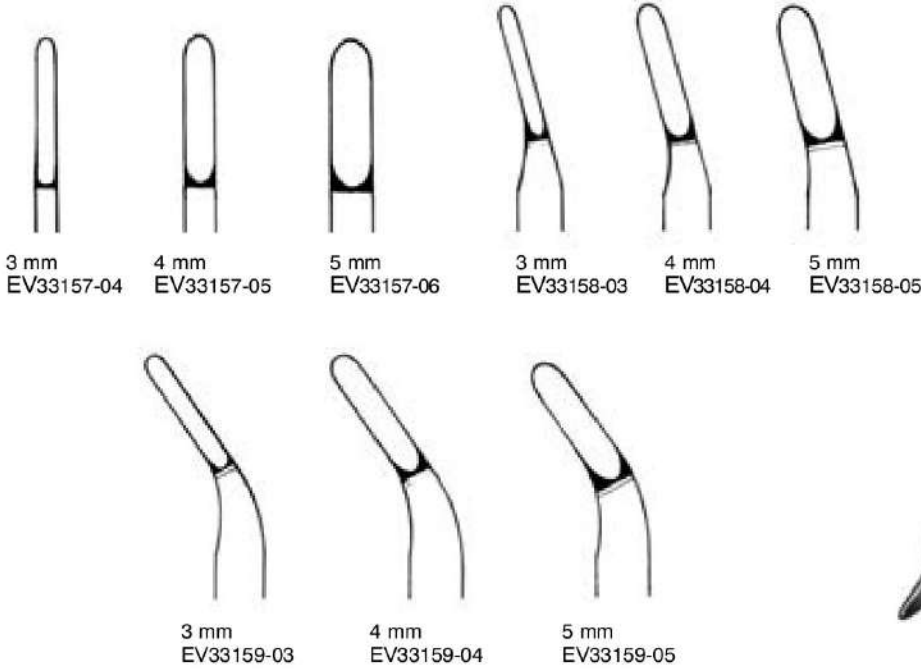


BEYER  
EV33156-18  
18 cm, 7"

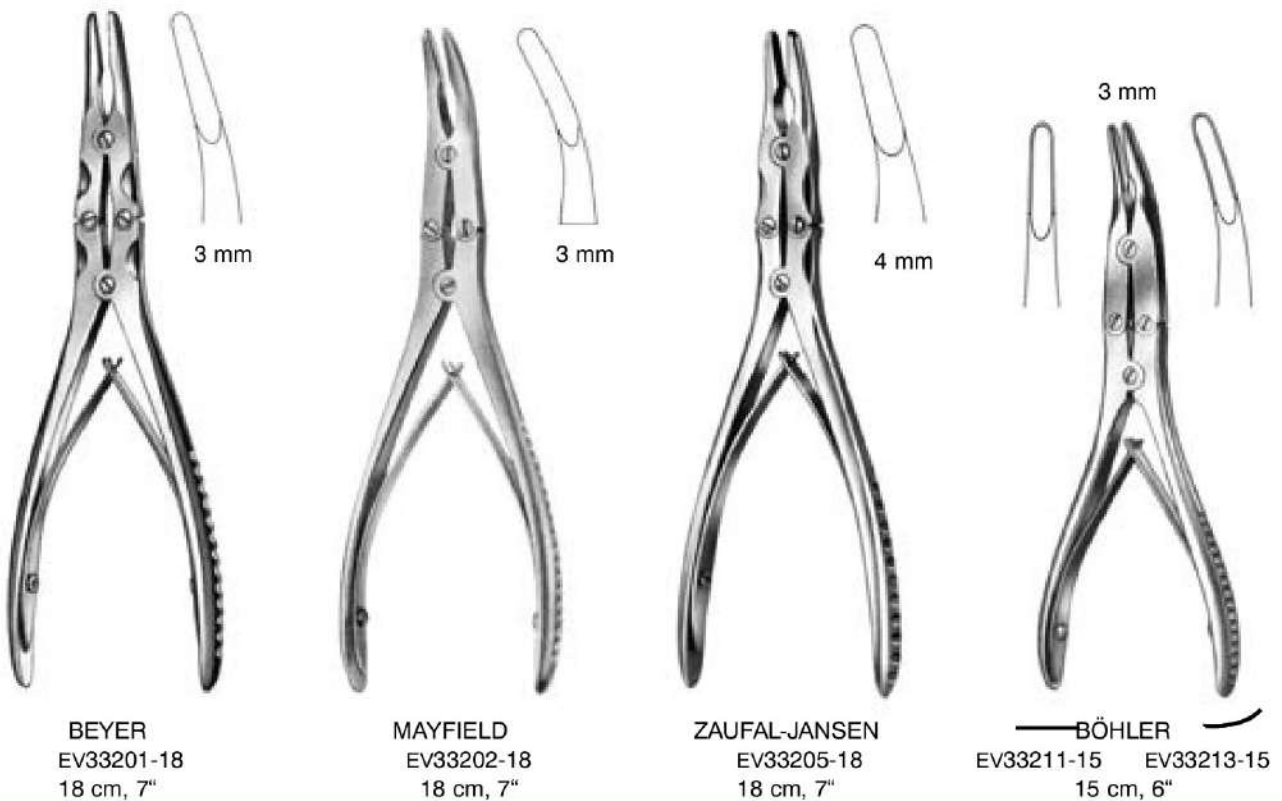


KLEINERT-KUTZ  
15 cm, 6"

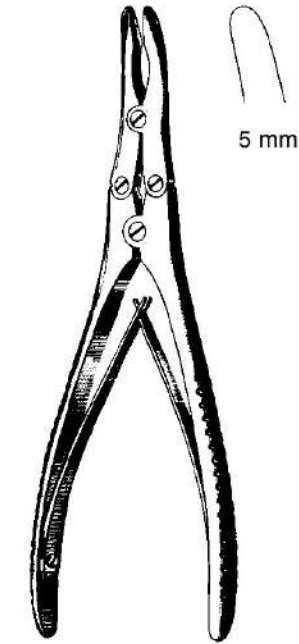
Hohlmeißelzangen  
 Bone Rongeurs  
 Pinzas-gubias  
 Pinze sgorbie



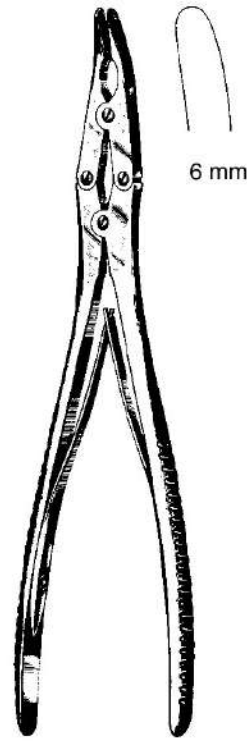
SMITH-PETERSEN  
 24 cm, 9 1/2"



Hohlmeißelzangen  
Bone Rongeurs  
Pinzas-gubias  
Pinze sgorbie



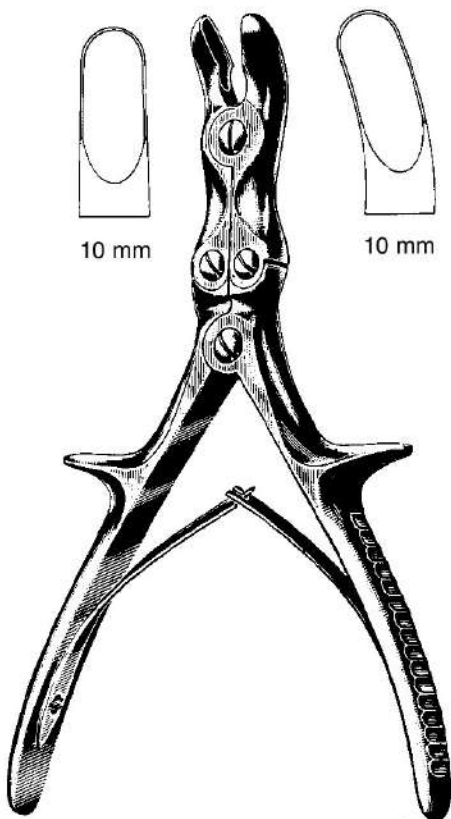
RUSKIN  
EV33216-18  
EV33217-18 18 cm, 7"



RUSKIN  
EV33219-23 23 cm, 9"



MARQUARDT  
EV33220-20 20 cm, 8"



STILLE-LUER  
EV33230-22 22 cm, 8 3/4" EV33231-22  
EV33230-26 26 cm, 10 1/4" EV33231-26

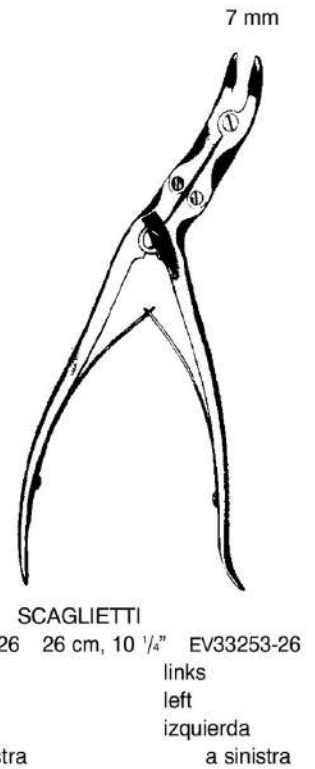
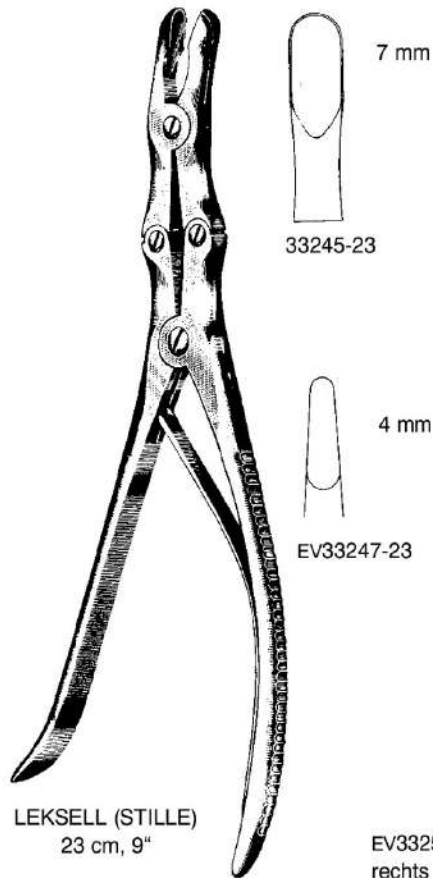
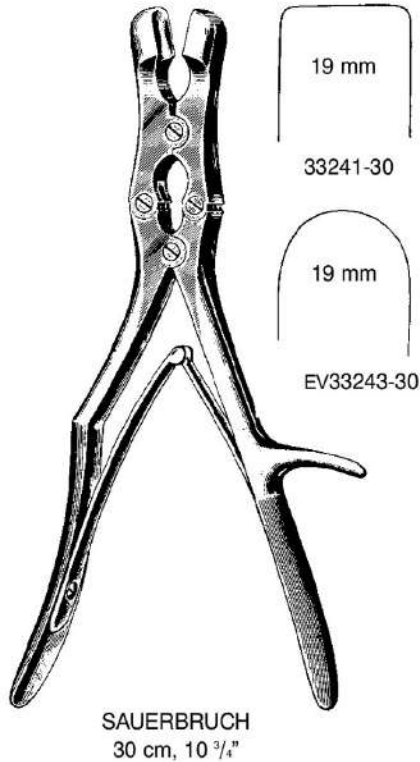


STILLE-LUER  
EV33235-23  
23 cm, 9"

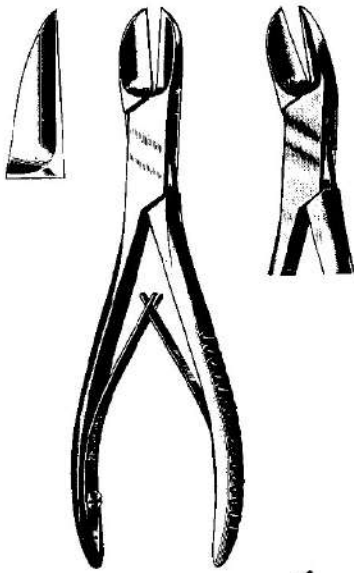


STILLE-RUSKIN  
EV33237-23  
23 cm, 9"

Hohlmeißelzangen  
 Bone Rongeurs  
 Pinzas-gubias  
 Pinze sgorbie



Knochensplitterzangen  
 Bone Cutting Forceps  
 Pinzas cortantes para huesos  
 Cesoie per ossa



**LISTON**

- |            |               |            |
|------------|---------------|------------|
| EV33274-14 | 14 cm, 5 1/2" | EV33275-14 |
| EV33274-17 | 17 cm, 6 3/4" | EV33275-17 |
| EV33274-19 | 19 cm, 7 1/2" | EV33275-19 |
| EV33274-22 | 22 cm, 8 3/4" | EV33275-22 |



**BÖHLER**

- |                      |
|----------------------|
| EV33280-15           |
| EV33281-15 15 cm, 6" |



**COTTLE-KAZANJIAN**

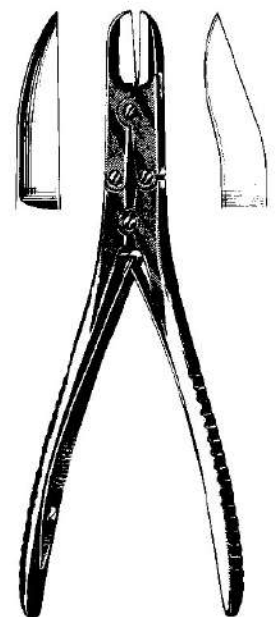
- |                             |
|-----------------------------|
| EV33282-19 19 cm,<br>7 1/2" |
|-----------------------------|



**MC INDOE**  
 EV33283-17  
 17 cm, 6 3/4"



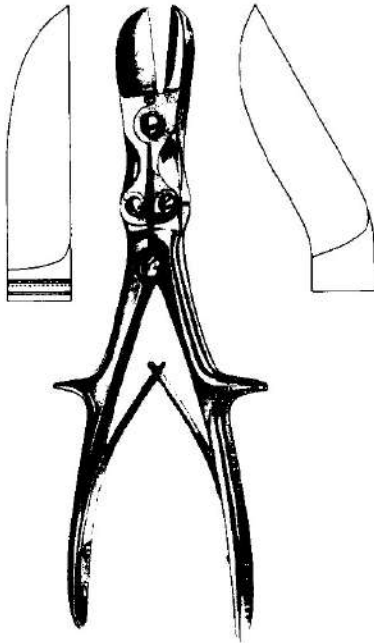
**STAMM**  
 EV33284-15  
 15 cm, 6"



**RUSKIN-LISTON**

- |                      |
|----------------------|
| EV33286-18           |
| EV33289-18 18 cm, 7" |

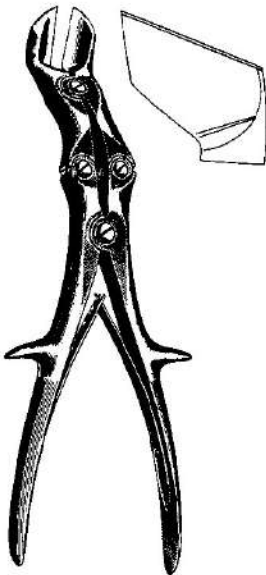
Knochensplitterzangen  
 Bone Cutting Forceps  
 Pinzas cortantes para huesos  
 Cesioie per ossa



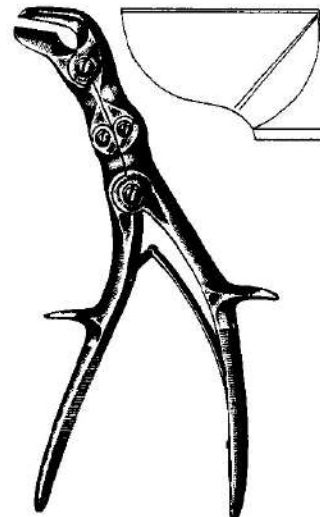
— STILLE-LISTON —  
 EV33290-23 23 cm, 9" EV33291-23  
 EV33290-27 27 cm, 10 1/2" EV33291-27



STILLE-LISTON  
 EV33292-26  
 26 cm, 10 1/4"

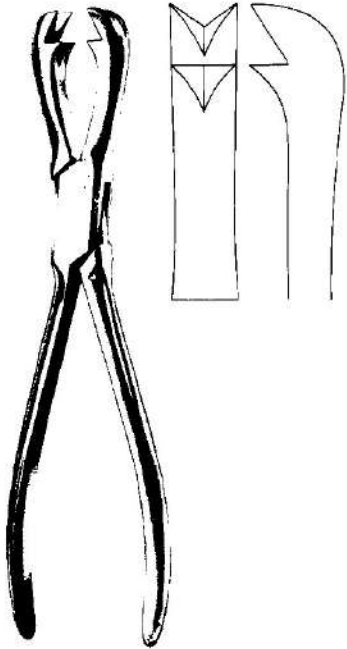


STILLE-HORSLEY  
 EV33293-27 27  
 cm, 10 1/2"

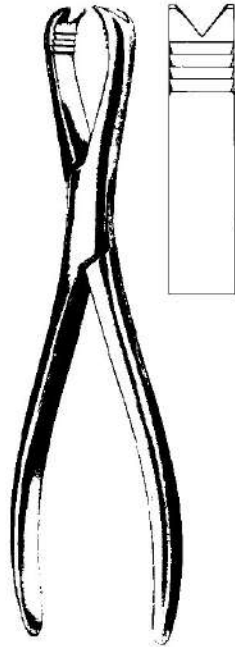


SEMB  
 EV33295-24  
 24 cm, 9 1/2"

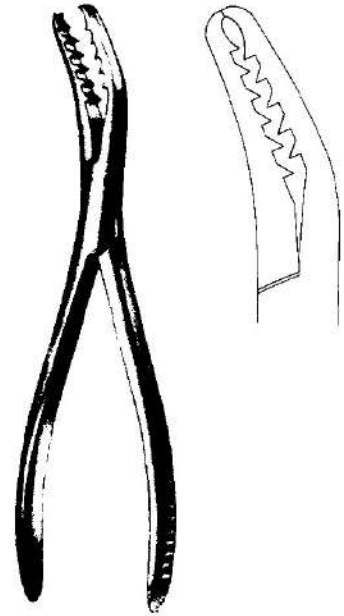
Knochenhaltezangen  
 Bone Holding Forceps  
 Pinzas para huesos  
 Tenaglie per ossa



FERGUSSON  
 EV33360-21  
 21 cm, 8 1/4"



LANGENBECK  
 EV33362-21  
 21 cm, 8 1/4"



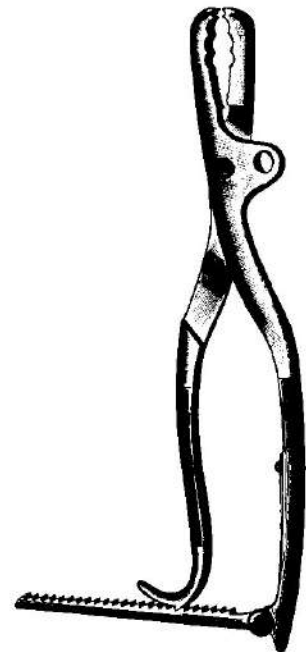
SEMB  
 EV33365-19  
 19 cm, 7 1/2"



SEMB  
 EV33366-19  
 20 cm, 8"



FARABEUF  
 EV33366-23 23 cm, 9"  
 EV33366-26 26 cm, 10 1/4"

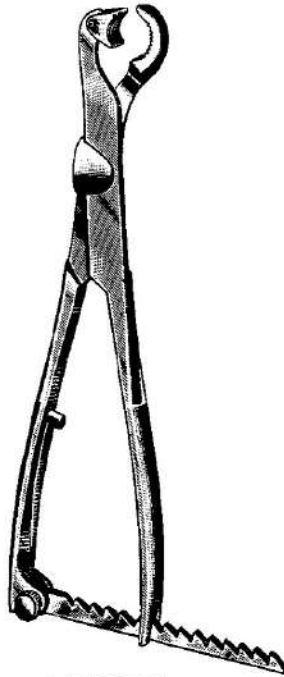


FARABEUF-LAMBOTTE  
 EV33368-26 26 cm,  
 10 1/4"

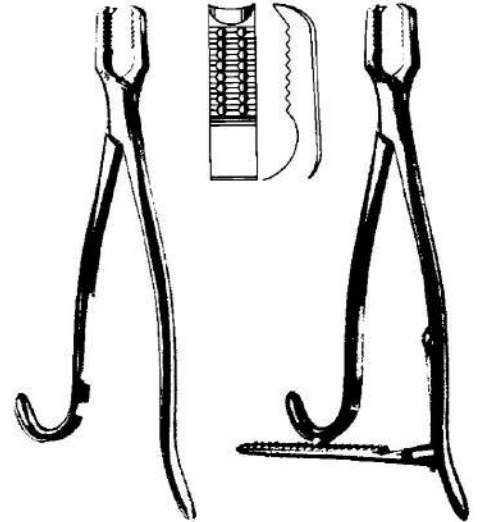




LAMBOTTE  
EV33370-22 22 cm, 8 3/4"  
EV33370-27 27 cm, 10 1/2"  
EV33370-30 30 cm, 11 3/4"



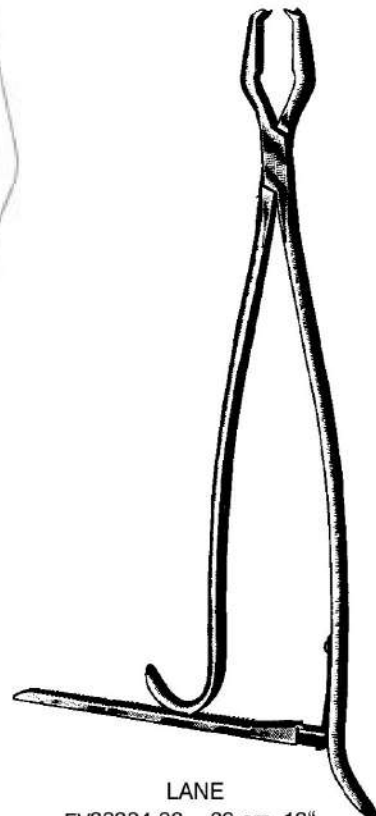
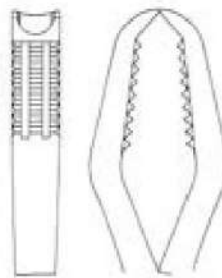
LAMBOTTE  
EV33372-22 22 cm, 8 3/4"  
EV33372-26 26 cm, 10 1/4"  
EV33372-33 33 cm, 13"



KERN  
EV33378-15 15 cm, 6" EV33380-15  
EV33378-17 17 cm, 6 3/4" EV33380-17  
EV33378-21 21 cm, 8 1/4" EV33380-21



LANE  
EV33382-33 33 cm, 13"  
EV33382-45 45 cm, 17 3/4"



LANE  
EV33384-33 33 cm, 13"  
EV33384-45 45 cm, 17 3/4"

Knochenhaltezangen  
Bone Holding Forceps  
Pinzas para huesos  
Tenaglie per ossa

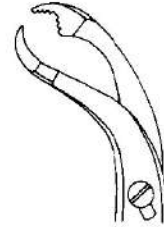
selbstzentrierend  
self-centering  
autocentrantes  
autocentranti

2,5 mm



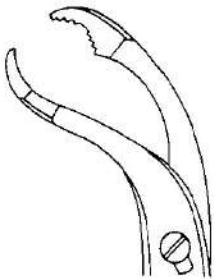
EV33391-15  
15 cm, 6"

6,5 mm



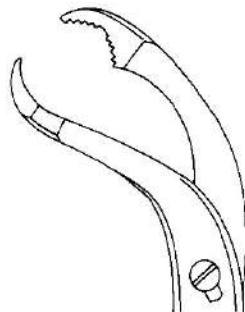
EV33391-19  
19 cm, 7 1/2"

9,5 mm



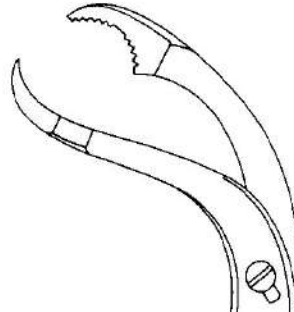
EV33391-24  
24 cm, 9 1/2"

10 mm

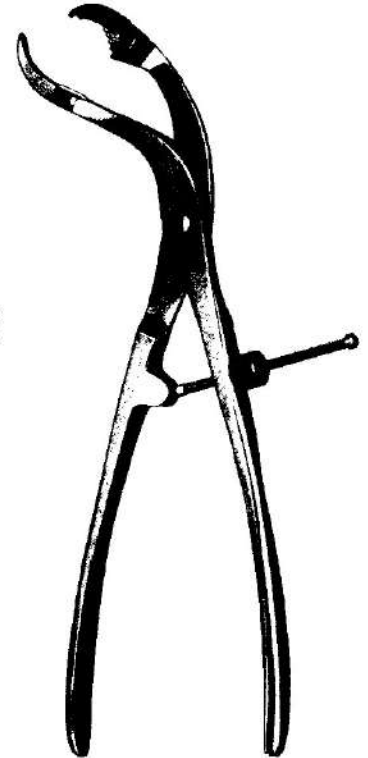


EV33391-26  
26 cm, 10 1/4"

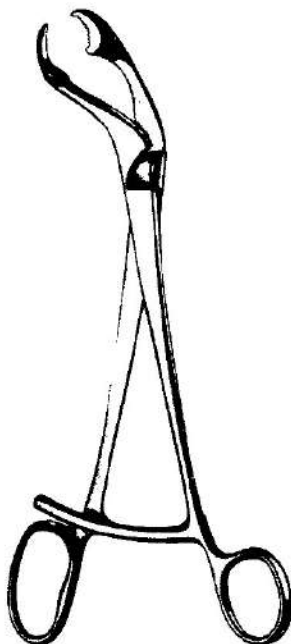
11 mm



EV33391-28  
28 cm, 11"



EV33391-15 - EV33391-28



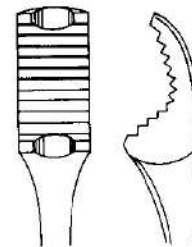
VERBRUGGE  
EV33395-17 - EV33395-27

5 mm



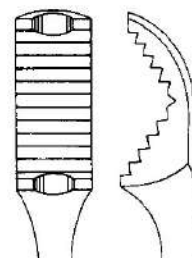
EV33395-17  
17,5 cm, 7"

9,5 mm



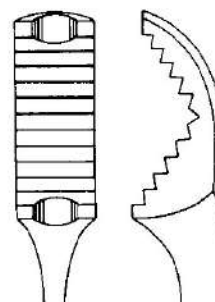
EV33395-25  
25 cm, 10"

10,5 mm

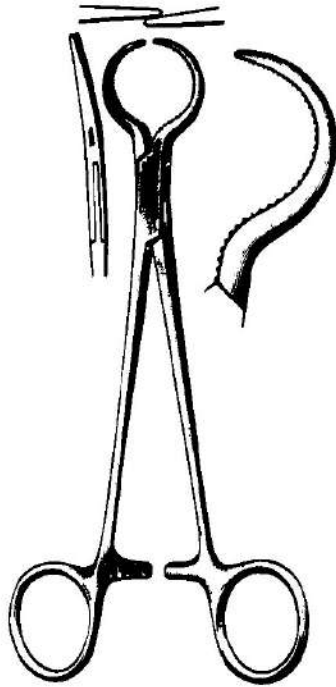


EV33395-26  
26 cm, 10 1/4"

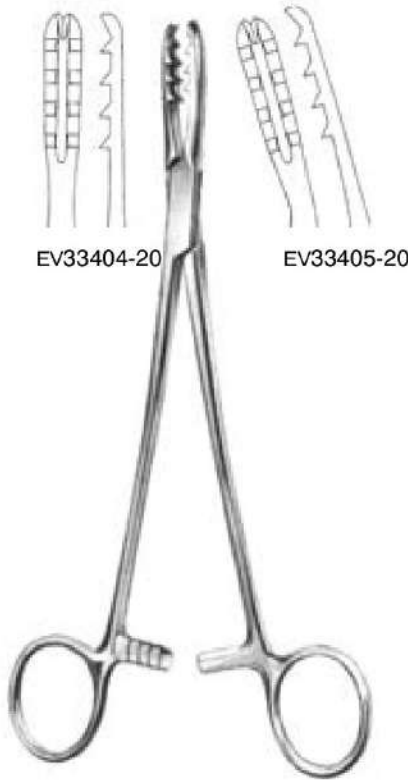
12 mm



EV33395-27  
27 cm, 10 1/2"



LEWIN  
 EV33402-17  
 17,5 cm, 7"



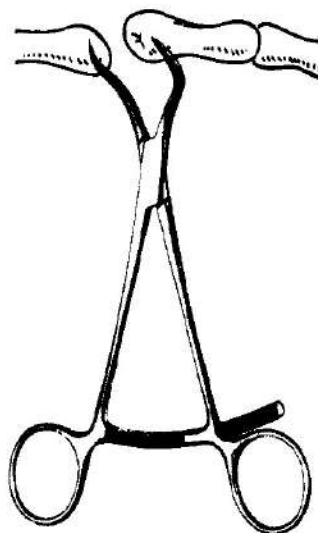
BIRCHER-GANSKE  
 20 cm, 8"



EV33406-20  
 20 cm, 8"



DINGMANN  
 EV33407-19  
 19 cm, 7 1/2"

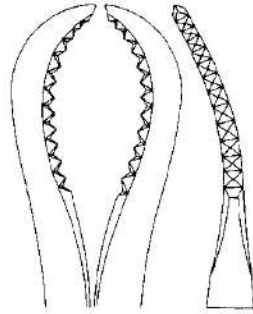


ELGEN  
 EV33409-13  
 13,5 cm, 5 1/4"

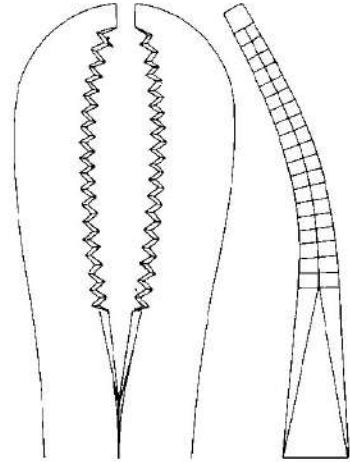


MARTIN  
 EV33410-19  
 19 cm, 7 1/2"

Knochenhaltezangen  
Bone Holding Forceps  
Pinzas para huesos  
Tenaglie per ossa

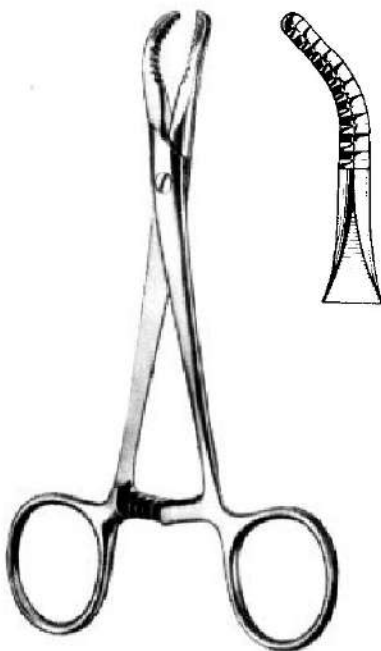


EV33412-16  
16 cm, 6 1/4"



EV33412-24  
24 cm, 9 1/2"

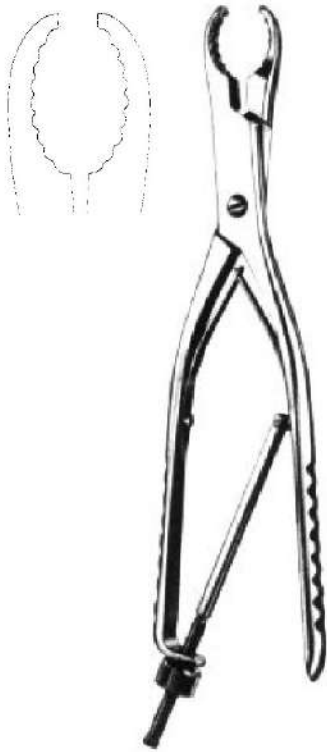
ELGEN  
EV33412-16 - EV33412-24



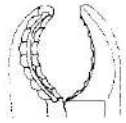
ELGEN  
EV33413-14  
13,5 cm, 5 1/4"



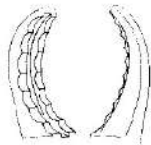
EV33414-21  
21 cm, 8 1/4"



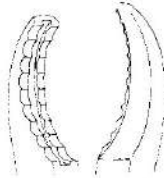
ULRICH  
 EV33415-23 - EV33415-28



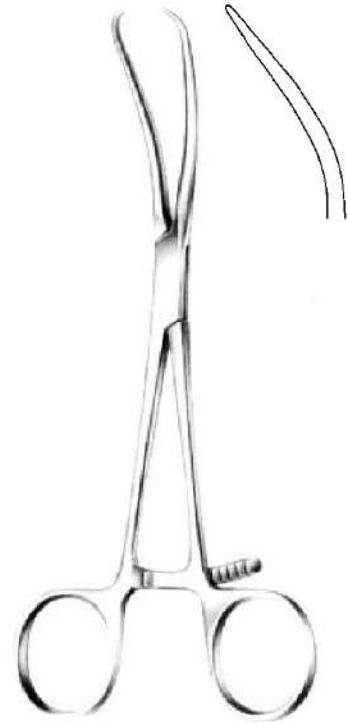
EV33415-23  
 23 cm, 9"



EV33415-25  
 25 cm, 10"



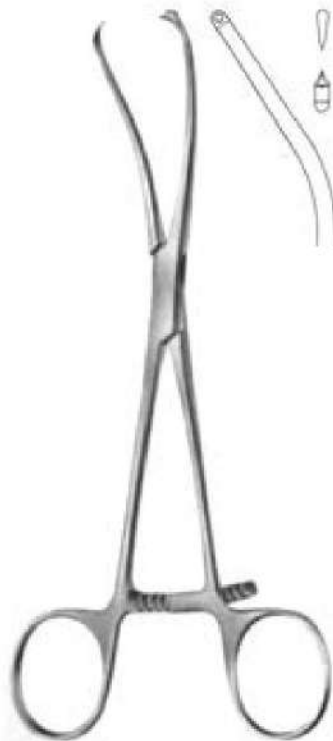
EV33415-28  
 28 cm, 11"



REILL  
 EV33416-17 17 cm, 6 3/4"



PATELLA  
 EV33417-18 18,5 cm, 7 1/4"

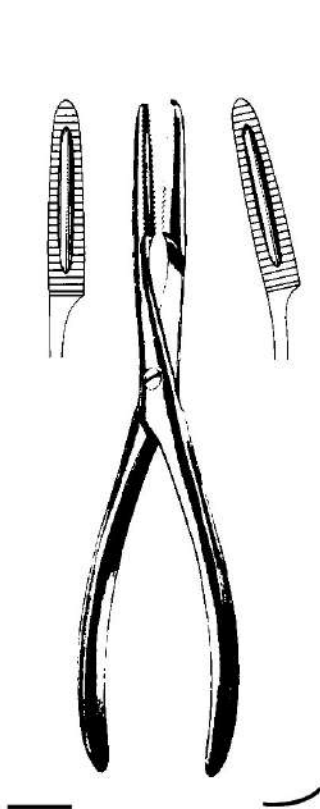


MEYER  
 EV33418-17 17 cm, 6 3/4"

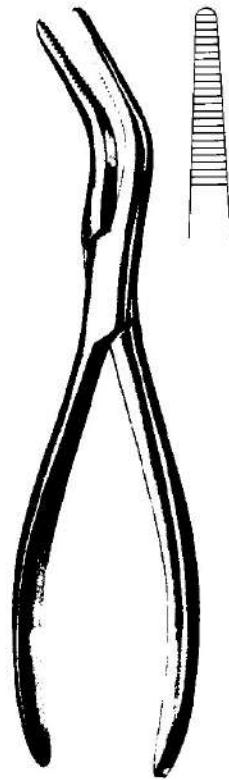


MEYER  
 EV33419-20 20,5 cm, 8"

Knochenhaltezangen, -Klammern  
 Bone holding forceps, -Clamps  
 Pinzas para huesos, Clamps porta-huesos  
 Tenaglie per ossa, Pinze per ossa



EV33420-20 EV33421-20  
 20 cm, 8"



VAN BUREN  
 EV33423-23  
 23 cm, 9"



FELDHEIM  
 EV33424-10  
 10 cm, 4"



LOWMAN  
 EV33441-13 13 cm, 5 1/8"  
 EV33441-18 18 cm, 7"  
 EV33441-20 20 cm, 8"

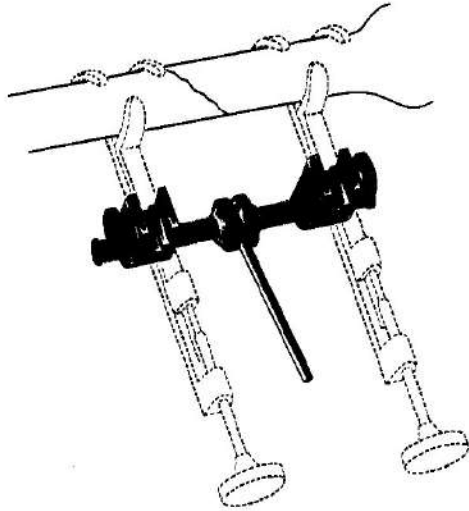


LOWMAN-HOGLUND  
 EV33442-19  
 19 cm, 7 1/2"



LAMBERT-LOWMAN  
 EV33443-18  
 18 cm, 7"

Knochenhalte­zangen, Bleihand  
Bone holding forceps, Lead Hands  
Pinzas para huesos, Manoplas de plomo  
Tenaglie per ossa, Mani di piombo



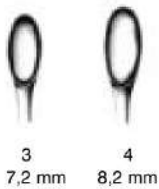
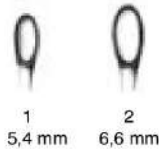
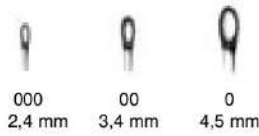
GERSTER  
EV33444-15



EV33450-01  
32 cm, 12 <sup>3</sup>/<sub>4</sub>"  
Erwachsen  
adult size  
p. adultos  
p. adulti

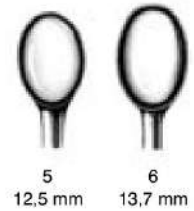
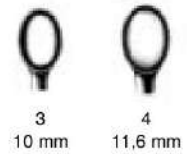
EV33450-02  
24 cm, 9 <sup>1</sup>/<sub>2</sub>"  
Kind  
child size  
p. niños  
p. bambini

Scharfe Löffel  
Bone Curettes  
Cucharillas cortantes  
Curette taglianti

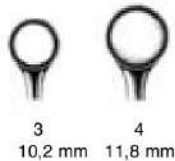
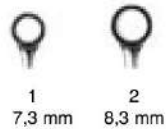
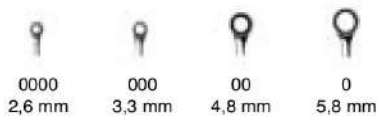


| SCHEDE     | Fig. | VOLKMANN   |
|------------|------|------------|
|            | 0000 | EV33469-96 |
| EV33467-97 | 000  | EV33469-97 |
| EV33467-98 | 00   | EV33469-98 |
| EV33468-00 | 0    | EV33470-00 |
| EV33468-01 | 1    | EV33470-01 |
| EV33468-02 | 2    | EV33470-02 |
| EV33468-03 | 3    | EV33470-03 |
| EV33468-04 | 4    | EV33470-04 |
|            | 5    | EV33470-05 |
|            | 6    | EV33470-06 |

SCHEDE  
17 cm, 6 3/4"  
EV33467-97 - EV33468-04

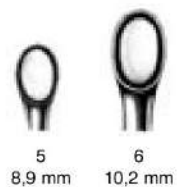
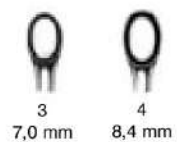
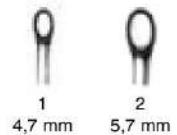
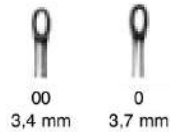
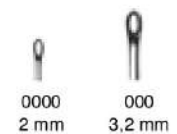


VOLKMANN  
17 cm, 6 3/4"  
EV33469-96 - EV33470-06



| BRUNS      | Fig. | SPRATT     |
|------------|------|------------|
| EV33471-96 | 0000 | EV33474-96 |
| EV33471-97 | 000  | EV33474-97 |
| EV33471-98 | 00   | EV33474-98 |
| EV33472-00 | 0    | EV33475-00 |
| EV33472-01 | 1    | EV33475-01 |
| EV33472-02 | 2    | EV33475-02 |
| EV33472-03 | 3    | EV33475-03 |
| EV33472-04 | 4    | EV33475-04 |
| EV33472-05 | 5    | EV33475-05 |
| EV33472-06 | 6    | EV33475-06 |

BRUNS  
17 cm, 6 3/4"  
EV33471-96 - EV33472-06



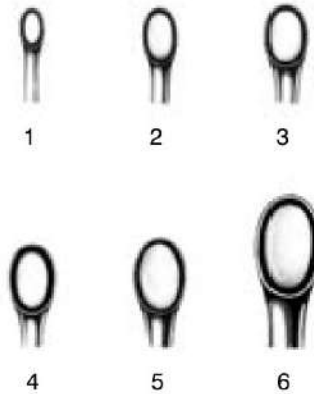
SPRATT  
17 cm, 6 3/4"  
EV33474-97 - EV33475-06



Scharfe Löffel  
 Bone Currettes  
 Cucharillas cortantes  
 Curette taglienti

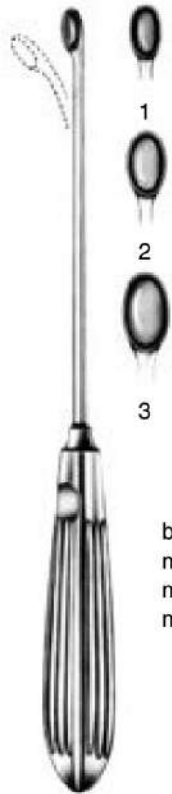


COBB  
 27,9 cm 11"



|      |            |         |
|------|------------|---------|
| Fig. |            |         |
| 1    | EV33473-01 | 3,5 mm  |
| 2    | EV33473-02 | 4,5 mm  |
| 3    | EV33473-03 | 5,5 mm  |
| 4    | EV33473-04 | 7,5 mm  |
| 5    | EV33473-05 | 8,5 mm  |
| 6    | EV33473-06 | 10,0 mm |

Scharfe Löffel  
Bone Curettes  
Cucharillas cortantes  
Curette taglienti



- Fig.  
1 EV33476-01 4,8 mm  
2 EV33476-02 5,8 mm  
3 EV33476-03 6,8 mm

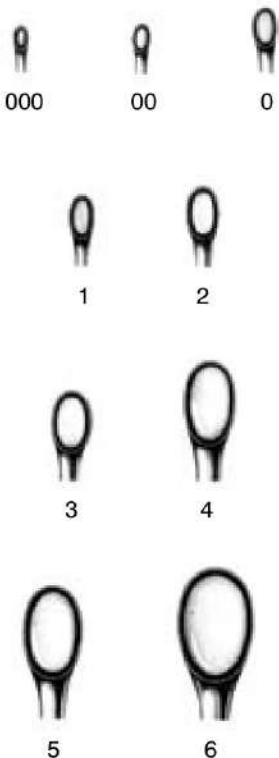
biegsam  
malleable  
maleable  
malleabile

HALLE  
21 cm, 8 1/4"  
EV33476-01 - EV33476-02



- Fig.  
000 EV33476-98 2,8 mm  
00 EV33476-99 3,3 mm  
0 EV33477-00 3,7 mm  
1 EV33477-01 4,3 mm  
2 EV33477-02 4,8 mm  
3 EV33477-03 5,6 mm  
4 EV33477-04 6,1 mm  
5 EV33477-05 6,7 mm  
6 EV33477-06 8,8 mm

SPINAL  
20 cm, 8"  
EV33476-98 - EV33477-06





- Fig.  
000 EV33478-98 2,8 mm  
00 EV33478-99 3,3 mm  
0 EV33479-00 3,7 mm  
1 EV33479-01 4,3 mm  
2 EV33479-02 4,8 mm  
3 EV33479-03 5,6 mm  
4 EV33479-04 6,1 mm  
5 EV33479-05 6,7 mm  
6 EV33479-06 8,8 mm

SPINAL  
20 cm, 8"  
EV33478-98 - EV33479-06



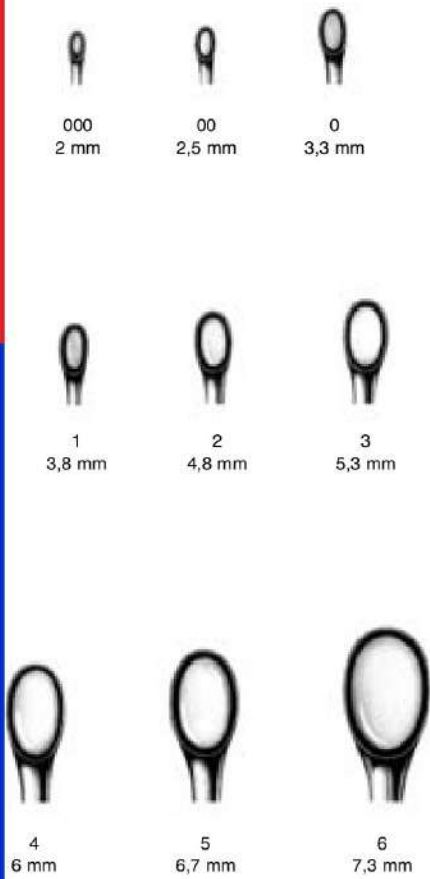
- 
- EV33482-01 4,7 mm

- 
- EV33482-02 4,7 mm

- 
- EV33482-03 4,7 mm

SCOVILLE  
25 cm, 10"  
EV33482-01 - EV33482-03

Scharfe Löffel  
 Bone Curettes  
 Cucharillas cortantes  
 Curette taglienti



BRUNS 23  
 cm, 9"



BRUNS  
 23 cm, 9"

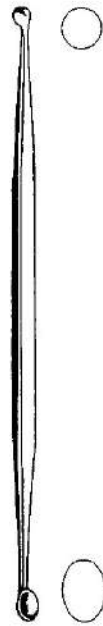


BRUNS  
 23 cm, 9"

Fig.

|     |            |            |        |            |        |
|-----|------------|------------|--------|------------|--------|
| 000 | EV33480-97 | EV33482-97 | 2,8 mm | EV33484-97 | 2,8 mm |
| 00  | EV33480-98 | EV33482-98 | 3,3 mm | EV33484-98 | 3,3 mm |
| 0   | EV33481-00 | EV33483-00 | 3,7 mm | EV33485-00 | 3,7 mm |
| 1   | EV33481-01 | EV33483-01 | 4,3 mm | EV33485-01 | 4,3 mm |
| 2   | EV33481-02 | EV33483-02 | 4,8 mm | EV33485-02 | 4,8 mm |
| 3   | EV33481-03 | EV33483-03 | 5,6 mm | EV33485-03 | 5,6 mm |
| 4   | EV33481-04 | EV33483-04 | 6,1 mm | EV33485-04 | 6,1 mm |
| 5   | EV33481-05 | EV33483-05 | 6,7 mm | EV33485-05 | 6,7 mm |
| 6   | EV33481-06 | EV33483-06 | 8,8 mm | EV33485-06 | 8,8 mm |

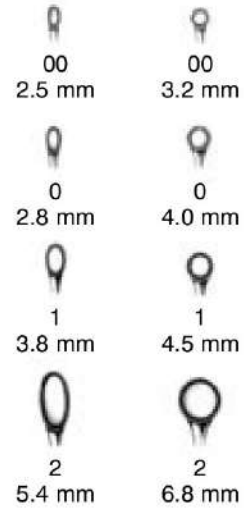
Scharfe Löffel  
Bone Curettes  
Cucharillas cortantes  
Curette taglienti



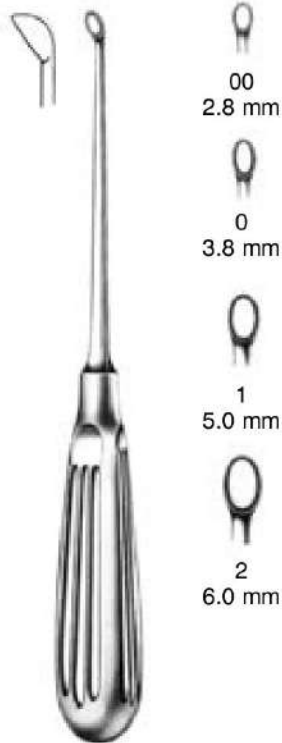
EV33485-21 21 cm, 8  
1/4" oval/rund ovale/  
ronde ovalado/redondo  
ovale/rotonda



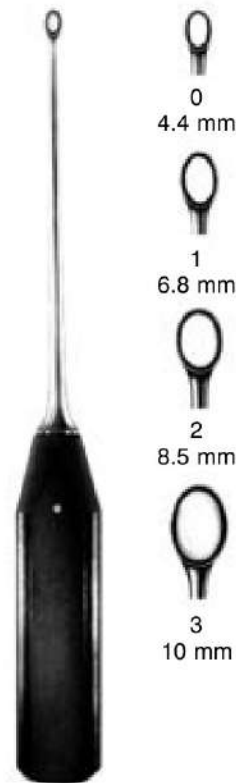
WILLIGER  
17,5 cm  
7"



|         |            |            |
|---------|------------|------------|
| Fig. 00 | EV33485-99 | EV33486-99 |
| 0       | EV33486-00 | EV33487-00 |
| 1       | EV33486-01 | EV33487-01 |
| 2       | EV33486-02 | EV33487-02 |



DAUBENSPECK Fig. 00 EV334EV87-99  
20 cm, 8" 0 EV33488-00 1  
EV33488-01 2  
EV33488-02



27 cm Fig. 0 EV33489-00  
10 1/2" 1 EV33489-01  
2 EV33489-02  
3 EV33489-03

Scharfe Löffel  
Bone Curettes  
Cucharillas cortantes  
Curette taglianti



LEMPERT  
17,5 cm, 7"



0



00



000



0000

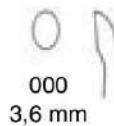


00000

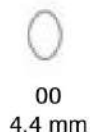
|        |            |        |
|--------|------------|--------|
| Fig. 0 | EV33490-10 | 3,3    |
| mm 00  | EV33490-20 | 3,0 mm |
| 000    | EV33490-30 | 2,7 mm |
| 0000   | EV33490-40 | 2,4 mm |
| 00000  | EV33490-50 | 2,0 mm |



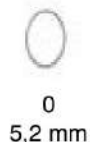
ELGEN  
25 cm, 10"



000  
3,6 mm



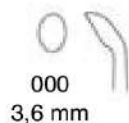
00  
4,4 mm



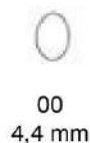
0  
5,2 mm



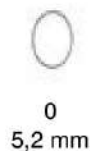
1  
6,8 mm



000  
3,6 mm



00  
4,4 mm



0  
5,2 mm



1  
6,8 mm

|          |            |
|----------|------------|
| Fig. 000 | EV33491-05 |
| 00       | EV33491-06 |
| 0        | EV33491-07 |
| 1        | EV33491-08 |



ELGEN  
25 cm, 10"

|          |            |
|----------|------------|
| Fig. 000 | EV33500-01 |
| 00       | EV33500-02 |
| 0        | EV33500-03 |



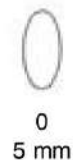
BUSHE  
25 cm, 10"



000  
3 mm

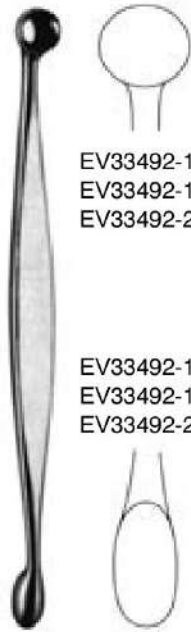


00  
4 mm



0  
5 mm

Scharfe Löffel  
Bone Curettes  
Cucharillas cortantes  
Curette taglienti



EV33492-13 6.8 mm  
EV33492-16 9.0 mm  
EV33492-20 11.1 mm

EV33492-13 6.3 mm  
EV33492-16 7.0 mm  
EV33492-20 9.1 mm

**VOLKMANN**

EV33492-13 13 cm, 5 1/8"  
EV33492-16 16 cm, 6 1/4"  
EV33492-20 20 cm, 8"



EV33494-13 7.5 mm  
EV33494-14 6.8 mm  
EV33494-17 6.8 mm  
EV33494-13 6.3 mm  
EV33494-14 6.2 mm  
EV33494-17 7.3 mm

**VOLKMANN**

EV33494-13 13 cm, 5 1/8"  
EV33494-14 14 cm, 5 1/2"  
EV33494-17 17 cm, 6 3/4"

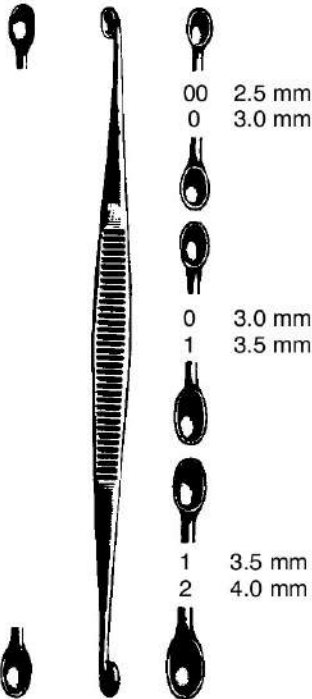


5.2 mm

3.5 mm

**JANSEN**

EV33495-16  
16 cm, 6 1/4"



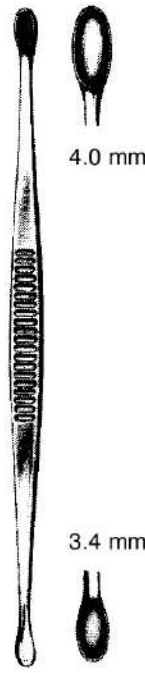
00 2.5 mm  
0 3.0 mm

0 3.0 mm  
1 3.5 mm

1 3.5 mm  
2 4.0 mm

**WILLIGER 13,5**

cm, 5 1/4" Fig.  
EV33496-00 00/0  
EV33496-01 0/1  
EV33496-12 1/2

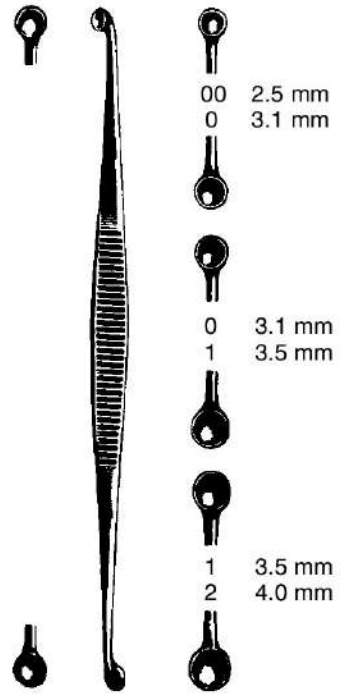


4.0 mm

3.4 mm

**JACOBSON**

13 cm, 5 1/8"  
EV33497-00



00 2.5 mm  
0 3.1 mm

0 3.1 mm  
1 3.5 mm

1 3.5 mm  
2 4.0 mm

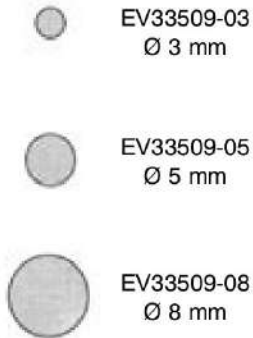
**MARTINI**

13,5 cm, 5 1/4"  
EV33498-00  
EV33498-01  
EV33498-12

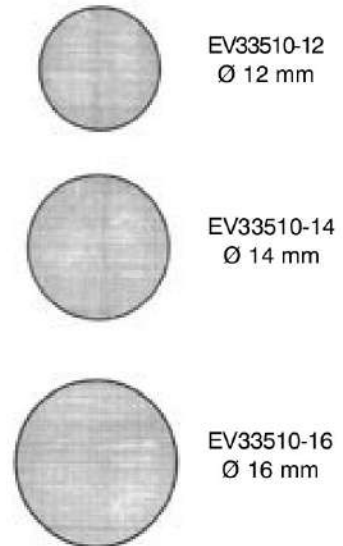
Stößel  
Hemostats  
Hemostáticos  
Pistoni



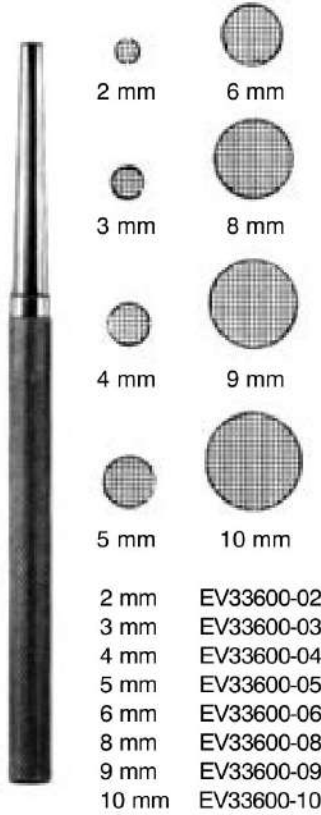
CASPAR  
200 mm, 8"



200 mm, 8"



Stößel, Flachmeißel, Hohlmeißel, Osteotome  
 Hemostats, Chisels, Gouges, Osteotome  
 Hemostáticos, Cinceles, Gubias, Osteótomo  
 Pistoni, scalpelli, sgorbie, Osteotomia



16 cm, 6 1/4"

|       |            |
|-------|------------|
| 2 mm  | EV33600-02 |
| 3 mm  | EV33600-03 |
| 4 mm  | EV33600-04 |
| 5 mm  | EV33600-05 |
| 6 mm  | EV33600-06 |
| 8 mm  | EV33600-08 |
| 9 mm  | EV33600-09 |
| 10 mm | EV33600-10 |



13,5 cm, 5 1/4" 4 mm

|                  |
|------------------|
| EV33602-04       |
| 6 mm EV33602-06  |
| 8 mm EV33602-08  |
| 10 mm EV33602-10 |
| 12 mm EV33602-12 |
| 14 mm EV33602-14 |
| 16 mm EV33602-16 |



13,5 cm, 5 1/4"

|            |
|------------|
| EV33604-04 |
| EV33604-06 |
| EV33604-08 |
| EV33604-10 |
| EV33604-12 |
| EV33604-14 |
| EV33604-16 |



13,5 cm, 5 1/4"

|            |
|------------|
| EV33605-04 |
| EV33605-06 |
| EV33605-08 |
| EV33605-10 |
| EV33605-12 |
| EV33605-14 |
| EV33605-16 |



ALEXANDER  
17 cm, 6 3/4"

|            |       |
|------------|-------|
| EV33610-04 | 4 mm  |
| EV33610-06 | 6 mm  |
| EV33610-08 | 8 mm  |
| EV33610-10 | 10 mm |
| EV33610-12 | 12 mm |
| EV33610-14 | 14 mm |



ALEXANDER  
17 cm, 6 3/4"

|            |       |
|------------|-------|
| EV33611-04 | 4 mm  |
| EV33611-06 | 6 mm  |
| EV33611-08 | 8 mm  |
| EV33611-10 | 10 mm |
| EV33611-12 | 12 mm |
| EV33611-14 | 14 mm |



PARTSCH  
13,5 cm, 5 1/4" mm 17 cm, 6 3/4"

|            |   |            |
|------------|---|------------|
| EV33620-02 | 2 | EV33622-02 |
| EV33620-03 | 3 | EV33622-03 |
| EV33620-04 | 4 | EV33622-04 |
| EV33620-05 | 5 | EV33622-05 |
| EV33620-06 | 6 | EV33622-06 |
| EV33620-07 | 7 | EV33622-07 |
| EV33620-08 | 8 | EV33622-08 |

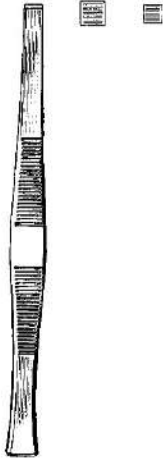


PARTSCH  
13,5 cm, 5 1/4" mm 17 cm, 6 3/4"

|            |   |            |
|------------|---|------------|
| EV33623-02 | 2 | EV33625-02 |
| EV33623-03 | 3 | EV33625-03 |
| EV33623-04 | 4 | EV33625-04 |
| EV33623-05 | 5 | EV33625-05 |
| EV33623-06 | 6 | EV33625-06 |
| EV33623-07 | 7 | EV33625-07 |
| EV33623-08 | 8 | EV33625-08 |



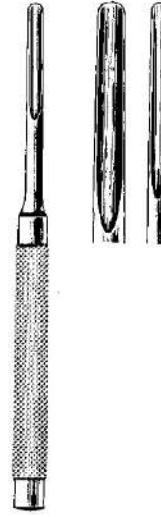
Flachmeißel, Hohlmeißel, Osteotome  
 Chisels, Gouges, Osteotome  
 Cinceles, Gubias, Osteótomo  
 Scalpelli, sgorbie, Osteotomia



**PASSOW**  
 12 cm, 4 3/4"  
 EV33626-35 3,5 mm  
 EV33626-25 2,5 mm



**BRÜNINGS-LUCAS**  
 16 cm, 6 1/4"  
 EV33627-04 4 mm  
 EV33627-06 6 mm



**BRÜNINGS-LUCAS**  
 16 cm, 6 1/4"  
 EV33628-03 3 mm  
 EV33628-05 5 mm



**STILLE**  
 20 cm, 8"  
 EV33630-06 6 mm  
 EV33630-08 8 mm  
 EV33630-10 10 mm  
 EV33630-12 12 mm  
 EV33630-15 15 mm  
 EV33630-20 20 mm  
 EV33630-25 25 mm  
 EV33630-30 30 mm



**STILLE**  
 20 cm, 8"

EV33631-10 6 mm  
 EV33631-12 8 mm  
 EV33631-15 10 mm  
 EV33631-20 12 mm  
 EV33631-25 15 mm  
 EV33631-30 20 mm



**STILLE**  
 20 cm, 8"

EV33632-06 25 mm  
 EV33632-08 30 mm  
 EV33632-10 35 mm  
 EV33632-12 40 mm  
 EV33632-15 45 mm  
 EV33632-20 50 mm  
 EV33632-25 55 mm  
 EV33632-30 60 mm



**STILLE**  
 20 cm, 8"

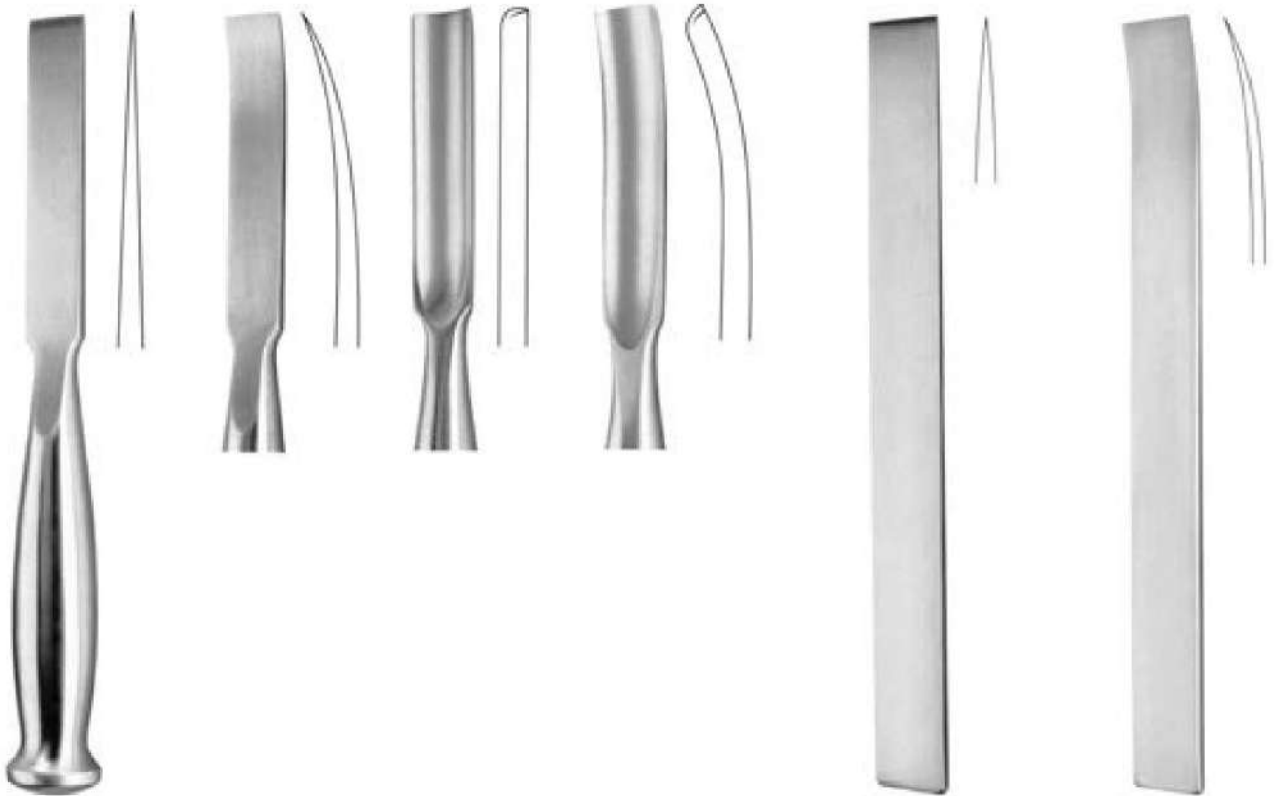
EV33633-06 25 mm  
 EV33633-08 30 mm  
 EV33633-10 35 mm  
 EV33633-12 40 mm  
 EV33633-15 45 mm  
 EV33633-20 50 mm  
 EV33633-25 55 mm  
 EV33633-30 60 mm



**STILLE**  
 20 cm, 8"

EV33634-06 25 mm  
 EV33634-08 30 mm  
 EV33634-10 35 mm  
 EV33634-12 40 mm  
 EV33634-15 45 mm  
 EV33634-20 50 mm  
 EV33634-25 55 mm  
 EV33634-30 60 mm

Osteotome, Hohlmeißel  
 Osteotome, Gouges  
 Osteótomo, Gubias  
 Osteotomia, sgorbie



SMITH-PETERSEN  
 20 cm, 8"

|       |            |            |            |            |
|-------|------------|------------|------------|------------|
| 6 mm  | EV33644-06 | EV33645-06 | EV33647-06 |            |
| 9 mm  | EV33644-09 | EV33645-09 | EV33647-09 | EV33649-09 |
| 13 mm | EV33644-13 | EV33645-13 |            |            |
| 14 mm |            |            | EV33647-14 | EV33649-14 |
| 16 mm | EV33644-16 | EV33645-16 | EV33647-16 | EV33649-16 |
| 19 mm | EV33644-19 | EV33645-19 | EV33647-19 | EV33649-19 |
| 25 mm | EV33644-25 | EV33645-25 | EV33647-25 | EV33649-25 |
| 32 mm | EV33644-32 | EV33645-32 | EV33647-32 | EV33649-32 |

LAMBOTTE

24 cm, 9 1/2"

23 cm, 9"

|            |       |            |
|------------|-------|------------|
| EV33650-04 | 4 mm  | EV33651-04 |
| EV33650-06 | 6 mm  | EV33651-06 |
| EV33650-08 | 8 mm  | EV33651-08 |
| EV33650-10 | 10 mm | EV33651-10 |
| EV33650-13 | 13 mm | EV33651-13 |
| EV33650-16 | 16 mm | EV33651-16 |
| EV33650-18 | 18 mm | EV33651-18 |
| EV33650-20 | 20 mm | EV33651-20 |
| EV33650-25 | 25 mm | EV33651-25 |
| EV33650-30 | 30 mm | EV33651-30 |
| EV33650-38 | 38 mm | EV33651-38 |
| EV33650-44 | 44 mm | EV33651-44 |
| EV33650-50 | 50 mm | EV33651-50 |

Osteotome, Hohlmeißel  
 Osteotome, Chisels, Gouges  
 Osteótomo, Cinceles, Gubias  
 Osteotomia, Scalpelli, sgorbie



MINI-LAMBOTTE



2 mm



3 mm



4 mm



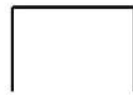
6 mm



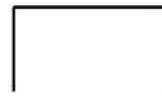
8 mm



10 mm



12 mm



15 mm

|             |    |               |
|-------------|----|---------------|
| 12,5 cm, 5" | mm | 17 cm, 6 3/4" |
| EV33654-02  | 2  | EV33652-02    |
| EV33654-03  | 3  | EV33652-03    |
| EV33654-04  | 4  | EV33652-04    |
| EV33654-06  | 6  | EV33652-06    |
| EV33654-08  | 8  | EV33652-08    |
| EV33654-10  | 10 | EV33652-10    |
| EV33654-12  | 12 | EV33652-12    |
| EV33654-15  | 15 | EV33652-15    |

8 mm



COBB  
 28 cm, 11"  
 EV33656-28

8 mm



COBB  
 28 cm, 11"  
 EV33657-28

8 mm



COBB  
 28 cm, 11"  
 EV33658-28

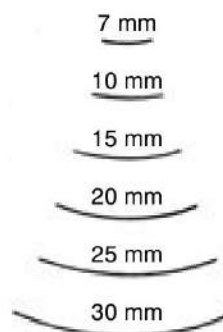
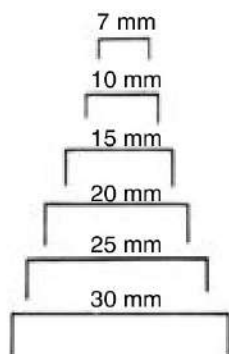
8 mm



COBB  
 28 cm, 11"  
 EV33659-28

mit Ferrozellgriff  
 with Ferrozell-Handle  
 con mango de Ferrozell  
 con manico di Ferrozell

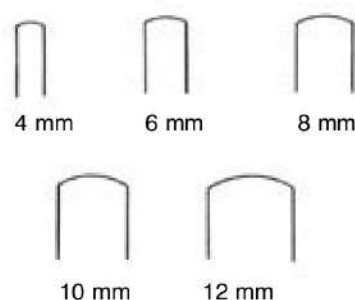
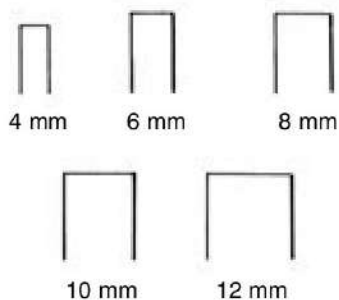
Osteotome und Hohlmeißel mit Ferrozell-Griff  
 Osteotome and Gouges with Ferrozell-Handle  
 Osteótomo, Gubias con mango de Ferrozell  
 Osteotomo, con manico di Ferrozell



- |            |       |            |
|------------|-------|------------|
| EV33660-07 | 7 mm  | EV33661-07 |
| EV33660-10 | 10 mm | EV33661-10 |
| EV33660-15 | 15 mm | EV33661-15 |
| EV33660-20 | 20 mm | EV33661-20 |
| EV33660-25 | 25 mm | EV33661-25 |
| EV33660-30 | 30 mm | EV33661-30 |

LEXER  
22 cm, 8 3/4"

LEXER  
22 cm, 8 3/4"



- |            |       |            |
|------------|-------|------------|
| EV33664-04 | 4 mm  | EV33665-04 |
| EV33664-06 | 6 mm  | EV33665-06 |
| EV33664-08 | 8 mm  | EV33665-08 |
| EV33664-10 | 10 mm | EV33665-10 |
| EV33664-12 | 12 mm | EV33665-12 |

LEXER MINI  
18 cm, 7"

LEXER MINI  
18 cm, 7"

Flachmeißel, Hohlmeißel  
Chisels, Gouges  
Cinceles, Gubias  
Scalpelli, sgorbie



20 mm



16 mm

mit Ferrozellgriff  
with Ferrozell-Handle  
con mango de Ferrozell  
con manico di Ferrozell

EV33665-24  
24,5 cm, 9 3/4"

EV33665-26  
26,5 cm, 10 1/2"



ZIELKE 23 cm, 9"  
EV33665-55 5,5 mm  
EV33665-90 9,0 mm



22 cm, 8 3/4"  
EV33666-22

9 mm



|            |            |            |
|------------|------------|------------|
| —          | 25 cm, 10" | ⌒          |
| EV33669-05 | 5 mm       | EV33670-05 |
| EV33669-10 | 10 mm      | EV33670-10 |
| EV33669-15 | 15 mm      | EV33670-15 |

mit NOVOTEX-Griff  
with Novotex-Handle  
con mango de Novotex  
con manico di Novotex

Osteotome, Flachmeißel, Hohlmeißel  
 Osteotome, Chisels, Gouges  
 Osteótomo, Cinceles, Gubias  
 Osteotomia, Scalpelli, Sgorbie



HOKE  
 14 cm, 5 1/2"

|            |       |
|------------|-------|
| EV33668-03 | 3 mm  |
| EV33668-05 | 5 mm  |
| EV33668-06 | 6 mm  |
| EV33668-08 | 8 mm  |
| EV33668-09 | 9 mm  |
| EV33668-13 | 13 mm |
| EV33668-16 | 16 mm |
| EV33668-19 | 19 mm |



HIBBS  
 24 cm, 9 1/2"

|            |       |
|------------|-------|
| EV33670-06 | 6 mm  |
| EV33670-09 | 9 mm  |
| EV33670-13 | 13 mm |
| EV33670-16 | 16 mm |
| EV33670-19 | 19 mm |
| EV33670-25 | 25 mm |
| EV33670-32 | 32 mm |



HIBBS  
 24 cm, 9 1/2"

|            |       |
|------------|-------|
| EV33671-06 | 6 mm  |
| EV33671-09 | 9 mm  |
| EV33671-13 | 13 mm |
| EV33671-16 | 16 mm |
| EV33671-19 | 19 mm |
| EV33671-25 | 25 mm |
| EV33671-32 | 32 mm |



HIBBS  
 24 cm, 9 1/2"

|            |       |
|------------|-------|
| EV33672-06 | 6 mm  |
| EV33672-09 | 9 mm  |
| EV33672-13 | 13 mm |
| EV33672-16 | 16 mm |
| EV33672-19 | 19 mm |
| EV33672-25 | 25 mm |
| EV33672-32 | 32 mm |



HIBBS  
 24 cm, 9 1/2"

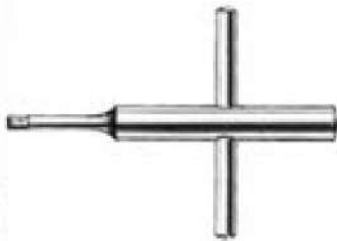
|            |       |
|------------|-------|
| EV33673-06 | 6 mm  |
| EV33673-09 | 9 mm  |
| EV33673-13 | 13 mm |
| EV33673-16 | 16 mm |
| EV33673-19 | 19 mm |
| EV33673-25 | 25 mm |
| EV33673-32 | 32 mm |



HIBBS  
 24 cm, 9 1/2"

|            |       |
|------------|-------|
| EV33675-06 | 6 mm  |
| EV33675-09 | 9 mm  |
| EV33675-13 | 13 mm |
| EV33675-16 | 16 mm |
| EV33675-19 | 19 mm |
| EV33675-25 | 25 mm |
| EV33675-32 | 32 mm |

Meißel  
Chisels  
Cinceles  
Scalpelli



EV33676-02  
9 cm, 3 1/2"  
Spannschlüssel  
Key  
Llave  
Clé  
Chiave



5 mm  
EV33676-05  
8,5 mm, 3.4"



10 mm  
EV33676-10  
8,5 mm, 3.4"



16 mm  
EV33676-16  
8,5 mm, 3.4"



25 mm  
EV33676-25  
8,5 mm, 3.4"

Meißelklingen  
auswechselbar  
Chisel blades  
interchangeable  
Hojas de cincel  
intercambiables  
Lame intercambiabili

EV33676-01  
18,5 cm, 7 1/4"  
Griff allein  
Handle only  
Mango suelto  
Manico solo



5 mm  
EV33677-05  
8,5 mm, 3.4"



10 mm  
EV33677-10  
8,5 mm, 3.4"



16 mm  
EV33677-16  
8,5 mm, 3.4"



25 mm  
EV33677-25  
8,5 mm, 3.4"

Osteotomklingen  
auswechselbar  
Osteotome blades  
interchangeable  
Hojas de osteótomo  
intercambiables  
Lame per osteotomia  
intercambiabili

Sternummeißel, Osteotom, Schädelspalter, Rachiottom, Muskelhaken  
 Sternum Chisel, Osteotome, Skull breaker, Rachiottome, Muscle hooks  
 Cinceles de esternón, Osteotomo, Cincel rompe-cráneo, Raquiótomos, Ganchos musculare  
 Scalpello per sterno, Osteotomo, Divisore per cranio, Rachiotomi, Uncino per muscoli



LEBSCHKE  
 EV33678-24  
 24,5 cm, 9 3/4"



EV33679-13  
 13 cm, 5 1/8"



EV33680-22  
 14 cm, 5 1/2"



EV33682-22  
 22 cm, 8 3/4"



EV19902-10  
 10 cm, 4"



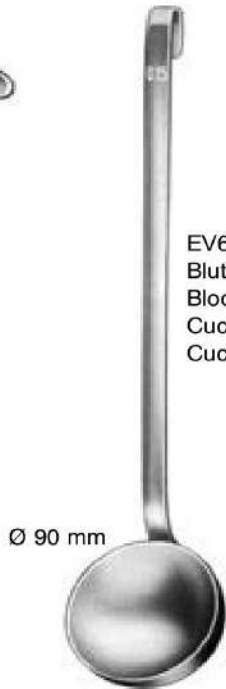
EV19903-00



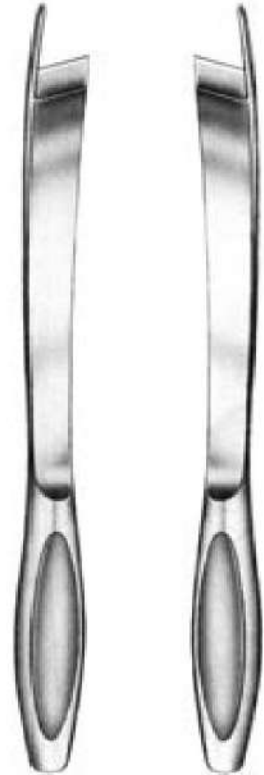
Medizinlöffel, Meißel, Sektionsnadeln  
 Medicine Spoon, Chisels, Post mortem needles  
 Cuchara graduada, Cinceles, Agujas para autopsia  
 Cucchiaino per medicinali, Scalpelli, Aghi per autopsia



EV89146-20 20  
 cc 110 x 20 mm



EV63174-00  
 Blutschöpfer, 150 ccm  
 Blood scoop, 9 cu. inches  
 Cucharra p / sangre  
 Cucchiaino per sangue



BRUNETTI  
 28,5 cm, 11 1/4"  
 EV33682-01 EV33682-02  
 links rechts  
 left right  
 izquierdo derecho  
 sinistra destra

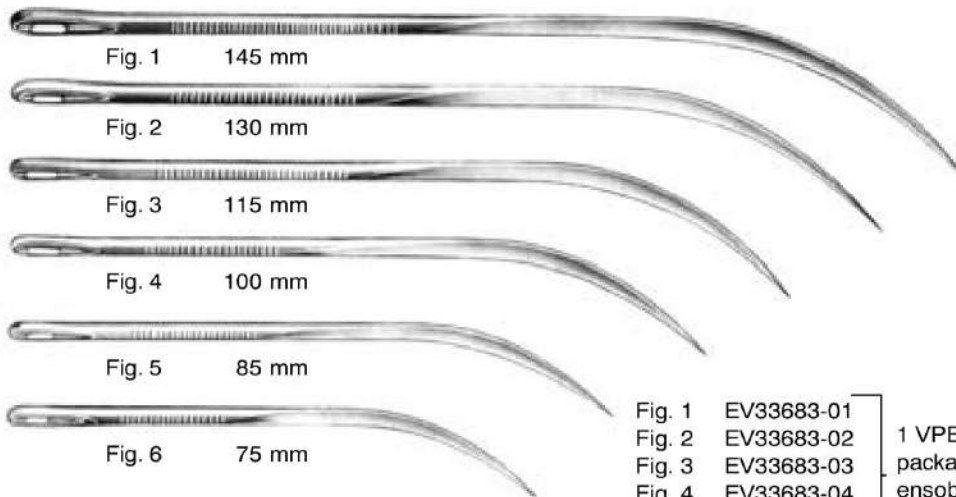


Fig. 1 145 mm

Fig. 2 130 mm

Fig. 3 115 mm

Fig. 4 100 mm

Fig. 5 85 mm

Fig. 6 75 mm

|        |            |  |
|--------|------------|--|
| Fig. 1 | EV33683-01 | } 1 VPE = 12 Stk.<br>package of 12<br>ensobres de 12<br>confezione di 12 |
| Fig. 2 | EV33683-02 |  |
| Fig. 3 | EV33683-03 |  |
| Fig. 4 | EV33683-04 |  |
| Fig. 5 | EV33683-05 |  |
| Fig. 6 | EV33683-06 |  |



EV33684-00

Kleines Besteck, Holzetui, enthaltend:

- 4 Skalpelles
- 1 Knorpelmesser
- 1 Inzisionsschere, 13 cm (5 1/8")
- 1 Anatomische Pinzette, 13 cm (5 1/8")
- 1 Amputationssäge Charrière
- 1 Hammer
- 1 Meißel
- 2 doppelte Muskelhaken
- 2 doppelte Tubuli
- 2 Knopfsonden, 13 cm (5 1/8")
- 3 Wundnadeln

Small set, wooden case, containing:

- 4 Dissecting Knives
- 1 Cartilage Knife
- 1 Incision Scissors, 13 cm (5 1/8")
- 1 Dissecting Forceps, 13 cm (5 1/8")
- 1 Amputation Saw Charrière
- 1 Mallet
- 1 Chisel
- 2 Retractors, double ended
- 2 Blow pipes, double
- 2 Probes, 13 cm (5 1/8")
- 3 Suture Needles

Modelo pequeño, estuche de madera, conteniendo:

- 4 Escalpelos
- 1 Cuchillo para cartilago
- 1 Tijera de incision, 13 cm (5 1/8")
- 1 Pinza para disección, 13 cm (5 1/8")
- 1 Sierra de amputación Charrière
- 1 Martillo
- 1 Escoplo
- 2 Separadores de 2 garfios, dobles
- 2 Tubos insufladores, dobles
- 2 Estiletos olivares, 13 cm (5 1/8")
- 3 Agujas para sutura

Modelo piccolo, astuccio di legno, composto da:

- 4 Bisturi
- 1 Coltello per cartilagine
- 1 Forbice per incisione, 13 cm (5 1/8")
- 1 Pinza anatomica, 13 cm (5 1/8")
- 1 Sega per amputazione, Charrière
- 1 Martello
- 1 Scalpello
- 2 Divaricatori con 2 ganci, doppi
- 2 Tubi inalatori, doppi
- 2 Specilli bottonuti, doppi, 13 cm (5 1/8")
- 3 Aghi per sutura

Ø 25 mm



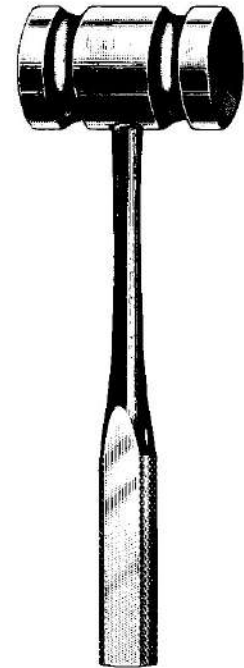
GERZOG  
18 cm, 7"  
EV33686-25 250 g

Ø 38 mm



KIRK  
19 cm, 7 1/2"  
EV33687-75 750 g

Ø 34 mm

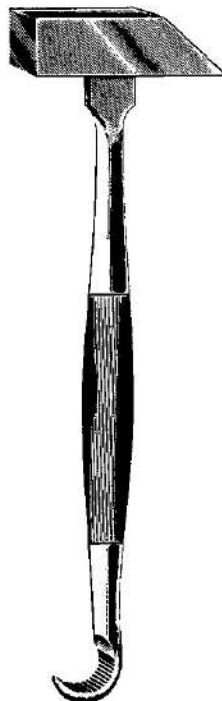


26,5 cm, 10 1/2"  
EV33688-45 450 g  
EV33689-90 900 g

Ø 30 mm

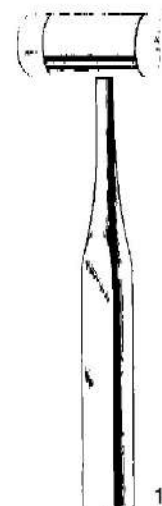


COLLIN  
20 cm, 8"  
EV33690-22 220 g



EV33699-00  
23,5 cm, 9 1/4"  
480 g

Ø 25 mm



135 g  
EV33694-01 18,5 cm, 7 1/4"  
EV33694-03 Ersatzbacken  
Nylon Caps  
Tapas de repuesto  
Placche di ricambio

Hämmer  
Mallets  
Martillos  
Martelli

Ø 26 mm



**WILLIGER**  
24 cm, 9 1/2"  
EV33691-34 340 g

Ø 25 mm



**LUCAE**  
19 cm, 7 1/2"  
EV33692-26 260 g

massiv, mit auswechselbaren Ferrozellbacken  
solid, with interchangeable Ferrozell jaws  
macizo, con tapas intercambiables de Ferrozell  
solido, con placche intercambiabili in Ferrozell

Ø 20 mm

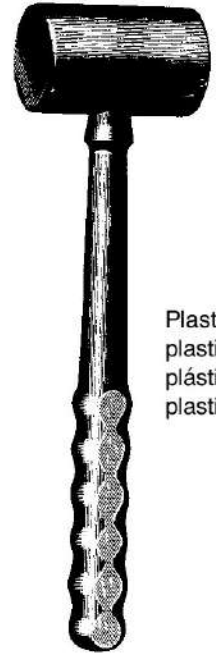


**MEAD**  
17 cm, 6 3/4"  
EV33693-32 320 g

EV33693-33  
Paar Ersatzbacken  
Pair spare jaws  
par de tapas de repuesto  
Coppia di placche di ricambio

EV33693-34  
Satz Ringe  
Set rings  
juego de anillos  
Set anelli

Ø 42 mm



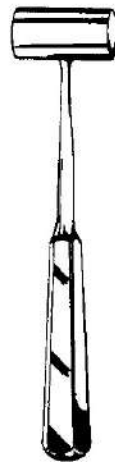
Plastik  
plastic  
plástico  
plastica

26 cm, 10 1/4"  
EV33695-40 400 g



**QUISLING**  
EV33696-75

Ø 22 mm



**PARTSCH**  
EV33698-98  
18 cm, 7"  
199 g

Ø 40 mm



Ø 30 mm

EV33699-17  
26,5 cm, 10 1/2"  
530 g

Ø 30 mm



EV33700-01-01  
Ersatzbacken Nylon Caps  
Tapas de repuesto  
Placche di ricambio

24,5 cm, 9 3/4" 215 g  
EV33700-01

Ø 10 mm



Ø 23 mm

Kopf aus Implantatwerkstoff  
Head made of material used for implants  
Cabeza de material de implantación  
Testa in materiale per impianti

23 cm, 9" 350 g  
EV33700-02

Ø 45 mm



BERGMANN  
24 cm, 9 1/2" 300 g  
EV33700-03

Ø 30 mm



BERGMANN 23  
cm, 9" 300 g  
EV33700-04

Hämmer  
Bone Hammers and Mallets  
Martillos y mazos  
Martelli

Ø 30 mm



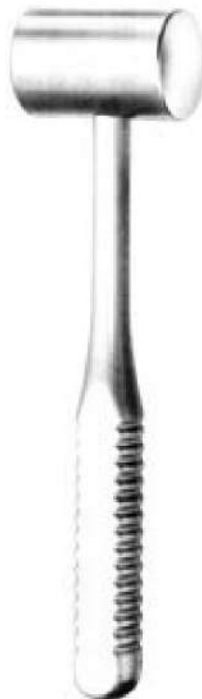
COTTLE  
18 cm, 7" 240 g  
EV33700-05

Ø 40 mm



HEATH  
18 cm, 7" 700 g  
EV33700-06

Ø 40 mm



OMBELGENNNE 25  
cm, 10" 700 g  
EV33700-07

Ø 27 mm



HAJEK  
21 cm, 8 1/4" 140 g  
EV33700-08

Raspatorien  
Periosteal  
Periostótomos  
Periostotomi

12,5 mm



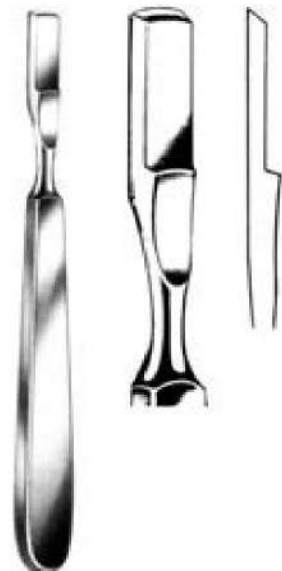
FARABEUF  
EV33702-15  
15 cm, 5.9"

12,5 mm



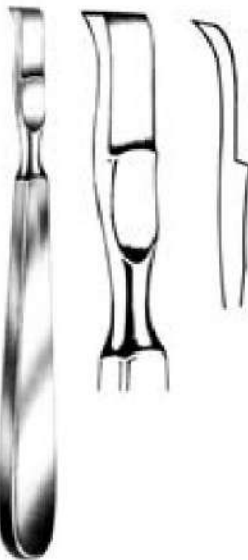
FARABEUF  
EV33703-15  
15 cm, 5.9"

11 mm



FARABEUF-COLLIN  
EV33704-01  
15,5 cm, 6"

11 mm



FARABEUF-COLLIN  
EV33704-02  
15,5 cm, 6"



LAMBOTTE  
21 cm, 8 1/4"  
EV33705-05 5 mm  
EV33705-10 10 mm  
EV33705-15 15 mm  
EV33705-20 20 mm  
EV33705-25 25 mm

18 mm

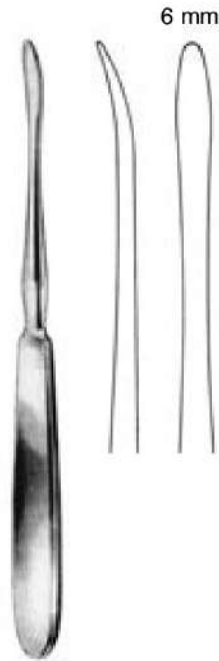


SEDILLOT  
18 cm, 7"  
EV33706-18

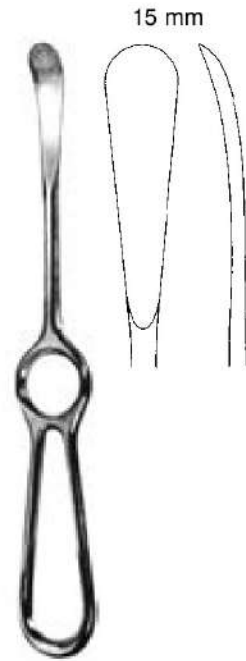
Elevatoren, Raspatorien  
 Elevatoren, Periosteal  
 Elevadores, Periostótomos  
 Elevatori, Periostotomi



SEBILEAU  
 17,5 cm, 7"  
 EV33707-17



QUERVAIN  
 19,5 cm, 7 3/4"  
 EV33708-19



SEDILLOT  
 21 cm, 8 1/4"  
 EV33709-21



LANGENBECK  
 19 cm, 7 1/2"  
 EV33710-19



LANGENBECK  
 18 cm, 7"  
 EV33711-18



LANGENBECK  
 20 cm, 8"  
 EV33711-20 8 mm  
 EV33711-21 10 mm



Raspatorien, Elevatoren  
 Raspatories, Elevators  
 Periostótomos, Elevadores  
 Periostotomi, Elevatori

4 mm



WILLIGER  
 EV33711-16  
 16 cm, 6 1/4"

6,5 mm



WILLIGER  
 EV33712-16  
 16 cm, 6 1/4"

5 mm



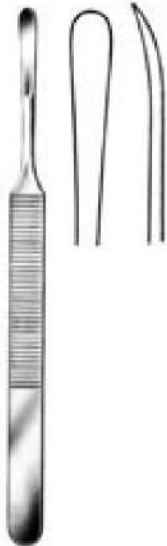
WILLIGER  
 EV33713-16  
 16 cm, 6 1/4"

5,5 mm



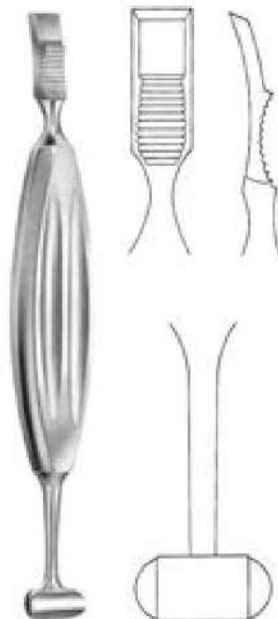
WILLIGER  
 EV33713-17  
 17 cm, 6 3/4"

5 mm



KÖNIG  
 EV33714-15  
 15,5 cm, 6"

12 mm

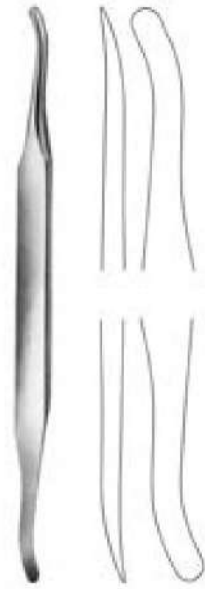


ALEXANDER  
 EV33715-20  
 21 cm, 8 1/4"

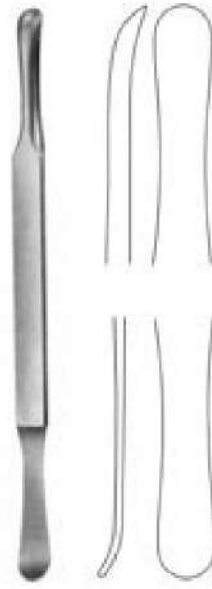


MOLT  
 EV33716-18  
 18 cm, 7"

Raspatorien, Elevatoren, Saugdissektor  
 Raspatories, Elevators, Suction dissector  
 Periostótomos, Elevadores, Disector con aspirador  
 Periostotomi, Elevatori, Dissettore aspiratore



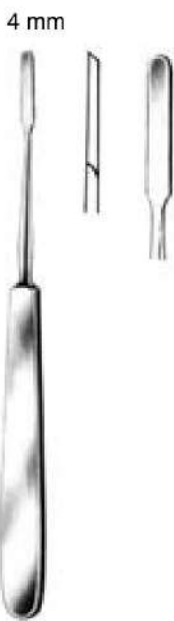
SELDIN  
 EV33717-19-01  
 19,5 cm 7 3/4"



SELDIN  
 EV33717-19-02  
 19,5 cm 7 3/4"



JOSEPH  
 EV33718-16  
 16 cm, 6 1/4"



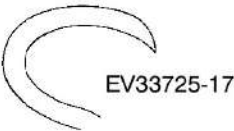
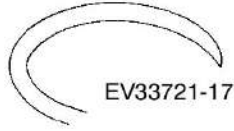
FOMON  
 EV33719-17  
 17 cm, 6 3/4"



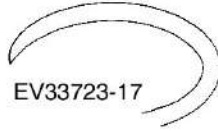
BOIES  
 EV33720-19  
 19 cm, 7 1/2"



GORNEY  
 EV33720-21  
 21 cm, 8 1/4"



L



R



EV33728-24



EV33729-24

DOYEN  
17 cm, 6 3/4"

DOYEN  
17 cm, 6 3/4"

DOYEN  
24 cm 9 1/2"



12 mm



SEMB  
EV33729-01  
17,5 cm  
7"

12 mm



EV33729-02  
21 cm  
8 1/4"

12 mm



EV33729-03  
17,5 cm  
7"

13 mm



EV33729-04  
21 cm  
8 1/4"

15 mm

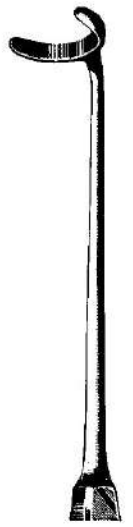


EV33729-05  
20,5 cm  
8"

15 mm

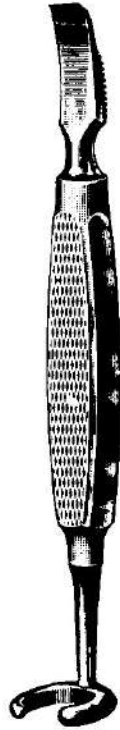


EV33729-06  
20,5 cm  
8"

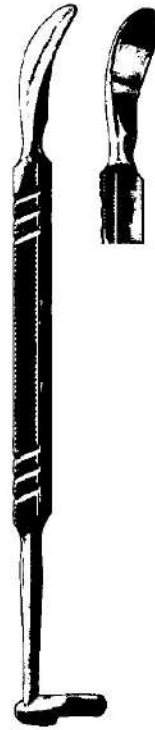


EV33729-07  
22,5 cm  
8.9"

Elevatoren, Raspatoren  
Elevators, Raspatories  
Elevadores, Periostótomos  
Elevatori, Periostotomi



MATSON-ALEXANDER  
EV33731-22  
22 cm, 8 3/4"



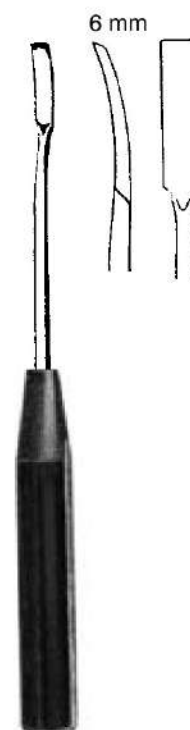
MATSON  
EV33733-22  
22 cm, 8 3/4"



EV33740-19  
19 cm, 7 1/2"



EV33741-18  
18,5 cm, 7 1/4"



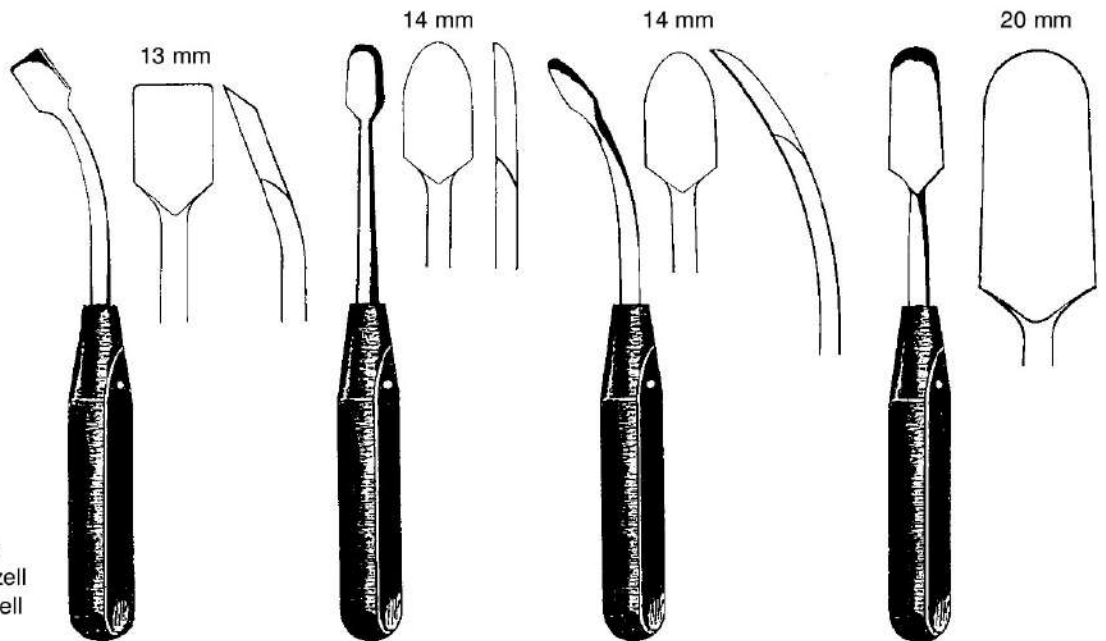
EV33742-18  
18,5 cm, 7 1/4"



EV33743-18  
18,5 cm, 7 1/4"

mit Ferrozellgriff  
with Ferrozell-Handle  
con mango de Ferrozell  
con manico di Ferrozell

Elevatoren, Raspatoren  
Elevators, Raspatories  
Elevadores, Periostótomos  
Elevatori, Periostotomi



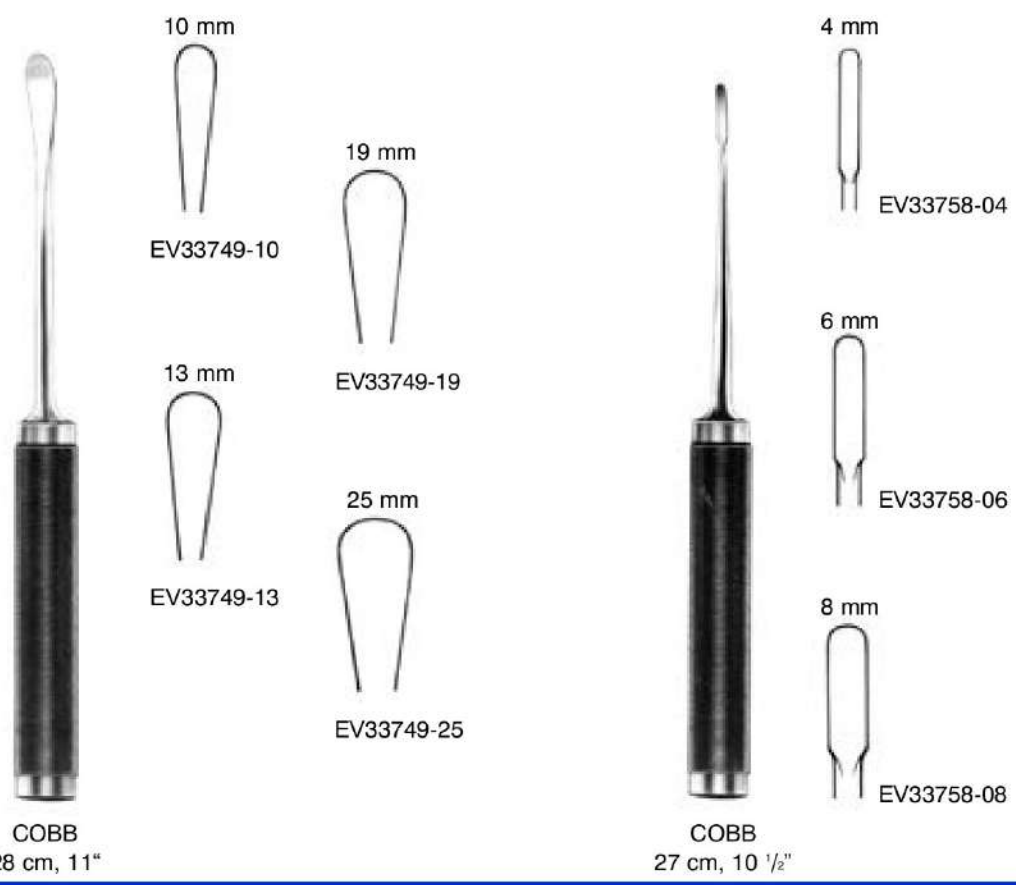
mit Ferrozellgriff  
with Ferrozell-Handle  
con mango de Ferrozell  
con manico di Ferrozell

EV33745-19  
18,5 cm, 7 1/4"

EV33746-19  
19,5 cm, 7 3/4"

EV33747-18  
18,5 cm, 7 1/4"

EV33748-20  
20 cm, 8"



10 mm  
EV33749-10

19 mm  
EV33749-19

13 mm  
EV33749-13

25 mm  
EV33749-25

4 mm  
EV33758-04

6 mm  
EV33758-06

8 mm  
EV33758-08

COBB  
28 cm, 11"

COBB  
27 cm, 10 1/2"

scharf  
sharp  
cortante  
tagliente



SAYRE 17  
cm, 6 <sup>3</sup>/<sub>4</sub>"  
EV33758-01

stumpf  
blunt  
romo  
smusso

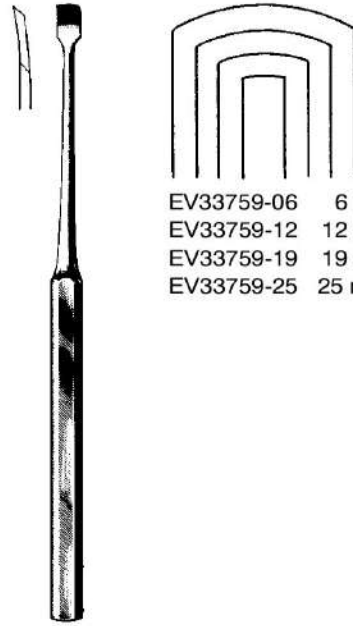


SAYRE 17  
cm, 6 <sup>3</sup>/<sub>4</sub>"  
EV33758-02

Raspatoren, Knochenhebel, Dissektor  
 Raspatories, Bone Levers, Dissectors  
 Periostótomes para huesos, Disectores  
 Periostotomi, Elevatori per ossa, Dissettori



ADSON  
 17 cm, 6 3/4"

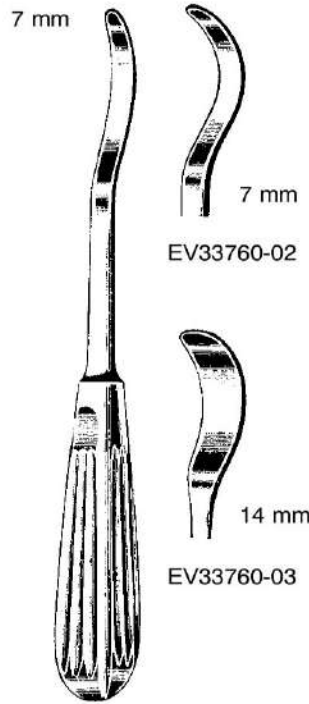


EV33759-06 6 mm  
 EV33759-12 12 mm  
 EV33759-19 19 mm  
 EV33759-25 25 mm

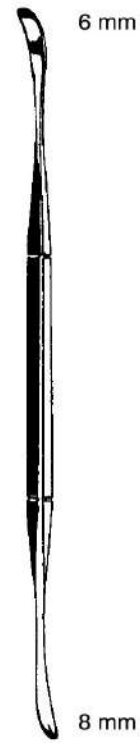
KEY  
 EV33759-06 - EV33759-25  
 19 cm, 7 1/2"



CHANDLER  
 EV33763-01 19,0 cm 7 1/2"  
 EV33763-02 20,3 cm 8"  
 EV33763-03 22,9 cm 9"  
 EV33763-04 25,4 cm 10"

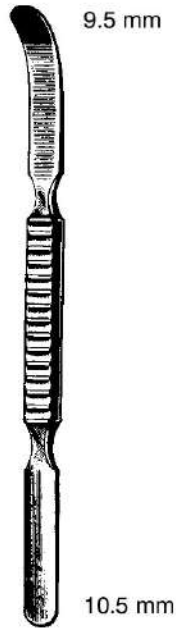


CREGO  
 EV33760-01  
 20 cm, 8"

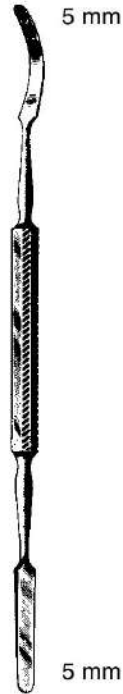


ALDERDYCE  
 EV33761-21  
 21 cm, 8 1/4"

Elevatoren, Dissektor, Knochenheber  
Elevators, Dissectors, Bone Levers  
Elevadores para huesos, Disectores  
Elevatori, Dissettori, Elevatori per ossa



WATSON-CHEYNE  
EV33765-17 17,5  
cm, 7"



MC DONALD  
EV33767-19  
19 cm, 7 1/2"



MURPHY-LANE  
EV33769-30  
30 cm, 11 3/4"



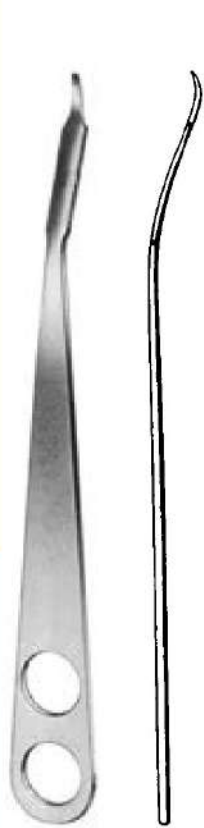
BENNETT  
EV33771-71  
26 cm, 10 1/4"



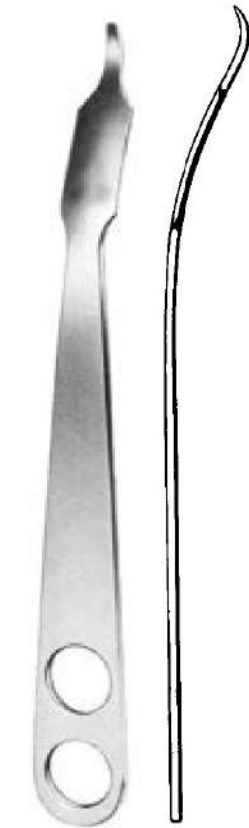
BENNETT  
EV33771-73  
26 cm, 10 1/4"



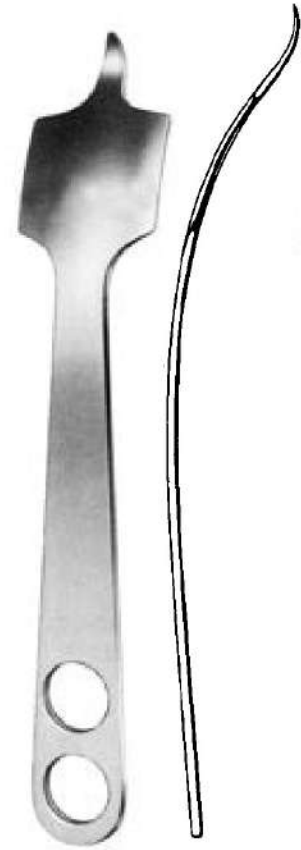
Knochenhebel  
 Bone Levers  
 Elevadores para huesos  
 Elevatori per ossa



HOHMANN  
 EV33801-08 8 mm  
 EV33801-12 12 mm



HOHMANN  
 EV33801-18  
 18 mm, 3/4"



HOHMANN  
 EV33801-43  
 43 mm, 1 3/4"



HOHMANN  
 EV33801-70  
 70 mm, 2 3/4"



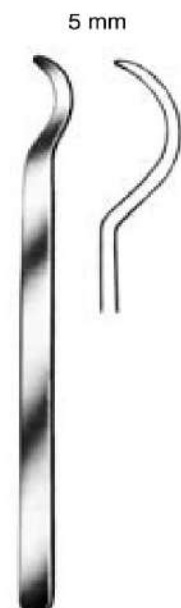
KÖNIG  
 EV33802-01  
 15 cm, 6"



KÖNIG  
 EV33802-02  
 15 cm, 6"



EV33802-14  
 14 cm, 5 1/2"



EV33803-05  
 15 cm, 6"

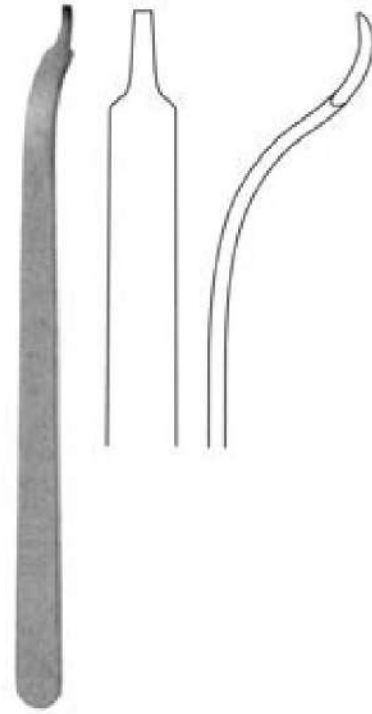


EV33803-07  
 15 cm, 6"

Knochenhebel  
 Bone Levers  
 Elevadores para huesos  
 Elevatori per ossa



HOHMANN EV33803-43  
 43 mm



BUCK-GRAMCKO  
 EV33804-15 7,5 mm



HOHMANN  
 EV33805-22 22 mm



HOHMANN  
 EV33805-33 33 mm

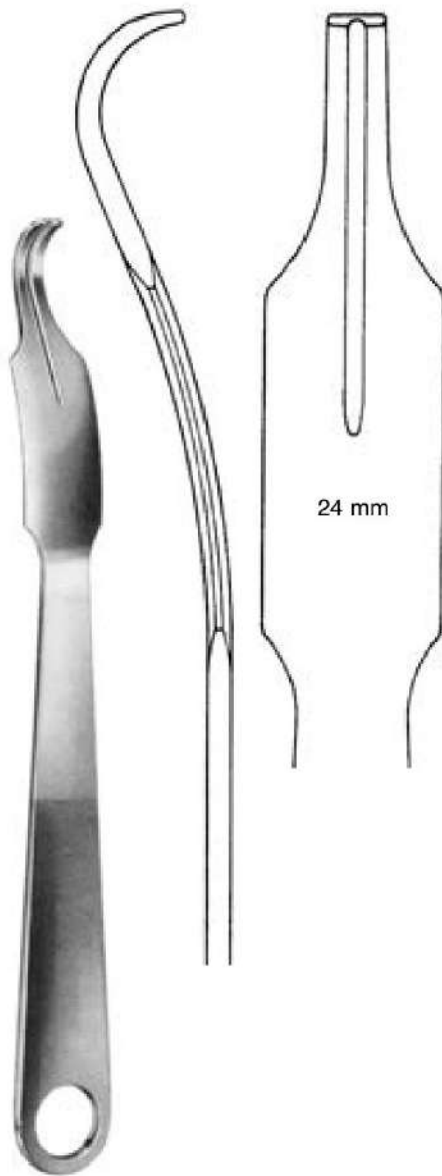


HOHMANN EV33807-24  
 24 mm



HOHMANN  
 EV33809-22 22 mm

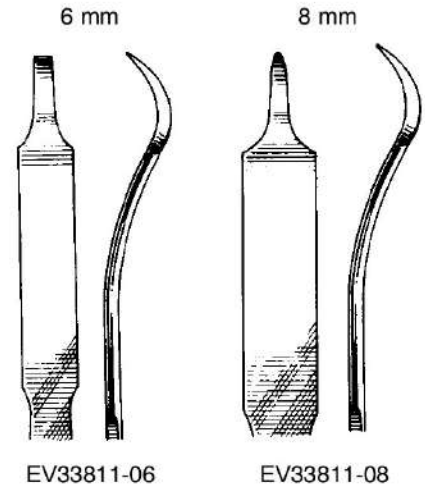
Knochenheber  
Bone Levers  
Elevadores para huesos  
Elevatori per ossa



LANGE-HOHMANN  
EV33810-24  
25 cm, 10"

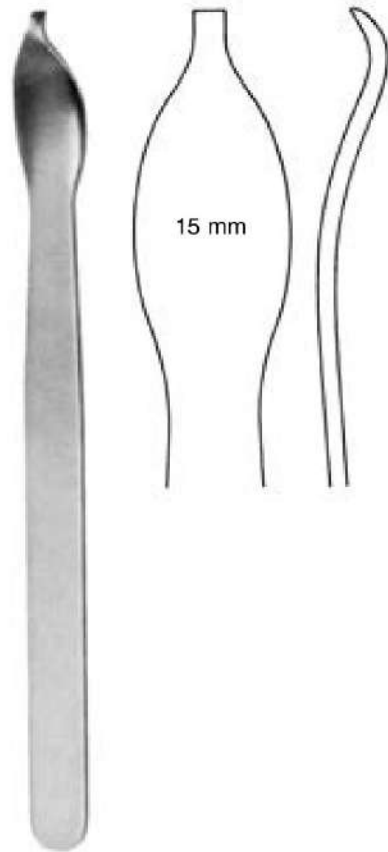


HOHMANN mini  
16 cm, 6 1/4"

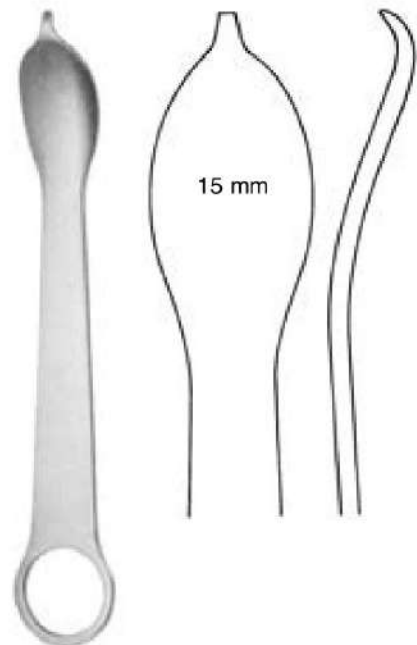


EV33811-06

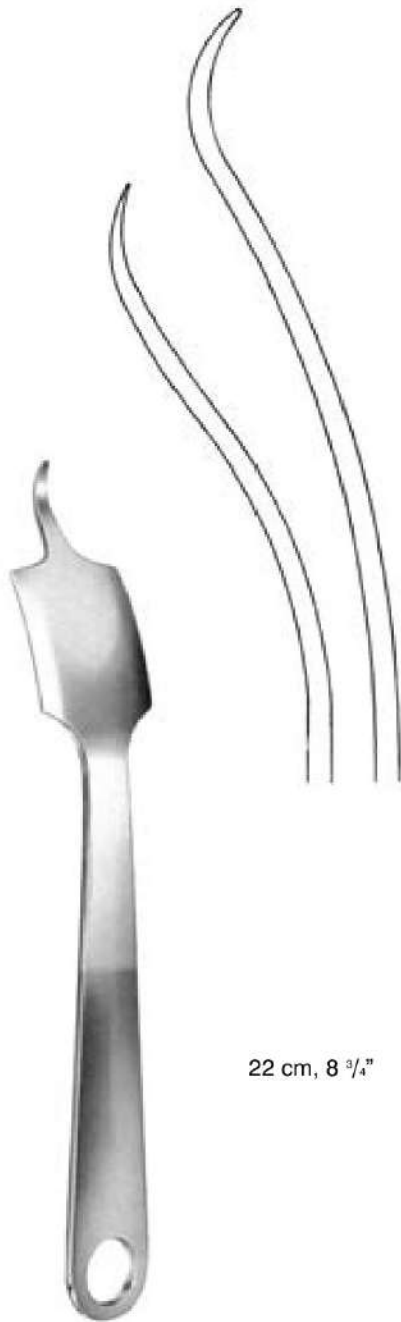
EV33811-08



EV33812-16  
16 cm, 6 1/4"



EV33813-12  
12 cm, 4 3/4"

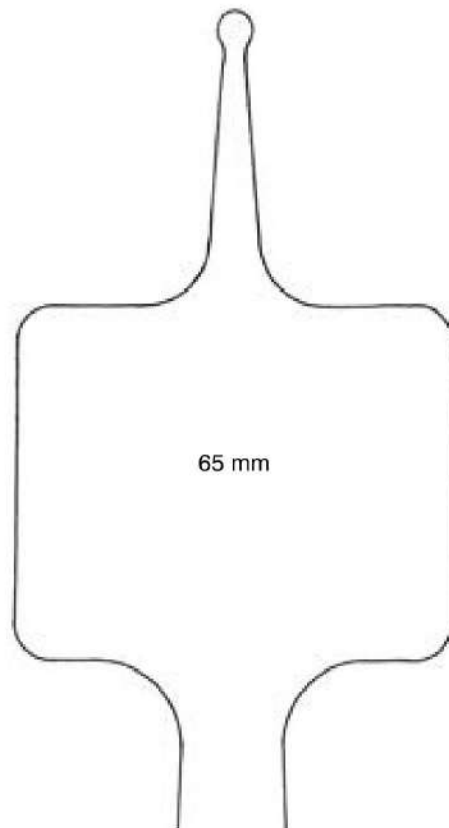


22 cm, 8 <sup>3</sup>/<sub>4</sub>"

VERBRUGGE-MÜLLER  
EV33814-44 24,0 cm, 9 <sup>1</sup>/<sub>2</sub>"  
EV33814-65 25,5 cm, 10"



44 mm



65 mm

Knochenhebel  
Bone Levers  
Elevadores para huesos  
Elevatori per ossa

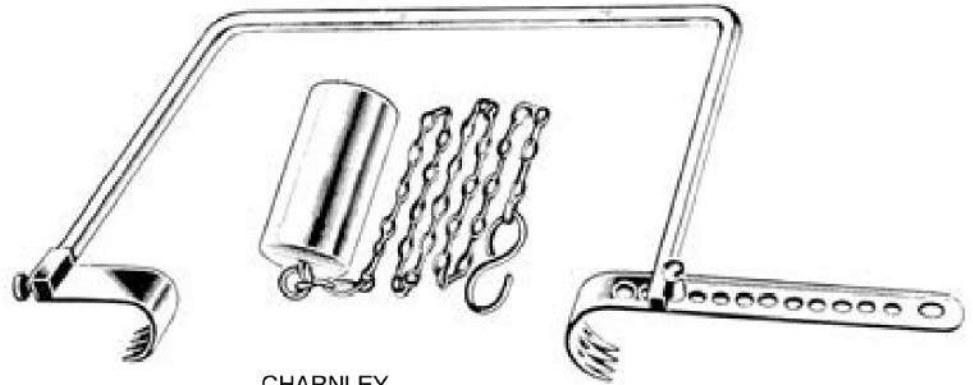


BLOUNT  
EV33823-26  
26 cm, 10 1/4"



BLOUNT  
EV33825-26  
26 cm, 10 1/4"

Retraktor, Knochenhebel, Meniskushaken  
 Retractor, Bone Levers, Meniscus Retractors  
 Separador, Elevadores p. huesos, Separadores para menisco  
 Divaricatori, Elevatori per ossa, Divaricatori per il menisco



CHARNLEY  
EV33826-00

EV33826-01

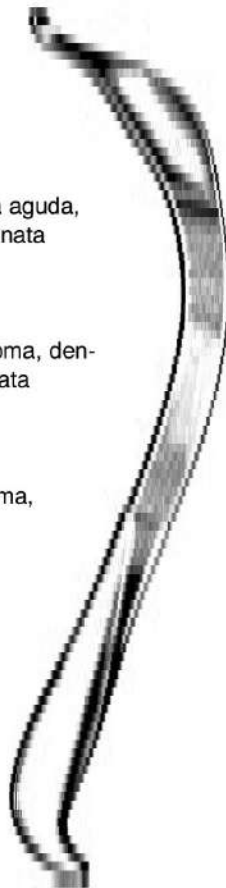
spitz, gerieft  
 pointed tip, serrated punta aguda,  
 dentada punta acuta, zigrinata

EV33826-02

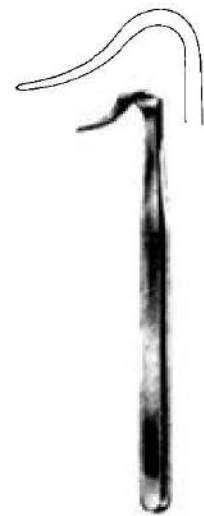
stumpf, gerieft  
 blunt tip, serrated punta roma, den-  
 tada punta smussa, zigrinata

EV33826-03

stumpf, glatt  
 blunt tip, smooth punta roma,  
 lisa punta smussa, liscia



AUFRANC-COBRA  
26 cm 10 1/4"



BLOUNT  
EV33827-17  
17,5 cm 7"

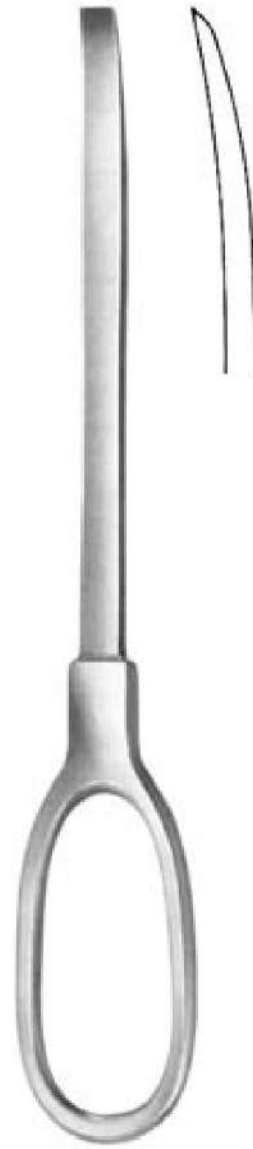
Knochenhebel  
Bone Levers  
Elevadores p. huesos  
Elevatori per ossa



LANE TRETOWAN  
EV33828-21  
21,5 cm 8 1/2"



LANE  
EV33829-25  
25,5 cm 10"



BRISTOW  
EV33830-23  
23 cm 9"



Knochenhebel, Meniskushaken  
 Bone Levers, Meniscus Retractors  
 Elevadores p. huesos, Separadores para menisco  
 Elevatori per ossa, Divaricatori per il menisco



TAYLOR  
 16,5 cm, 6 1/2"  
 EV33831-16 75x30 mm  
 EV33833-16 100x30 mm



SMILLIE 14  
 cm, 5 1/2" 12 x  
 13 mm  
 EV33832-01



SMILLIE 14  
 cm, 5 1/2" 52 x  
 13 mm  
 EV33832-02



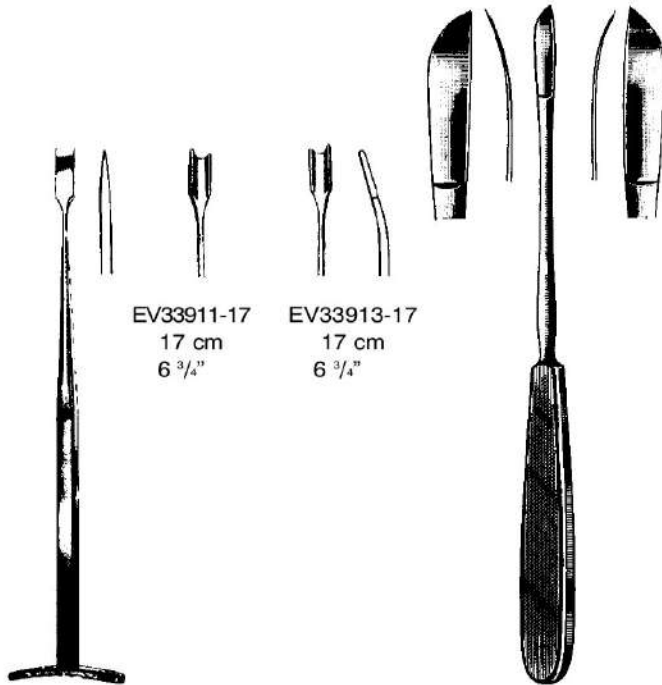
SMILLIE  
 14 cm, 5 1/2"

32 x 19 mm  
 EV33832-03

48 x 19 mm  
 EV33832-04

57 x 19 mm  
 EV33832-05

Sehenschäler, Sehnenfaßpinzette, Sehnenhaltezange, Sehnenfaßinstrumente  
 Tendon seizing instruments  
 Instrumentos para coger tendones  
 Enucleatore di tendine, Strumenti per afferrare tendini








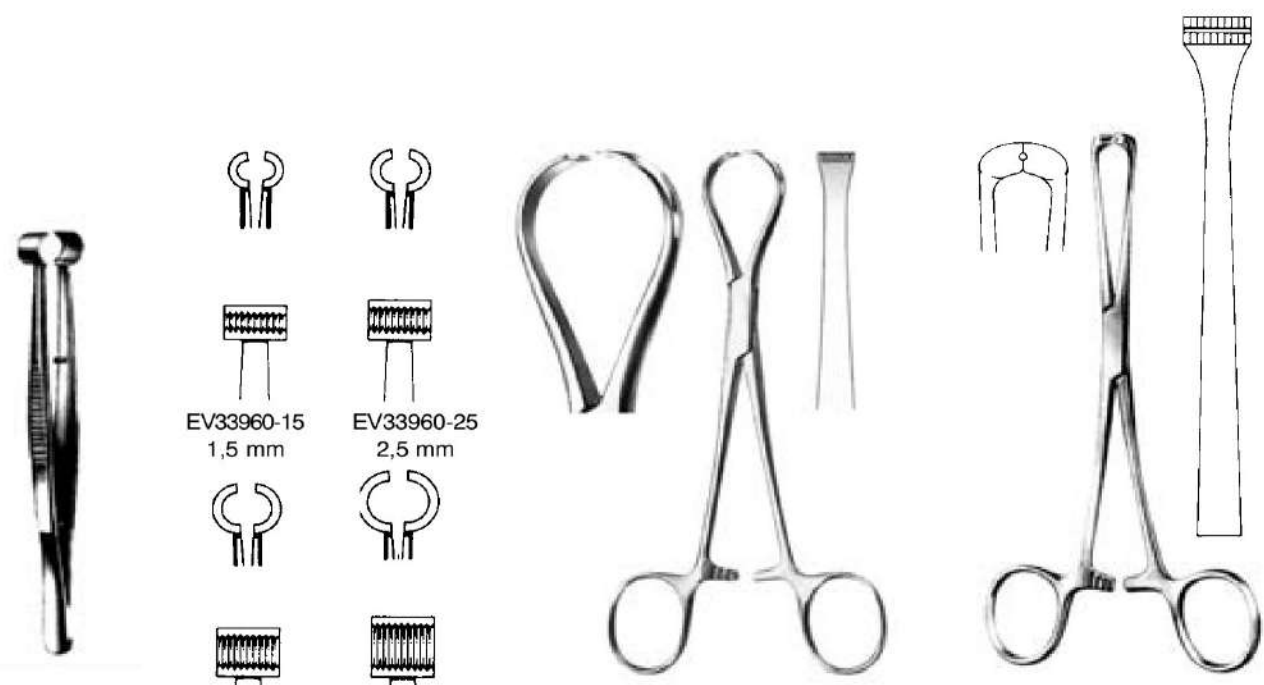
**SMILLIE**  
 EV33910-17  
 17 cm, 6 3/4"

EV33911-17 17 cm 6 3/4"  
 EV33913-17 17 cm 6 3/4"

**NEFF**  
 EV33921-22 - EV33923-22  
 22 cm, 8 3/4"

**BUNELL**  
 EV33950-01 - EV33950-05  
 15 cm, 6"

-  EV33950-01 3 mm
-  EV33950-02 4 mm
-  EV33950-03 5 mm
-  EV33950-04 6 mm
-  EV33950-05 7 mm



**LARSEN**  
 3960-15 - EV33960-55  
 10 cm, 4"

EV33960-15 1,5 mm  
 EV33960-25 2,5 mm  
 EV33960-45 4,5 mm  
 EV33960-55 5,5 mm

**JACKSON**  
 EV33961-15  
 15 cm, 6"

**STEINMANN**  
 EV33962-16  
 16 cm, 6 1/4"

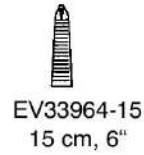
Sehnenfaßinstrumente, Sehnenführer  
 Tendon seizing instruments, Tendon passing instr.  
 Instrumentos para coger tendones, Instrumento p. el tunel del tendon  
 Strumenti per afferrare tendini



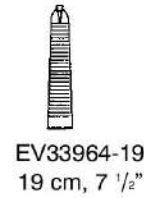
EV33963-12  
 12 cm, 4 3/4"



BRAND  
 EV33964-15 - EV33964-24



EV33964-15  
 15 cm, 6"



EV33964-19  
 19 cm, 7 1/2"



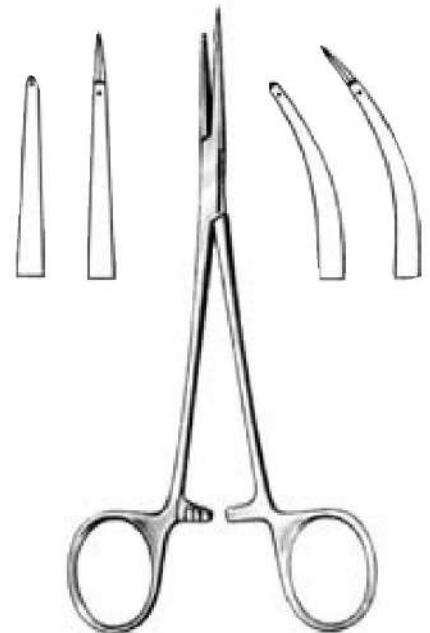
EV33964-24  
 24 cm, 9 1/2"



BRAND  
 EV33965-15 15 cm, 6"  
 EV33965-19 19 cm, 7 1/2"  
 EV33965-24 24 cm, 9 1/2"



CAROLL  
 EV33966-11  
 11 cm, 4 3/8"



EV33966-15 15 cm, 6" EV33967-15

Sehnenfassinstrumente, Sehnenstripper, Knochenfeilen, Raspeln  
 Tendon seizing instruments, Tendon Strippers, Bone Files, Rasps  
 Instrumentos para coger tendones, Enucleadores de tendones, Limas, Escofinas  
 Strumenti per afferrare tendini, Scollatendini, Lime per ossa, Raspe



KLEINERT-KUTZ  
 EV33967-20  
 20 cm, 8"



BRAND

ø 3 mm



EV33968-30  
 30 cm, 11 3/4"

ø 6 mm



EV33968-60  
 50 cm, 19 1/2"



biegsam  
 malleable  
 maleable  
 malleabile

BUNELL

EV33969-18 18 cm, 7"  
 EV33969-23 23 cm, 9"



biegsamer Schaft  
 flexible shaft  
 vástago maleable  
 camicia flessibile

BUNELL 23 cm

EV33970-01 ø 4,0 mm  
 EV33970-02 ø 4,5 mm  
 EV33970-03 ø 5,5 mm



EV33971-24  
 24,5 cm, 9 3/4"



EV33972-22  
 22 cm, 8 3/4"



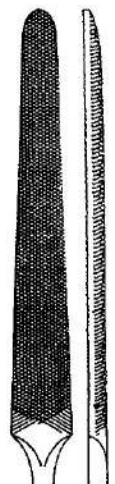
PUTTI  
 EV33973-27  
 27 cm, 10 1/2"



PUTTI  
 EV33975-30  
 30 cm, 11 3/4"



EV33977-28  
 28 cm, 11"





EV34101-01  
compl.

Gerät zur Erzeugung von Blutleere in den Gliedmaßen  
Compression Apparatus for producing blood vacuum in limbs  
Aparato de compresión para producir el vacío de sangre en los miembros  
Vacumentro per determinare vuoti di sangue nelle membra

EV34101-02  
Pumpe  
Air Pump  
Bomba de aire  
Pompa di aria

EV34101-03  
Manometer  
Manometer  
Manómetro  
Manometro

EV34101-04 Ober-  
armmanschette Cuff  
for upper arm  
Brazalete (brazo)  
Bracciale  
EV34101-06 incl.

EV34101-05 Ober-  
schenkelmanschette Cuff  
(leg)  
Brazalete (pierna)  
Cosciale  
EV34101-07 incl.

EV34101-06  
Polster für Oberarmmanschette 46 x 6 cm (18" x 2.4")  
Bandage cuff for arm 46 x 6 cm (18" x 2.4")  
Colchon para brazalete para brazo 46 x 6 cm (18" x 2.4")  
Bracciale per braccio superiore 46 x 6 cm (18" x 2.4")

EV34101-07  
Polster für Oberschenkelmanschette 55 x 10 cm (21 1/2 x 10")  
Bandage cuff for leg 55 x 10 cm (21 1/2 x 10")  
Colchon para brazalete para el femur 55 x 10 cm (21 1/2 x 10")  
Bracciale per coscia superiore 55 x 10 cm (21 1/2 x 10")

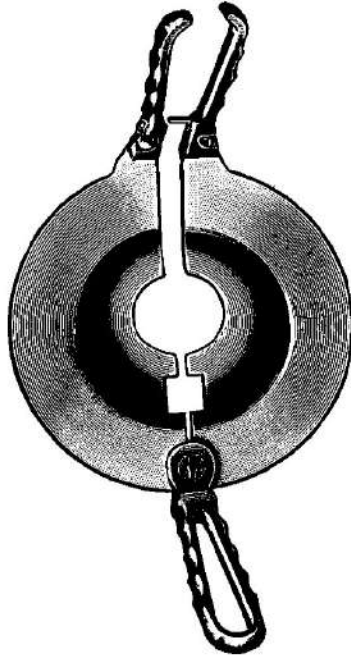
Amputations- und Resektionssägen  
 Amputation and Resection Saws  
 Sierras para amputación y resección  
 Seghe per amputazione e resezione

GERNAL SURGICAL

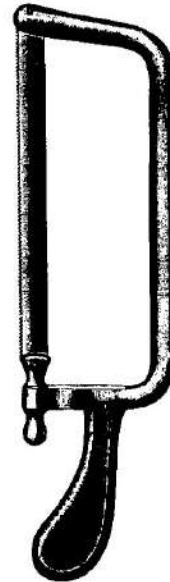
Staubbinde  
 Compression bandage  
 Vendaje de compresión  
 Benda per compressione  
 5 m lang / long  
 6 cm breit / wide



ESMARCH  
 EV34105-01



PERCY  
 EV34110-00



CHARRIERE  
 EV34112-00  
 35 cm, 13 3/4"

EV34112-01  
 12 mm

Ersatzsägeblätter  
 Spare saw blades  
 Hojas de sierra de  
 repuesto  
 Lame di ricambio

EV34112-02  
 15 mm

Ersatzsägeblätter  
 Spare saw blades  
 Hojas de sierra de  
 repuesto  
 Lame di ricambio

komplett mit 2 Blättern  
 complete with 2 blades  
 completo con 2 hojas  
 completa con 2 lame

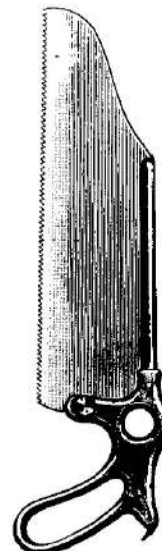


mit 3 Sägeblätter  
 4 - 6 - 8 mm  
 with 3 spare blade  
 con 3 hojas de repuesto  
 con 3 lame di ricambio

BIER  
 EV34114-39  
 40,5 cm, 16"



CHARRIERE  
 EV34116-30  
 30 cm, 11 3/4"



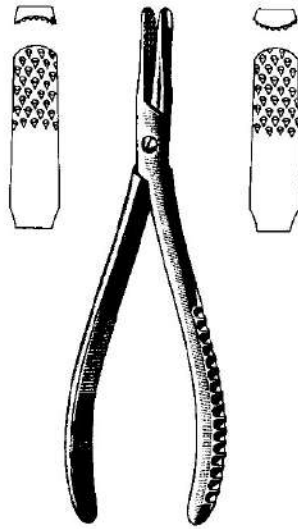
SATTERLEE  
 EV34118-31  
 31 cm, 12 1/4"

EV34118-99  
 Sägeblatt  
 blade hoja  
 lama



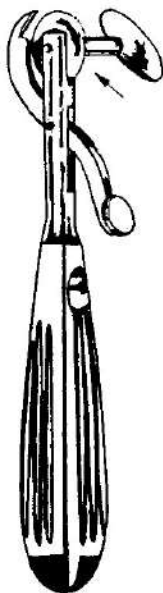
LANGENBECK  
 EV34120-23  
 23 cm, 9"

Nagelausreißzange, Fingerringsägen  
 Fcps. f. tearing out finger nails, Finger Ring Saws  
 Pinzas para arrancar uñas, Sierras para abrir anillos  
 Pinze per lacerazione delle unghie, Seghe per anelli



**RADOLF**

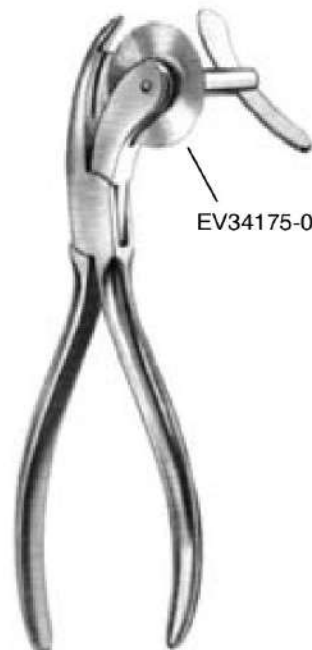
EV34161-13 13,5 cm, 5 1/4" 3 mm  
 EV34162-13 13,5 cm, 5 1/4" 6 mm



**WALTON**  
 EV34172-00  
 16 cm, 6 1/4"

Sägeblatt  
 Saw blade  
 Hoja de sierra  
 Lama di ricambio

EV34172-01

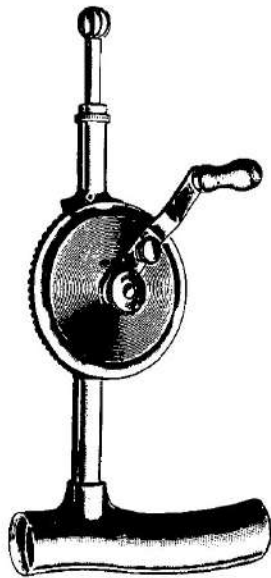


**ELGEN**  
 EV34175-00  
 17 cm, 6 3/4"

Sägeblatt  
 Saw blade  
 Hoja de sierra  
 Lama di ricambio

EV34175-01

Bohrapparate, Bohrlochzange  
 Bone Hand Drills, Forceps for Bone Hole  
 Perforador de mano, Pinza de guía  
 Perforatori a mano, Pinza per perforazione



**STILLE**  
 EV34210-20 20 cm, 8" compl. incl.  
 EV34212-25 - EV34214-16



EV34212-25  
 2,5 mm



EV34212-30  
 3,0 mm



EV34212-35  
 3,5 mm



EV34212-40  
 4,0 mm



EV34214-05  
 10 mm



EV34214-08  
 5 mm



EV34214-10  
 8 mm



EV34214-12  
 12 mm



EV34214-16  
 16 mm



EV34216-10  
 1,0 mm



EV34216-15  
 1,5 mm



EV34216-20  
 2,0 mm



EV34222-25  
 2,5 mm



EV34222-30  
 3,0 mm



EV34222-35  
 3,5 mm



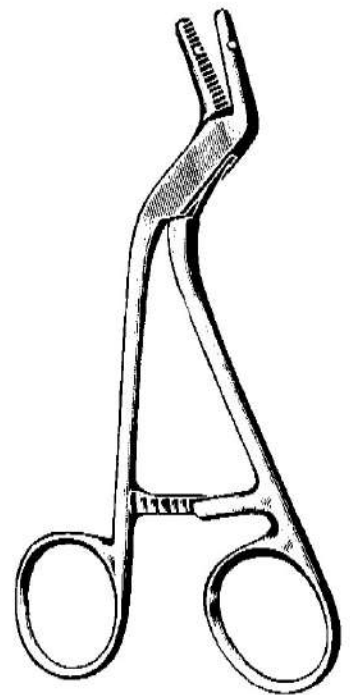
EV34232-00  
 Ø 3,2 mm



**STILLE-SHERMAN**  
 EV34220-24 24 cm, 9 1/2" compl.  
 incl. EV34222-25 - EV34222-35



**MOORE**  
 EV34230-28 28 cm, 11"  
 compl. incl. EV34232-00



**ADSON**  
 EV34231-15  
 15 cm, 6"



Bohrapparate  
Bone Hand Drills  
Perforador de mano  
Perforatori a mano

GERNAL SURGICAL



EV34241-00  
Griff allein  
Handle only  
Mango solo  
Manico solo

HUDSON  
EV34240-27 27 cm, 10 1/2" compl.  
incl. EV34242-09, -14, -16, -22,  
EV34246-00



EV34242-09  
9 mm



EV34242-14  
14 mm



EV34242-16  
16 mm



EV34242-22  
22 mm



ø 2 mm  
EV34243-02



CUSHING  
EV34244-10  
EV34244-14  
EV34244-16



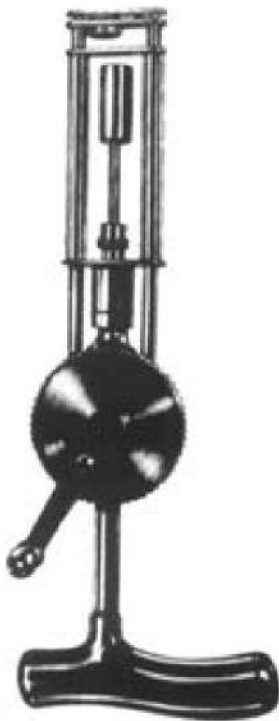
ERRICO  
EV34244-17  
ø 16 mm



MC KENZIE  
EV34248-00  
ø 13 mm



EV34246-00  
Verlängerungsstück  
Extension piece  
Pieza alargadera  
Giunto di prolungamento



KIRSCHNER  
EV34250-00 compl.



EV34252-00



BUNELL  
EV34270-00 16 cm, 6 1/4"

EV34270-01  
Schlüssel  
Wrench  
Llave  
Chiave

Bohrapparat 16 cm (6 1/4"), längsdurchbohrt mit Dreibackenspannfutter und Schlüssel, Spannweite bis 4 mm  
Hand drill, 16 cm (6 1/4"), longitudinally bored, with three-jaw-chuck and key, opening up to 4 mm  
Perforador manual, 16 cm (6 1/4"), taladrado longitudinalmente, con mandril de tres mordazas y llave, abriendo hasta 4 mm  
Perforatore a mano, 16 cm (6 1/4"), con perforazione assiale, con mandrino a tre ganasce e chiave, apertura fino a 4 mm di D.

Bohrapparate, Handgriffe  
Bone Hand Drills, Handles  
Perforador de mano  
Perforatori a mano, manici



RALK  
EV34280-00



ELGEN  
EV34290-00



EV34295-00

Spannschlüssel allein  
Key only  
Llave suelta  
Chiave solo



EV34296-00

Handgriff mit Jacobs-  
spannfutter und Spann-  
schlüssel bis 3,6 mm  
Handle with Jacobs chuck  
and key to 3,6 mm  
Mango con cierre Jacobs,  
de 3 mordazas y llave a  
3,6 mm  
Manico con mandrino di  
Jacobs e chiave a 3,6 mm

Bohrapparat mit Leichtmetallgehäuse, mit Dreibackenspannfutter und Schlüssel, Spannweite bis D. 6,35 mm  
Hand drill with light metal case, with three-jaw-chuck and key, opening up to D. 6,35 mm  
Perforador manual con caja de aluminio, con mandril de tres mordazas y llave, abriendo hasta 6,35 mm de D.  
Perforatore a mano con cassa in metallo leggero, con mandrino a tre ganasce e chiave, apertura fino a 6,35 mm di D.

Handbohrapparat mit umstellbarem Handgriff, mit Jacobs Dreibackenspannfutter und Schlüssel  
Hand drill with adjustable handle, with Jacobs three-jaw-chuck and wrench  
Perforador de mano en T con cierre Jacobs de 3 mordazas y llave de ajuste  
Perforatore a mano con manico regolabile, con mandrino a tre ganasce di Jacobs e chiave



EV34296-05 T-

Handgriff, verriegelbares schlüsselloses Dreibackenspannfutter, rostfrei T-handle, keyless locking chuck  
Mango en T, mordaza sin llave, inox.  
Chiave a T con mandrino a tre ganasce inox



EV34296-10

Handgriff, Dreibackenspannfutter, inkl. Spannschlüssel rostfrei  
Handle with chuck, including key  
Mango, mordaza incluyendo llave, inox. Mandrino a tre ganasce con manico retto completo di chiave di arresto inox



EV34296-15

"Hudson" T-Handgriff, Schnellkupplung Hudson T-handle with fast gripping chuck  
Mango en T, acople rápido  
Hudson: mandrino con manico a T  
Ganasce con raccordo rapido



EV34296-20

Schnellkupplungs T-Handgriff, groß  
T-handle with fast gripping chuck, large  
Mango en T, acople rápido, grande  
Mandrino a T manico grande  
Raccordo rapido

Schnellkupplungs-Handgriffe  
 Handles with quick-action chuck  
 Mangos de acople rápido  
 Manici con attachi rapidi



EV34296-25 Schnellkupplungs-T-Handgriff T-Handle, quick-action  
 Mango en T, acople rápido Mandrino a T con raccordo rapido



EV34296-30 Schnellkupplungs-Handgriff groß mit Hartgewebegriff Handle, quick-action, large, handle made of very hard fibre  
 Mango de acople rápido, grande, de material extraduro Mandrino grande rapido con manico a fibre dure



EV34296-35 Schnellkupplungs-Handgriff mit Hartgewebegriff Handle, quick-action, made of very hard fibre  
 Mango de acople rápido, de material extraduro Mandrino medio rapido con manico a fibre dure



EV34296-40 Mini Schnellkupplungs-Handgriff für „Dental“-Anschluß Mini-Handle, quick-action, "dental"  
 Mini-Mango de acople rápido "dental"  
 Mini mandrino-rapido con impugnatura cilindrica con attacco dentale



| Ø      |        |            |
|--------|--------|------------|
| 1,0 mm | 56 mm  | EV34320-10 |
| 1,5 mm | 70 mm  | EV34320-15 |
| 2,0 mm | 85 mm  | EV34320-20 |
| 2,5 mm | 95 mm  | EV34320-25 |
| 2,7 mm | 100 mm | EV34320-27 |
| 3,0 mm | 100 mm | EV34320-30 |
| 3,2 mm | 106 mm | EV34320-32 |
| 3,5 mm | 112 mm | EV34320-35 |
| 4,0 mm | 119 mm | EV34320-40 |
| 4,5 mm | 126 mm | EV34320-45 |
| 5,0 mm | 132 mm | EV34320-50 |
| 6,0 mm | 139 mm | EV34320-60 |
| 7,0 mm | 156 mm | EV34320-70 |

Spiralbohrer mit Glattschaft  
Twist Drills with round end  
Taladros espirales con vástago redondo  
Perforatore elicoidale



| Ø       |        |            |
|---------|--------|------------|
| 1,0 mm  | 180 mm | EV34321-10 |
| 1,5 mm  | 180 mm | EV34321-15 |
| 2,0 mm  | 180 mm | EV34321-20 |
| 2,5 mm  | 180 mm | EV34321-25 |
| 2,7 mm  | 180 mm | EV34321-27 |
| 3,0 mm  | 180 mm | EV34321-30 |
| 3,2 mm  | 180 mm | EV34321-32 |
| 3,5 mm  | 180 mm | EV34321-35 |
| 4,0 mm  | 180 mm | EV34321-40 |
| 4,5 mm  | 180 mm | EV34321-45 |
| 5,0 mm  | 180 mm | EV34321-50 |
| 6,0 mm  | 180 mm | EV34321-60 |
| 6,5 mm  | 180 mm | EV34321-65 |
| 7,0 mm  | 180 mm | EV34321-70 |
| 8,0 mm  | 180 mm | EV34321-80 |
| 9,0 mm  | 180 mm | EV34321-90 |
| 10,0 mm | 180 mm | EV34322-00 |

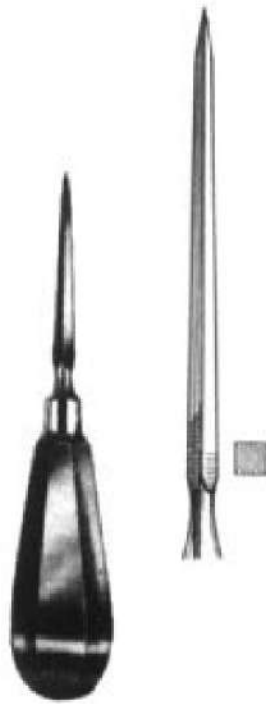
Spiralbohrer mit Glattschaft langes Modell  
Twist Drills, long typ  
Taladros espirales, largos  
Perforatore elicoidale, modello lungo



| Ø      |        |            |
|--------|--------|------------|
| 1,1 mm | 60 mm  | EV34322-11 |
| 1,5 mm | 85 mm  | EV34322-15 |
| 2,0 mm | 100 mm | EV34322-20 |
| 2,5 mm | 110 mm | EV34322-25 |
| 2,7 mm | 100 mm | EV34322-27 |
| 3,2 mm | 145 mm | EV34322-32 |
| 3,5 mm | 110 mm | EV34322-35 |
| 4,5 mm | 145 mm | EV34322-45 |

Spiralbohrer mit Schnellkupplungs-Ansatz  
Twist Drills, quick-action  
Taladros espirales, acople rápido  
Perforatore elicoidale con attacco rapido

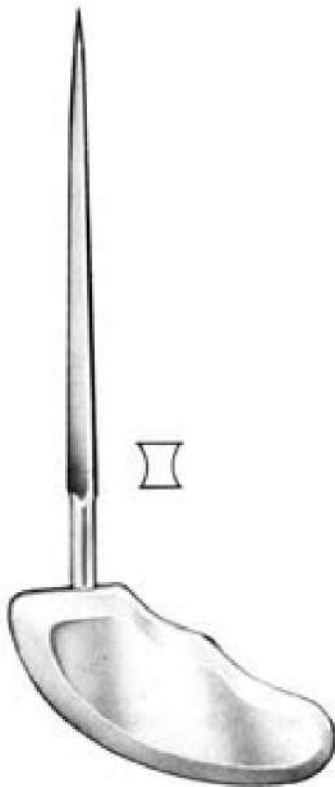
Pfrieme, Reibahle  
 Awl, Reamer  
 Escariadores  
 Lesine, Punteruoli



EV34392-14  
 14 cm, 5 1/2"



PERTHES  
 EV34393-18  
 18 cm, 7"



PERTHES  
 EV34393-21  
 21 cm, 8 1/4"

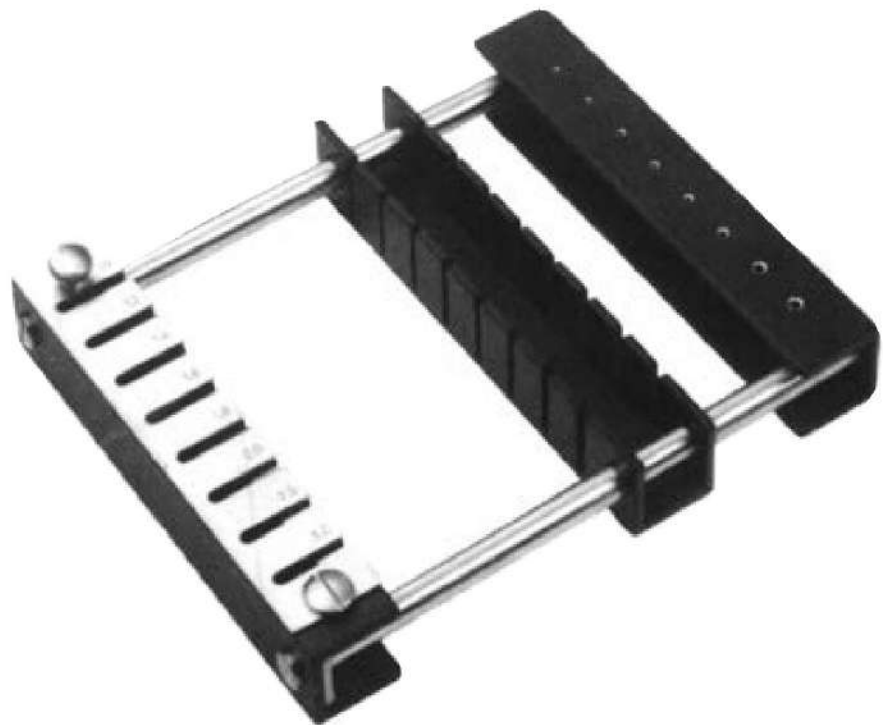


EV34394-14  
 14 cm, 5 1/2"

Faßpinzette, Bohrdrahtspender  
Grasping forceps, Support for sterilisation  
Pinzas para coger, Soporte de esterilización  
Pinze per afferrare, Supporto per la sterilizzazione



EV34439-00



Bohrdrahtspender für Kirschner-Drähte  
Support for sterilisation of Kirschner wires  
Soporte de esterilización p. alambres de Kirschner  
Supporto per la sterilizzazione dei fili di Kirschner

EV34440-01 bis 15 cm – up to 15 cm (6") – hasta 15 cm – fino a 15 cm  
EV34440-02 bis 31 cm – up to 31 cm (12 1/4") – hasta 31 cm – fino a 31 cm  
EV34440-03 bis 10 cm – up to 10 cm (4") – hasta 10 cm – fino a 10 cm

**Bohrdrähte**  
**Drill Wires**  
**Alambres**  
**Perforatori filiformi**

lieferbar in Packungen à 10 Stück  
available in packages of 10 pieces  
disponible en paquets de 10 unidades  
disponibili solo in confezioni da 10 pezzi

**Trokarspitze / Trocar point**  
**Punta trocar / Punte trequarti**



| Ø          | 10 cm, 4"  | 15 cm, 6"  | 31 cm, 12 1/4" 0,8 |
|------------|------------|------------|--------------------|
| EV34401-08 | EV34402-08 | EV34403-08 | 1,0                |
| EV34401-10 | EV34402-10 | EV34403-10 | 1,1                |
| EV34401-11 | EV34402-11 | EV34403-11 | 1,2                |
| EV34401-12 | EV34402-12 | EV34403-12 | 1,3                |
| EV34401-13 | EV34402-13 | EV34403-13 | 1,4                |
| EV34401-14 | EV34402-14 | EV34403-14 | 1,5                |
| EV34401-15 | EV34402-15 | EV34403-15 | 1,6                |
| EV34401-16 | EV34402-16 | EV34403-16 | 1,7                |
| EV34401-17 | EV34402-17 | EV34403-17 | 1,8                |
| EV34401-18 | EV34402-18 | EV34403-18 | 1,9                |
| EV34401-19 | EV34402-19 | EV34403-19 | 2,0                |
| EV34401-20 | EV34402-20 | EV34403-20 | 2,2                |
| EV34401-22 | EV34402-22 | EV34403-22 | 2,3                |
| EV34401-23 | EV34402-23 | EV34403-23 | 2,4                |
| EV34401-24 | EV34402-24 | EV34403-24 | 2,5                |
| EV34401-25 | EV34402-25 | EV34403-25 | 2,8                |
| EV34401-28 | EV34402-28 | EV34403-28 | 3,0                |
| EV34401-30 | EV34402-30 | EV34403-30 |                    |

Kirschner  
mit rundem Ende / with round shaft  
con extremo redondo / con extremo rotondo

**Trokarspitze / Trocar point**  
**Punta trocar / Punte trequarti**



| Ø          | 10 cm, 4"  | 15 cm, 6"  | 31 cm, 12 1/4" 0,8 |
|------------|------------|------------|--------------------|
| EV34404-08 | EV34405-08 | EV34406-08 | 0,9                |
| EV34404-09 | EV34405-09 | EV34406-09 | 1,0                |
| EV34404-10 | EV34405-10 | EV34406-10 | 1,1                |
| EV34404-11 | EV34405-11 | EV34406-11 | 1,2                |
| EV34404-12 | EV34405-12 | EV34406-12 | 1,3                |
| EV34404-13 | EV34405-13 | EV34406-13 | 1,4                |
| EV34404-14 | EV34405-14 | EV34406-14 | 1,5                |
| EV34404-15 | EV34405-15 | EV34406-15 | 1,6                |
| EV34404-16 | EV34405-16 | EV34406-16 | 1,7                |
| EV34404-17 | EV34405-17 | EV34406-17 | 1,8                |
| EV34404-18 | EV34405-18 | EV34406-18 | 1,9                |
| EV34404-19 | EV34405-19 | EV34406-19 | 2,0                |
| EV34404-20 | EV34405-20 | EV34406-20 | 2,2                |
| EV34404-22 | EV34405-22 | EV34406-22 | 2,3                |
| EV34404-23 | EV34405-23 | EV34406-23 | 2,4                |
| EV34404-24 | EV34405-24 | EV34406-24 | 2,5                |
| EV34404-25 | EV34405-25 | EV34406-25 | 2,8                |
| EV34404-28 | EV34405-28 | EV34406-28 | 3,0                |
| EV34404-30 | EV34405-30 | EV34406-30 |                    |

Kirschner  
mit flachem Ende / with flat shaft  
con extremo plano / con extremo piatto

**Trokarspitze / Trocar point**  
**Punta trocar / Punte trequarti**



| Ø          | 10 cm, 4"  | 15 cm, 6"  | 31 cm, 12 1/4" 0,8 |
|------------|------------|------------|--------------------|
| EV34407-08 | EV34408-08 | EV34409-08 | 0,9                |
| EV34407-09 | EV34408-09 | EV34409-09 | 1,0                |
| EV34407-10 | EV34408-10 | EV34409-10 | 1,1                |
| EV34407-11 | EV34408-11 | EV34409-11 | 1,2                |
| EV34407-12 | EV34408-12 | EV34409-12 | 1,3                |
| EV34407-13 | EV34408-13 | EV34409-13 | 1,4                |
| EV34407-14 | EV34408-14 | EV34409-14 | 1,5                |
| EV34407-15 | EV34408-15 | EV34409-15 | 1,6                |
| EV34407-16 | EV34408-16 | EV34409-16 | 1,7                |
| EV34407-17 | EV34408-17 | EV34409-17 | 1,8                |
| EV34407-18 | EV34408-18 | EV34409-18 | 1,9                |
| EV34407-19 | EV34408-19 | EV34409-19 | 2,0                |
| EV34407-20 | EV34408-20 | EV34409-20 | 2,2                |
| EV34407-22 | EV34408-22 | EV34409-22 | 2,3                |
| EV34407-23 | EV34408-23 | EV34409-23 | 2,4                |
| EV34407-24 | EV34408-24 | EV34409-24 | 2,5                |
| EV34407-25 | EV34408-25 | EV34409-25 | 2,8                |
| EV34407-28 | EV34408-28 | EV34409-28 | 3,0                |
| EV34407-30 | EV34408-30 | EV34409-30 |                    |

Kirschner  
Trokarende / Trocar shaft  
Punta trocar / Punte trequarti Bilaterali

**Lanzenspitze / Lance point**  
**Punta lanceolar / Punte lanceolata**



| Ø          | 31 cm, 12 1/4" |
|------------|----------------|
| EV34410-08 | 0,8            |
| EV34410-09 | 0,9            |
| EV34410-10 | 1,0            |
| EV34410-11 | 1,1            |
| EV34410-12 | 1,2            |
| EV34410-13 | 1,3            |
| EV34410-14 | 1,4            |
| EV34410-15 | 1,5            |
| EV34410-16 | 1,6            |
| EV34410-17 | 1,7            |
| EV34410-18 | 1,8            |
| EV34410-19 | 1,9            |
| EV34410-20 | 2,0            |
| EV34410-22 | 2,2            |
| EV34410-23 | 2,3            |
| EV34410-24 | 2,4            |
| EV34410-25 | 2,5            |
| EV34410-28 | 2,8            |
| EV34410-30 | 3,0            |

Kirschner  
mit flachem Ende / with flat shaft  
con extremo plano / con extremo piatto

lieferbar in Packungen à 10 Stück  
available in packages of 10 pieces  
disponible en paquets de 10 unidades  
disponibili solo in confezioni da 10 pezzi

Bohrdrähte, Knochennägel  
Drill Wires, Fracture pins  
Alambres, Clavos para huesos  
Perforatori filiformi, Chiodi per ossa

Lanzenspitze / Lance point  
Punta lanceolar / Punta lanceolata

Trokarspitze / Trocar point  
Punta trocar / Punta trequarti



| Ø   | 31 cm, 12 1/4" |
|-----|----------------|
| 0,8 | EV34411-08     |
| 0,9 | EV34411-09     |
| 1,0 | EV34411-10     |
| 1,1 | EV34411-11     |
| 1,2 | EV34411-12     |
| 1,3 | EV34411-13     |
| 1,4 | EV34411-14     |
| 1,5 | EV34411-15     |
| 1,6 | EV34411-16     |
| 1,7 | EV34411-17     |
| 1,8 | EV34411-18     |
| 1,9 | EV34411-19     |
| 2,0 | EV34411-20     |
| 2,2 | EV34411-22     |
| 2,3 | EV34411-23     |
| 2,4 | EV34411-24     |
| 2,5 | EV34411-25     |
| 2,8 | EV34411-28     |
| 3,0 | EV34411-30     |



|                | Ø          | Ø          | Ø          | Ø          | Ø          |
|----------------|------------|------------|------------|------------|------------|
|                | 3,5 mm     | 4,0 mm     | 4,5 mm     | 5,0 mm     | 6,0 mm     |
| 8 cm, 3 1/8"   | EV34412-08 | EV34413-08 | EV34415-08 | EV34417-08 | EV34419-08 |
| 10 cm, 4"      | EV34412-10 | EV34413-10 | EV34415-10 | EV34417-10 | EV34419-10 |
| 12 cm, 4 3/4"  | EV34412-12 | EV34413-12 | EV34415-12 | EV34417-12 | EV34419-12 |
| 14 cm, 5 1/2"  | EV34412-14 | EV34413-14 | EV34415-14 | EV34417-14 | EV34419-14 |
| 16 cm, 6 1/4"  | EV34412-16 | EV34413-16 | EV34415-16 | EV34417-16 | EV34419-16 |
| 18 cm, 7"      | EV34412-18 | EV34413-18 | EV34415-18 | EV34417-18 | EV34419-18 |
| 20 cm, 8"      | EV34412-20 | EV34413-20 | EV34415-20 | EV34417-20 | EV34419-20 |
| 22 cm, 8 3/4"  | EV34412-22 | EV34413-22 | EV34415-22 | EV34417-22 | EV34419-22 |
| 23 cm, 9"      | EV34412-23 | EV34413-23 | EV34415-23 | EV34417-23 | EV34419-23 |
| 24 cm, 9 1/2"  | EV34412-24 | EV34413-24 | EV34415-24 | EV34417-24 | EV34419-24 |
| 26 cm, 10 1/4" | EV34412-26 | EV34413-26 | EV34415-26 | EV34417-26 | EV34419-26 |
| 28 cm, 11"     | EV34412-28 | EV34413-28 | EV34415-28 | EV34417-28 | EV34419-28 |
| 30 cm, 11 3/4" | EV34412-30 | EV34413-30 | EV34415-30 | EV34417-30 | EV34419-30 |

Kirschner  
mit rundem Ende / with round shaft  
con extremo redondo / con extremo rotondo

Steinmann  
mit rundem Ende / with round shaft  
con extremo redondo / con extremo rotondo

Trokarspitze / Trocar point  
Punta trocar / Punta trequarti



|                | Ø          | Ø          | Ø          | Ø          | Ø          |
|----------------|------------|------------|------------|------------|------------|
|                | 3,5 mm     | 4,0 mm     | 4,5 mm     | 5,0 mm     | 6,0 mm     |
| 8 cm, 3 1/8"   | EV34420-08 | EV34421-08 | EV34423-08 | EV34425-08 | EV34427-08 |
| 10 cm, 4"      | EV34420-10 | EV34421-10 | EV34423-10 | EV34425-10 | EV34427-10 |
| 12 cm, 4 3/4"  | EV34420-12 | EV34421-12 | EV34423-12 | EV34425-12 | EV34427-12 |
| 14 cm, 5 1/2"  | EV34420-14 | EV34421-14 | EV34423-14 | EV34425-14 | EV34427-14 |
| 16 cm, 6 1/4"  | EV34420-16 | EV34421-16 | EV34423-16 | EV34425-16 | EV34427-16 |
| 18 cm, 7"      | EV34420-18 | EV34421-18 | EV34423-18 | EV34425-18 | EV34427-18 |
| 20 cm, 8"      | EV34420-20 | EV34421-20 | EV34423-20 | EV34425-20 | EV34427-20 |
| 22 cm, 8 3/4"  | EV34420-22 | EV34421-22 | EV34423-22 | EV34425-22 | EV34427-22 |
| 23 cm, 9"      | EV34420-23 | EV34421-23 | EV34423-23 | EV34425-23 | EV34427-23 |
| 24 cm, 9 1/2"  | EV34420-24 | EV34421-24 | EV34423-24 | EV34425-24 | EV34427-24 |
| 26 cm, 10 1/4" | EV34420-26 | EV34421-26 | EV34423-26 | EV34425-26 | EV34427-26 |
| 28 cm, 11"     | EV34420-28 | EV34421-28 | EV34423-28 | EV34425-28 | EV34427-28 |
| 30 cm, 11 3/4" | EV34420-30 | EV34421-30 | EV34423-30 | EV34425-30 | EV34427-30 |

Steinmann  
Trokarende / Trocar shaft  
Punta trocar / Punta trequarti Bilateralis



Knochennägel  
Fracture pins  
Clavos para huesos  
Chiodi per ossa

lieferbar in Packungen à 10 Stück  
available in packages of 10 pieces  
disponible en paquets de 10 unidades  
disponibili solo in confezioni da 10 pezzi

Trokarspitze / Trocar point  
Punta trocar / Punta trequarti



|                | Ø          | Ø          | Ø            | Ø          | Ø          |
|----------------|------------|------------|--------------|------------|------------|
|                | 3,5 mm     | 4,0 mm     | 4,5 mm       | 5,0 mm     | 6,0 mm     |
| 8 cm, 3 1/8"   | EV34428-08 | EV34429-08 | EV34431-08   | EV34433-08 | EV34435-08 |
| 10 cm, 4"      | EV34428-10 | EV34429-10 | EVEV34431-10 | EV34433-10 | EV34435-10 |
| 12 cm, 4 3/4"  | EV34428-12 | EV34429-12 | EVEV34431-12 | EV34433-12 | EV34435-12 |
| 14 cm, 5 1/2"  | EV34428-14 | EV34429-14 | EVEV34431-14 | EV34433-14 | EV34435-14 |
| 16 cm, 6 1/4"  | EV34428-16 | EV34429-16 | EVEV34431-16 | EV34433-16 | EV34435-16 |
| 18 cm, 7"      | EV34428-18 | EV34429-18 | EVEV34431-18 | EV34433-18 | EV34435-18 |
| 20 cm, 8"      | EV34428-20 | EV34429-20 | EVEV34431-20 | EV34433-20 | EV34435-20 |
| 22 cm, 8 3/4"  | EV34428-22 | EV34429-22 | EVEV34431-22 | EV34433-22 | EV34435-22 |
| 23 cm, 9"      | EV34428-23 | EV34429-23 | EVEV34431-23 | EV34433-23 | EV34435-23 |
| 24 cm, 9 1/2"  | EV34428-24 | EV34429-24 | EVEV34431-24 | EV34433-24 | EV34435-24 |
| 26 cm, 10 1/4" | EV34428-26 | EV34429-26 | EVEV34431-26 | EV34433-26 | EV34435-26 |
| 28 cm, 11"     | EV34428-28 | EV34429-28 | EVEV34431-28 | EV34433-28 | EV34435-28 |
| 30 cm, 11 3/4" | EV34428-30 | EV34429-30 | EVEV34431-30 | EV34433-30 | EV34435-30 |

Steinmann  
mit 3-kant-Ende / with triangular end  
con extremo triangular / con estremo triangolare

Trokarspitze / Trocar point  
Punta trocar / Punta trequarti

mit Gewinde  
threaded Wires  
con rosca  
con filetto



| Ø   | 15 cm, 6"  | 18 cm, 7"  | 20 cm, 8"  | 23 cm, 9"  | 25 cm, 10" | 31 cm, 12 1/4" |
|-----|------------|------------|------------|------------|------------|----------------|
| 1,6 | EV34436-16 | EV34437-16 | EV34438-16 | EV34439-16 | EV34440-16 | EV34441-16 1,8 |
|     | EV34436-18 | EV34437-18 | EV34438-18 | EV34439-18 | EV34440-18 | EV34441-18 2,0 |
|     | EV34436-20 | EV34437-20 | EV34438-20 | EV34439-20 | EV34440-20 | EV34441-20 2,5 |
|     | EV34436-25 | EV34437-25 | EV34438-25 | EV34439-25 | EV34440-25 | EV34441-25 2,8 |
|     | EV34436-28 | EV34437-28 | EV34438-28 | EV34439-28 | EV34440-28 | EV34441-28 3,0 |
|     | EV34436-30 | EV34437-30 | EV34438-30 | EV34439-30 | EV34440-30 | EV34441-30     |

mit rundem Ende / with round shaft  
con extremo redondo / con estremo rotondo

lieferbar in Packungen à 10 Stück  
 available in packages of 10 pieces  
 disponible en paquets de 10 unidades  
 disponibili solo in confezioni da 10 pezzi

Knochennägel  
 Fracture pins  
 Clavos para huesos  
 Chiodi per ossa

Trokarspitze / Trocar point  
 Punta trocar / Punta trequarti

mit Gewinde  
 threaded Wires  
 con rosca  
 con filetto



| Ø   | 15 cm, 6"  | 18 cm, 7"  | 20 cm, 8"  | 23 cm, 9"  | 25 cm, 10" | 31 cm, 12 1/4" |
|-----|------------|------------|------------|------------|------------|----------------|
| 1,6 | EV34442-16 | EV34443-16 | EV34444-16 | EV34445-16 | EV34446-16 | EV34447-16 1,8 |
|     | EV34442-18 | EV34443-18 | EV34444-18 | EV34445-18 | EV34446-18 | EV34447-18 2,0 |
|     | EV34442-20 | EV34443-20 | EV34444-20 | EV34445-20 | EV34446-20 | EV34447-20 2,5 |
|     | EV34442-25 | EV34443-25 | EV34444-25 | EV34445-25 | EV34446-25 | EV34447-25 2,8 |
|     | EV34442-28 | EV34443-28 | EV34444-28 | EV34445-28 | EV34446-28 | EV34447-28 3,0 |
|     | EV34442-30 | EV34443-30 | EV34444-30 | EV34445-30 | EV34446-30 | EV34447-30     |

Trokarende / Trocar shaft  
 Punta trocar / Punta trequarti

12 cm, 4 3/4"



17 cm, 6 3/4"



33 cm, 13"



|            |        |
|------------|--------|
| EV34450-08 | 0,8 mm |
| EV34450-10 | 1,0 mm |
| EV34450-12 | 1,2 mm |
| EV34450-14 | 1,4 mm |
| EV34450-15 | 1,5 mm |
| EV34450-16 | 1,6 mm |
| EV34450-18 | 1,8 mm |
| EV34450-20 | 2,0 mm |
| EV34450-22 | 2,2 mm |
| EV34450-25 | 2,5 mm |
| EV34450-30 | 3,0 mm |

|            |        |
|------------|--------|
| EV34460-08 | 0,8 mm |
| EV34460-10 | 1,0 mm |
| EV34460-12 | 1,2 mm |
| EV34460-14 | 1,4 mm |
| EV34460-15 | 1,5 mm |
| EV34460-16 | 1,6 mm |
| EV34460-20 | 2,0 mm |
| EV34460-22 | 2,2 mm |
| EV34460-25 | 2,5 mm |
| EV34460-30 | 3,0 mm |

|            |        |
|------------|--------|
| EV34470-08 | 0,8 mm |
| EV34470-10 | 1,0 mm |
| EV34470-12 | 1,2 mm |
| EV34470-14 | 1,4 mm |
| EV34470-15 | 1,5 mm |
| EV34470-16 | 1,6 mm |
| EV34470-20 | 2,0 mm |
| EV34470-22 | 2,2 mm |
| EV34470-25 | 2,5 mm |
| EV34470-30 | 3,0 mm |

Fingerschützer, Drahtgeflecht  
Finger Protectors, Wire gauze  
Dedales, Gasa metálica  
Proteggidita, maglia metallica per estensione



EV34480-01



EV34480-02



EV34480-03

LANGENBECK  
EV34480-01 - EV34480-03



EV34492-01  
klein / small / pequeño / stretto

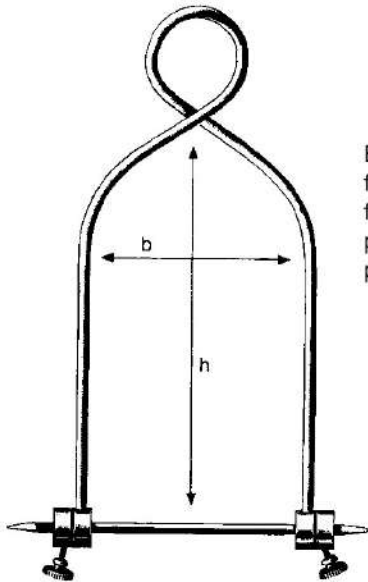
EV34492-02  
mittel / medium / mediano / medio

EV34492-03  
groß / large / grande / grande

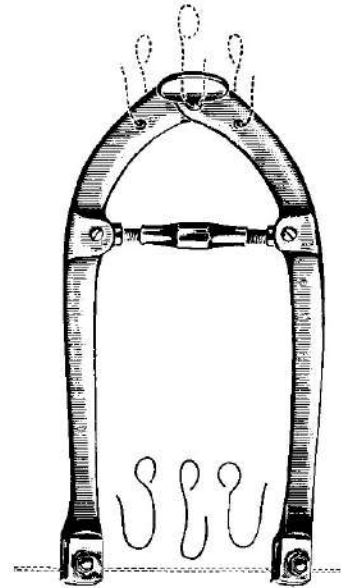
EV34492-01 - EV34492-03

sterilisierbar steril-  
izable  
esterilizabile steril-  
izzabile

Extensionsbügel  
 Extension Bows  
 Estribos para extensión  
 Archi per estensione



EV34502-16 16 x 9 cm  
 für Arm 6 1/4" x 3 1/2"  
 for arm  
 para brazo  
 per braccio

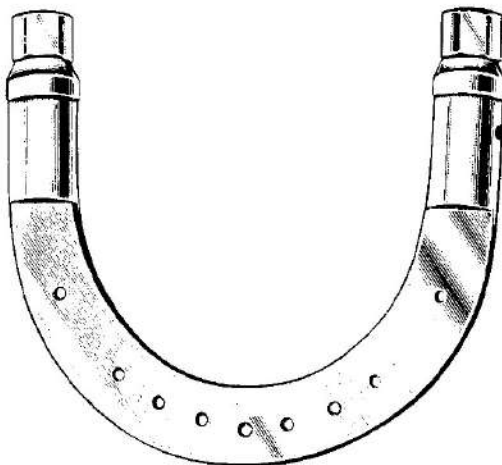


KIRSCHNER

EV34514-18 40 - 140 mm x 115 mm  
 mit 3 Zughaken  
 with 3 hooks  
 con 3 ganchos  
 con 3 ganci per trazione

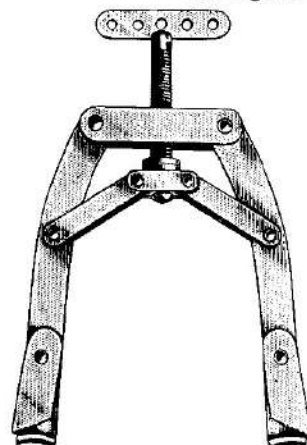
EV34514-27 60 - 220 mm x 175 mm  
 mit 3 Zughaken  
 with 3 hooks  
 con 3 ganchos  
 con 3 ganci per trazione

**BÖHLER**  
 EV34502-15 21 x 15 cm 8 1/4" x 6"  
 EV34502-21 21 x 11 cm 8 1/4" x 4 3/8"  
 für Oberschenkel und Knie  
 for thigh and knee  
 para femur y rodilla  
 per femore e ginocchio



KIRSCHNER

EV34515-09 9,5 x 7,0 cm 3 3/4" x 2 3/4"  
 EV34515-10 9,5 x 11,0 cm 3 3/4" x 4 3/8"  
 EV34515-11 10,5 x 10,0 cm 4.1" x 4"  
 EV34515-12 12,0 x 12,0 cm 4 3/4" x 4 3/4"  
 EV34515-13 13,5 x 13,0 cm 5 1/4" x 5 1/8"  
 EV34515-15 15,5 x 15,5 cm 6" x 6"  
 EV34515-20 20,0 x 15,5 cm 8" x 6"



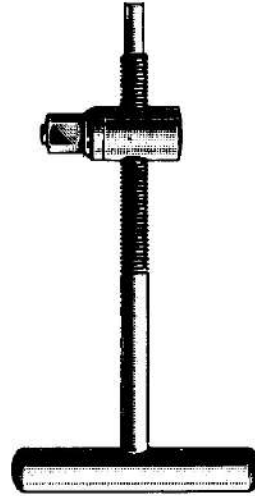
KIRSCHNER U.S.

EV34518-01  
 mittel, medium, mediano, max. 130 mm (5 1/8")  
 EV34518-02  
 groß, large, grande, grande, max. 185 mm (7 1/4")  
 EV34518-03  
 extra groß, large extra long, muy grande, max. 220 mm (8 3/4")

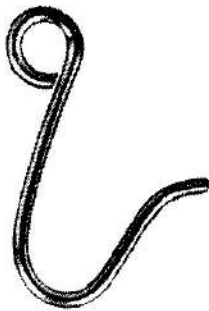
Spannschlüssel, Zughaken  
Tightening wrench, hooks  
Llave tensora, ganchos  
Chiave, ganci per trazione



EV34515-01



EV34515-02



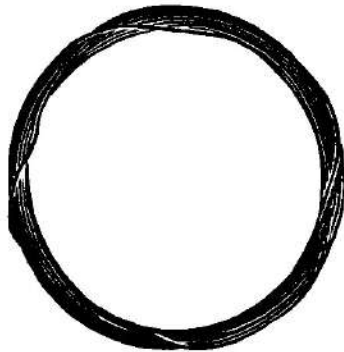
KIRSCHNER  
EV34519-01



KIRSCHNER  
EV34519-02



Knochendraht  
Bone wire  
Hilos para huesos  
Filo per ossa



weich, in Ringen zu 10 m (32,8 Feet)  
soft, in coils of 10 m (32,8 Feet)  
blando, de 10 m (32,8 Feet)  
morbido, 10 m (32,8 Feet)

Material:  
nichtrostender Implantatstahl  
nach DIN 17443 (ISO 5832/1)

mm Ø

|            |     |
|------------|-----|
| EV34520-02 | 0,2 |
| EV34520-03 | 0,3 |
| EV34520-04 | 0,4 |
| EV34520-05 | 0,5 |
| EV34520-06 | 0,6 |
| EV34520-07 | 0,7 |
| EV34520-08 | 0,8 |
| EV34520-09 | 0,9 |
| EV34520-10 | 1,0 |
| 34520-12   | 1,2 |
| 34520-15   | 1,5 |



DEMEL  
 27 cm, 10 1/2"

- Fig. 1 EV 34528-01
- Fig. 2 EV34528-02
- Fig. 3 EV34528-03

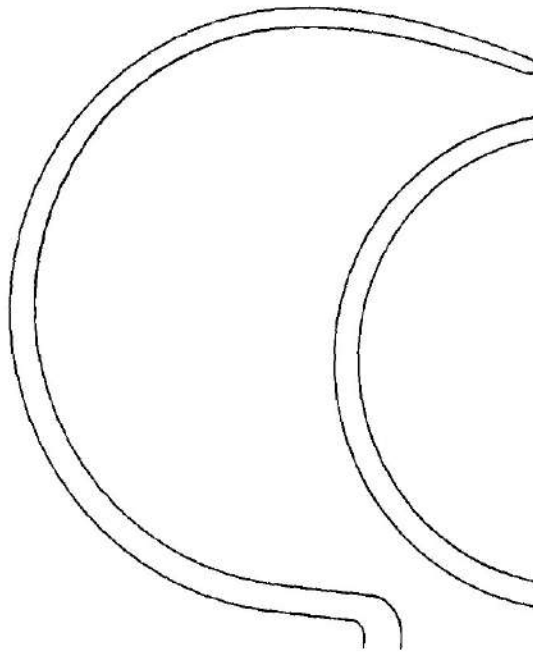


Fig. 1

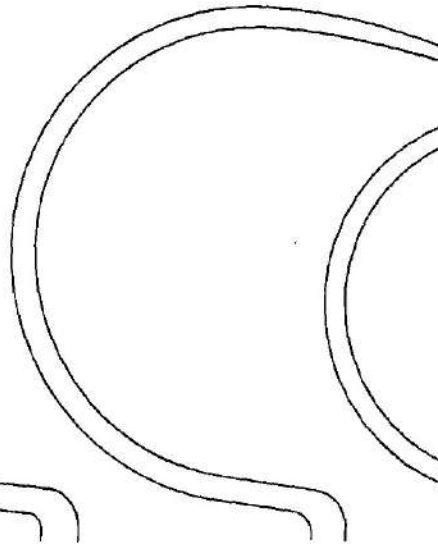


Fig. 2

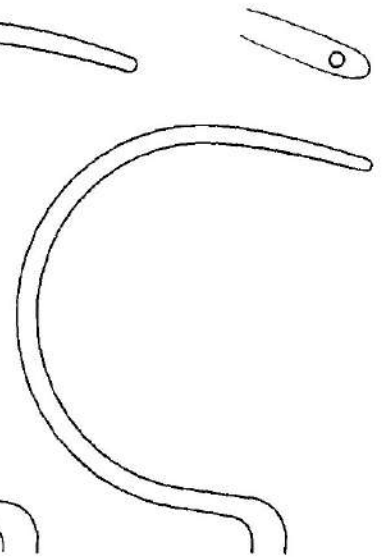
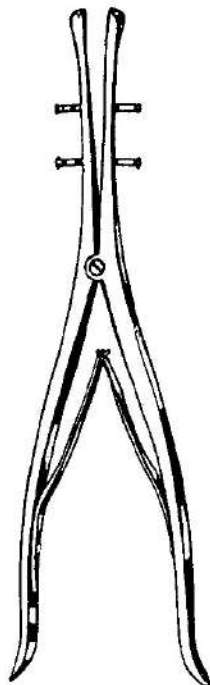
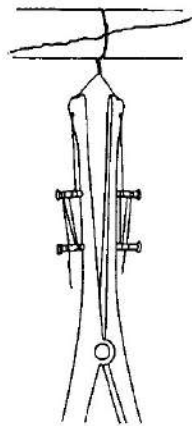


Fig. 3



DEMEL  
 EV34530-28 28 cm, 11"



LOUTE EV34531-21  
 21 cm, 8 1/4"



Flachzangen, Faßzangen  
 Flat Nose Pliers, Seizing Forceps  
 Alicates planos, Pinzas para coger alambres  
 Tenaglie piatte, Tenaglie per afferrare



17 cm, 6 3/4"  
 EV34533-17



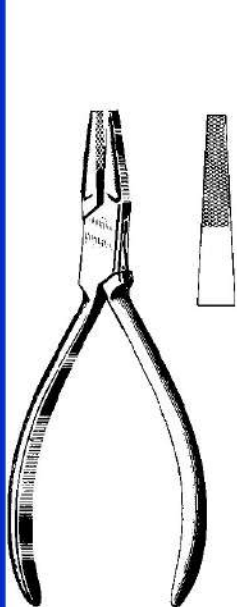
GRIP  
 18 cm, 7"  
 EV34534-18



EV34534-15  
 15 cm, 6"



EV34535-16  
 16 cm, 6 1/4"



EV34536-14  
 14 cm, 5 1/2"



EV34537-19  
 19 cm, 7 1/2"



18 cm, 7"

2 mm

4 mm

6 mm



EV34538-01 EV34538-02 EV34538-03  
 EV34539-01 TC EV34539-02 TC EV34539-03 TC

Flachzangen, Drahtkneifzangen  
 Flat Nose Pliers, Wire cutting Pliers  
 Alicates planos, Alicates para cortar alambres  
 Tenaglie piatte, Tenaglie tagliafili



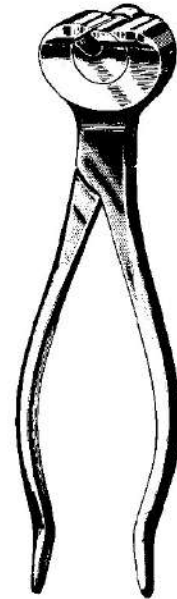
EV34540-01



EV34540-02



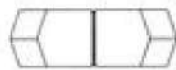
17 cm, 6 3/4"



EV34540-16  
 16 cm, 6 1/4"  
 soft wire 2,0 mm



EV34540-18  
 18 cm, 7"



EV34540-19  
 18 cm, 7"



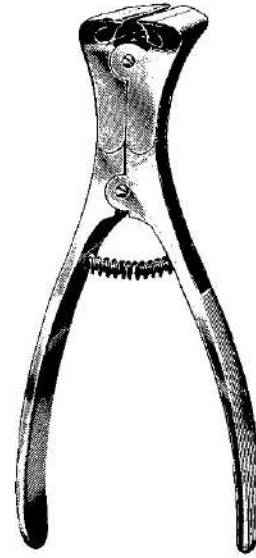
EV34540-20  
 20 cm, 8"

Drahtkneifzangen  
Wire cutting Pliers  
Alicates para cortar alambres  
Tenaglie tagliafili



EV34541-23 TC 23 cm, 9"

soft wire 3,0 mm  
hard wire 2,2 mm



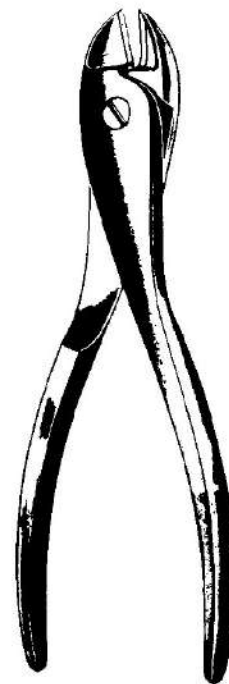
EV34542-15 TC 15 cm, 6"

Soft wire 2,0 mm  
hard wire 1,5 mm



EV34543-23 TC 23 cm, 9"

Soft wire 3,5 mm  
hard wire 2,5 mm



EV34544-18 TC 18 cm, 7"

Soft wire 2,5 mm  
hard wire 1,5 mm

**Drahtkneifzangen, Drahtfaßzangen**  
**Wire Cutting Pliers, Wire Seizing Forceps**  
**Alicates para cortar alambres, Pinzas para coger alambres**  
**Tronchese taglianti, Tenaglie per afferrare i fili**



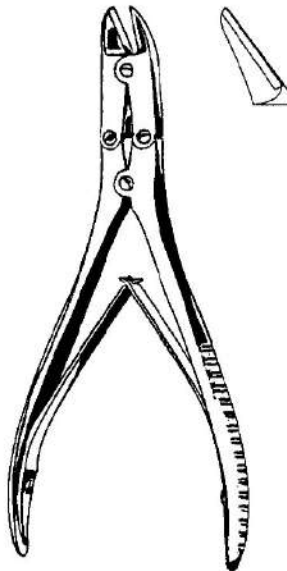
für harten Draht bis  
2,2 mm Ø  
for hard wires up to  
2,2 mm Ø  
para hilos duros  
hasta 2,2 mm Ø  
per fili duri a  
2,2 mm Ø

für weichen Draht bis  
2,5 mm Ø  
for soft wires up to  
2,5 mm Ø  
para hilos blandos  
hasta 2,5 mm Ø  
per fili dolci fino a  
2,5 mm Ø

**EV34545-22 TC 22 cm, 8 3/4"**

für harten Draht bis 1,6 mm Ø  
for hard wires up to 1,6 mm Ø  
para hilos duros hasta 1,6 mm Ø  
per fili duri a 1,6 mm Ø

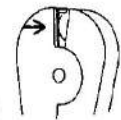
für weichen Draht bis 2,0 mm Ø  
for soft wires up to 2,0 mm Ø  
para hilos blandos hasta 2,0 mm Ø  
per fili dolci fino a 2,0 mm Ø



**EV34546-16 TC 16 cm, 6 1/4"**  
**EV34546-18 TC 18 cm, 7"**



für weichen Draht bis  
2,0 mm Ø  
for soft wires up to  
2,0 mm Ø  
para hilos blandos  
hasta 2,0 mm Ø  
per fili dolci fino a  
2,0 mm Ø



für harten Draht bis  
1,6 mm Ø  
for hard wires up to  
1,6 mm Ø  
para hilos duros  
hasta 1,6 mm Ø  
per fili duri a  
1,6 mm Ø

**EV34548-18 TC 18 cm, 7"**

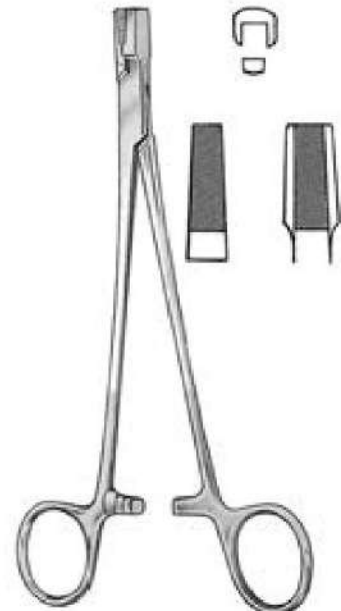


soft wire 1,5 mm  
hard wire 1,0 mm

**EV34549-14 TC 14 cm, 5 1/2"**



**EV34550-13 13 cm, 5 1/8"**  
**EV34550-18 18 cm, 7"**



**EV34551-17 TC 17 cm, 6 3/4"**

Drahtzangen  
Wire Twisting Forceps  
Pinzas para torcer hilos  
Pinza torcifili



CORWIN-HEGAR  
EV34552-16 TC 16 cm, 6 1/4"



BERRY  
EV34556-18 TC 18 cm, 7"



MAYO-HABERISSER



EV34554-15 TC 15 cm  
6"



EV34555-15 TC



EV34554-18 TC 18 cm  
7"



EV34555-18 TC



EV34554-20 TC 20 cm  
8"



EV34555-20 TC

Drahtkneifzange  
 Pin cutter  
 Alicates para cortar clavos  
 Ghigliottina per tagliare fili fino



EV34557-22 22 cm, 8 3/4"  
 EV34557-25 25 cm, 10"  
 EV34557-30 30 cm, 11 3/4"



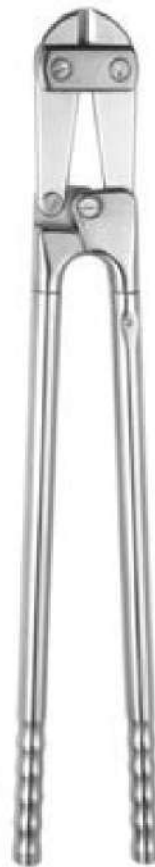
bis 2.2 mm  
 up to 2.2 mm  
 hasta 2.2 mm  
 a 2.2 mm

EV34558-32 32 cm, 12 1/2"



bis 6 mm  
 up to 6 mm  
 hasta 6 mm  
 a 6 mm

EV34559-47 TC 47 cm, 18 1/2"



bis 6.5 mm  
 up to 6.5 mm  
 hasta 6.5 mm  
 a 6.5 mm

EV34560-57 TC 57 cm, 22 1/2"



**HERCULES**

**EV34547-23 TC 23 cm / 9"**

für Bohrdrähte bis max. 3 mm Ø  
über 40% Kraftersparnis durch Spezialmechanik  
auswechselbare Hartmetallschneiden  
auswechselbare Gummibacken  
komplett sterilisierbar

for drill wires of max 3 mm Ø  
over 40% less power required by special mechanic  
exchangeable TC-blades  
exchangeable rubber jaws  
full sterilisable

para taladros filiformes de max. 3 mm Ø  
reducción de la fuerza manual en más de un 40%  
placas de tungsteno intercambiables  
bocas de goma intercambiables  
complemente esterilizable

con riduzione di forza più del 40%  
Per fili perforatori fino a 3 mm  
Placche taglienti al TC intercambiabili  
Ganasce in gomma intercambiabili  
Completamente sterilizzabili

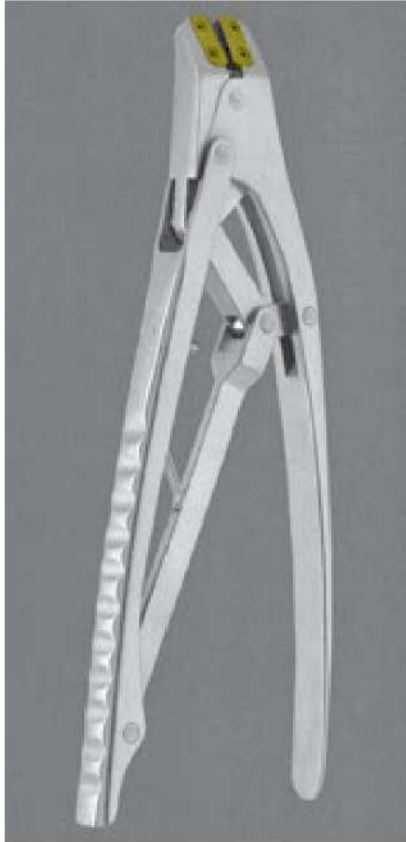
Ersatzteilsets  
Spare Part Sets  
Juegos de recambios  
Set per parti di ricambio



**EV34547-01**  
1 Paar Hartmetallschneiden / 2 Paar Schrauben / 1 Inbusschlüssel  
1 pair of TC-blades / 2 pairs of screws / 1 Allen key  
1 par de placas de tungsteno / 2 pares de tornillos / 1 llave hexagonal  
1 Paio di placche TC / 2 Paio di viti da fissaggio / 1 chiave esagonale



**EV34547-03**  
1 Paar Gummibacken / 1 Paar Schrauben  
1 pair of rubber jaws / 1 pair of screws  
1 par de bocas de goma / 1 par de tornillos  
1 Paio ganasce in gomma / 1 Paio di viti da fissaggio



### HERCULES

EV34547-28 TC 28 cm / 11"

für Bohrdrähte ab 2,5 - 4,0 mm  
über 40% Kraftersparnis durch Spezialmechanik  
auswechselbare Hartmetallschneiden  
auswechselbare Gummibacken  
komplett sterilisierbar

for drill wires of 2.5 - 4.0 mm  
over 40% less power required by special mechanic  
exchangeable TC-blades  
exchangeable rubber jaws  
full sterilisable

para taladros filiformes de 2,5 - 4,0 mm  
reducción de la fuerza manual en más de un 40%  
placas de tungsteno intercambiables  
bocas de goma intercambiables  
complemente esterilizable

con riduzione di forza più del 40%  
Per fili perforatori fino a 2,5 - 4,0 mm  
Placche taglienti al TC intercambiabili  
Ganasce in gomma intercambiabili  
Completamente sterilizzabili

Ersatzteilsets  
Spare Part Sets  
Juegos de recambios  
Set per parti di ricambio



#### EV34547-02

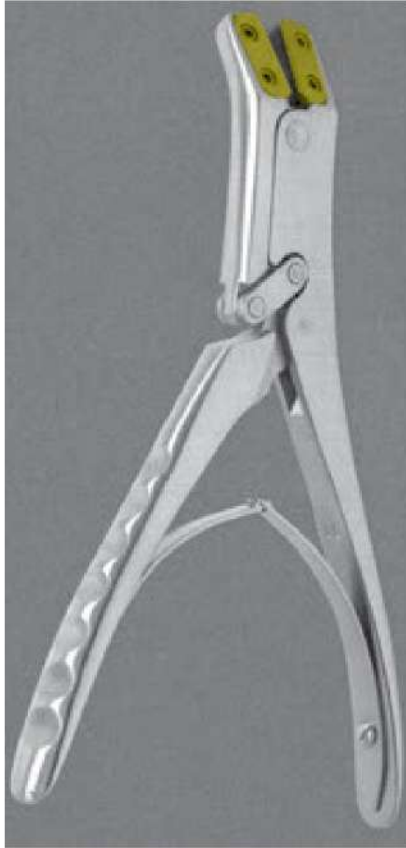
1 Paar Hartmetallschneiden / 2 Paar Schrauben / 1 Inbusschlüssel  
1 pair of TC-blades / 2 pairs of screws / 1 Allen key  
1 par de placas de tungsteno / 2 pares de tornillos / 1 llave hexagonal  
1 Paio di placche TC / 2 Paio di viti da fissaggio / 1 chiave esagonale



#### EV34547-03

1 Paar Gummibacken / 1 Paar Schrauben  
1 pair of rubber jaws / 1 pair of screws  
1 par de bocas de goma / 1 par de tornillos  
1 Paio ganasce in gomma / 1 Paio di viti da fissaggio





### HERCULES

EV35548-18 TC 18 cm / 7"

für Bohrdrähte bis max. Ø 2,2 mm  
über 40% Kraftersparnis durch Spezialmechanik, auswechselbare  
Hartmetallschneiden  
auswechselbare Gummibacken  
komplett sterilisierbar

for drill wires of max Ø 2.2 mm  
over 40% less power required by special mechanic  
exchangeable TC-blades  
exchangeable rubber jaws  
full sterilisable

para taladros filiformes de max. Ø 2,2 mm  
reducción de la fuerza manual en más de un 40%  
placas de tungsteno intercambiables  
bocas de goma intercambiables  
complemente esterilizable

con riduzione di forza più del 40%  
Per fili perforatori da 2,2 mm  
Utilizzabile a scelta per mano sinistra e destra  
Placche taglienti al TC intercambiabili  
Ganasce in gomma intercambiabili  
Completamente sterilizzabili

für Rechtshänder / for right-handers /  
para la mano derecha / per mano destra



Ersatzteilsets  
Spare Part Sets  
Juegos de recambios  
Set per parti di ricambio

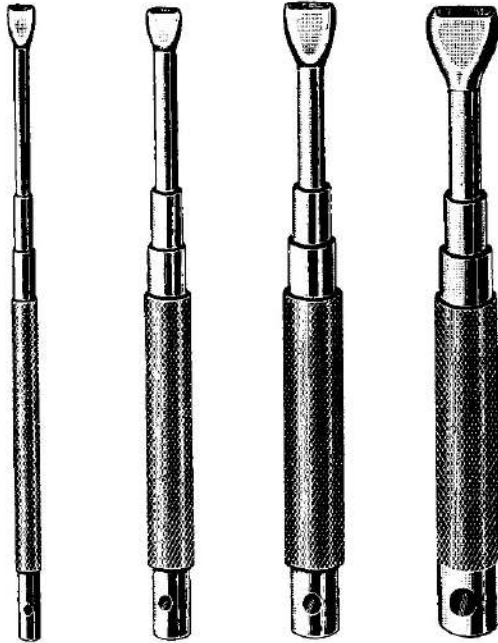


EV35547-01  
1 Paar Hartmetallschneiden / 2 Paar Schrauben / 1 Inbusschlüssel  
1 pair of TC-blades / 2 pairs of screws / 1 Allen key  
1 par de placas de tungsteno / 2 pares de tornillos / 1 llave hexagonal  
1 Paio di placche TC / 2 Paio di viti da fissaggio / 1 chiave esagonale

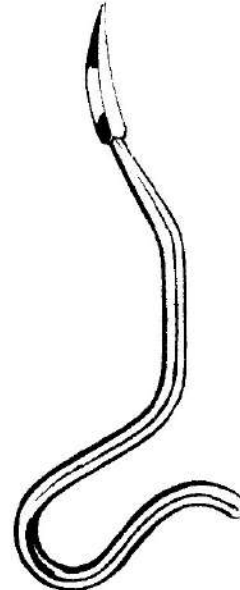


EV34547-03  
1 Paar Gummibacken / 1 Paar Schrauben  
1 pair of rubber jaws / 1 pair of screws  
1 par de bocas de goma / 1 par de tornillos  
1 Palo ganasce in gomma / 1 Paio di viti da fissaggio

Instrumentarium für Ender und Küntscher Nägel  
 Instruments for ender and Küntscher Nails  
 Instrumental para Clavos Ender y Küntscher  
 Strumentario per chiodi di Ender e Küntscher



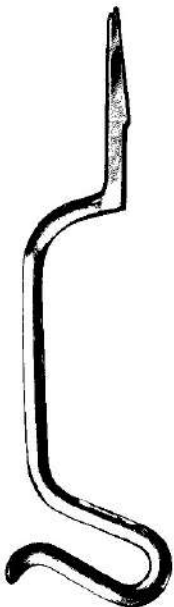
|                |            |            |            |
|----------------|------------|------------|------------|
| EV34562-24     | EV34562-32 | EV34562-48 | EV34562-64 |
| f./p. Ø 2,4 mm | 3,2 mm     | 4,8 mm     | 6,4 mm     |



|            |                |
|------------|----------------|
| KÜNTSCHER  | 26 cm, 10 1/4" |
| EV34570-01 | 8 mm           |
| EV34570-02 | 10 mm          |

Ein- und Ausschlaginstrumente für Ender-Nägel  
 Driver-extractors for Ender nails  
 Impactores-Extractores para clavos de Ender  
 Impattatore-Estrattore per chiodi di Ender

Vorböhrer zum Öffnen der Markhöhle  
 Reamers for medullary cave  
 Perforadores para la cavidad medular  
 Alesatore per l'apertura del midollo

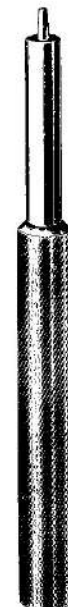


KÜNTSCHER  
 EV34573-35 35 cm, 13 3/4"  
 Aufreiber für Oberschenkel  
 Reamer for femur Perforador  
 para fémur Alesatore per  
 femore



|      |                    |
|------|--------------------|
| mm Ø | L = 60 cm, 23 3/4" |
| 3,5  | EV34583-60         |
| 4,0  | EV34584-60         |
| 5,0  | EV34585-60         |

Führungsspieße  
 Guide pins  
 Guía-conductora para clavos medulares  
 Guida conduttrice

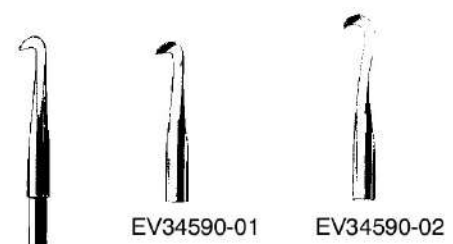


für Nägel for  
 nails para  
 clavos per  
 chiodi

|            |            |
|------------|------------|
| Ø 6-8 mm   | EV34588-01 |
| Ø 9-12 mm  | EV34588-02 |
| Ø 12-17 mm | EV34588-03 |

KUENTSCHER 19 cm, 7 1/2"

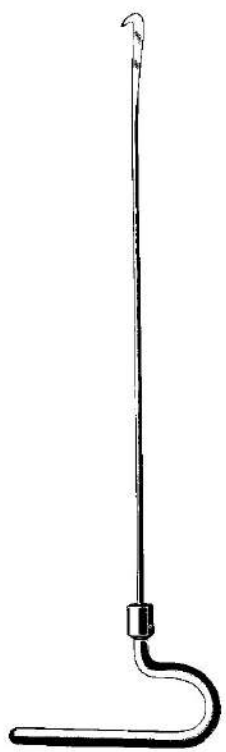
Fertigschläger  
 Nail impactors  
 Impactor final  
 Impattatore finale



KÜNTSCHER  
 EV34590-00 63 cm, 24  
 3/4" komplett mit 2 Haken EV34590-01/02  
 complete with 2 hooks EV34590-01/02  
 completo con 2 ganchos EV34590-01/02  
 completo con 2 ganci EV34590-01/02



Extraktor  
 Nail extractor  
 Aparato extractor  
 Estrattore



Extraktionshaken  
 Extraction hooks  
 Ganchos extractores  
 Gancio d'estrazione

EV34596-29 29 cm 11.4"  
 EV34596-37 37 cm 14.5"  
 EV34596-42 42 cm 16.5"  
 EV34596-49 49 cm 19.3"



Markraumböhrer  
 Intramedullary drills  
 Perforadores medulares  
 Perforatore intramidollare

Ø

|         |            |
|---------|------------|
| 6,0 mm  | EV34597-06 |
| 7,0 mm  | EV34597-07 |
| 8,0 mm  | EV34597-08 |
| 9,0 mm  | EV34597-09 |
| 10,0 mm | EV34597-10 |
| 11,0 mm | EV34597-11 |
| 12,0 mm | EV34597-12 |
| 13,0 mm | EV34597-13 |
| 14,0 mm | EV34597-14 |
| 15,0 mm | EV34597-15 |
| 16,0 mm | EV34597-16 |
| 17,0 mm | EV34597-17 |
| 18,0 mm | EV34597-18 |
| 19,0 mm | EV34597-19 |
| 20,0 mm | EV34597-20 |

Instrumentarium für Küntscher Nägel  
Instruments for Küntscher Nails  
Instrumental para Clavos Küntscher  
Strumentario per chiodi di Küntscher



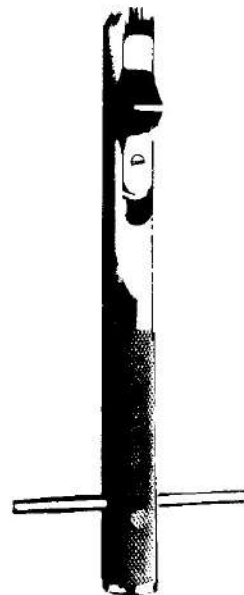
Einschläger / Nail Inserter  
Introducer clavos / Impattatore  
EV34612-00



Impactor  
EV34613-00



BENDER  
EV34615-00



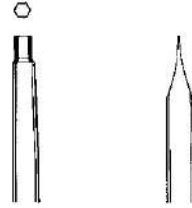
Impactor-Extractor  
Impattatore-Estrattore  
EV34617-00

6 mm



LANE  
EV34620-25 25 cm, 10"

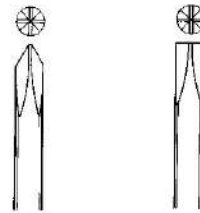
3,5 mm



EV34624-01 EV34624-02



WILLIAMS  
24 cm, 9 1/2"



EV34624-03 EV34624-04



mit Ferrozellgriff  
with Ferrozell handle  
con mango de Ferrozell  
con manico di Ferrozell



EV34628-01  
25 cm, 10"



EV34628-02  
25 cm, 10"



EV34629-01  
25 cm, 10"



1,5 mm  
EV34628-15  
20 cm, 8"



2,5 mm  
EV34628-25  
25 cm, 10"



3,5 mm  
EV34628-35  
25 cm, 10"

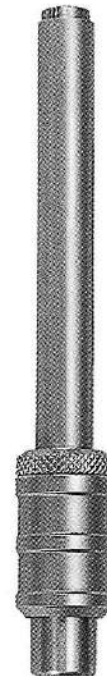
Schraubenzieher  
Screw Drivers  
Destornilladores  
Cacciaviti



LANE

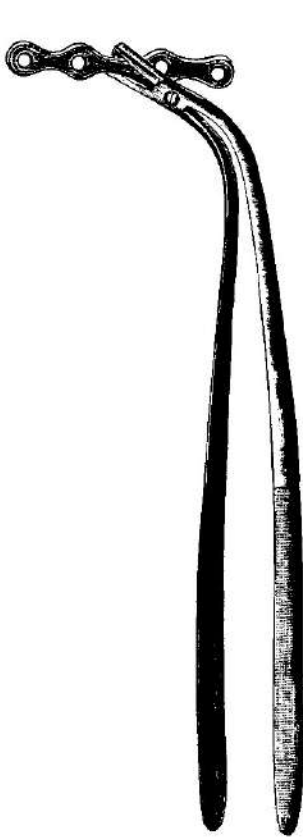
EV34632-25 25 cm, 10"

Kreuzschlitzschraubenzieher Screwdriver for  
cross slotted head Destornillador para tornillos  
con ranura en cruz  
Cacciavite a croce



Schraubenhaltehülse für Sechskantschrauben  
Screw holder

Vaina para tornillos  
Guaina per viti esagonali  
EV34634-35 3,5 mm



LANE  
EV34637-23 23 cm, 9"

Knochenplatten-Haltezange  
Plate Holding Forceps Pinza  
para sostener placas Pinza por-  
taplacche



LANE  
EV34639-22 22 cm, 8 3/4"

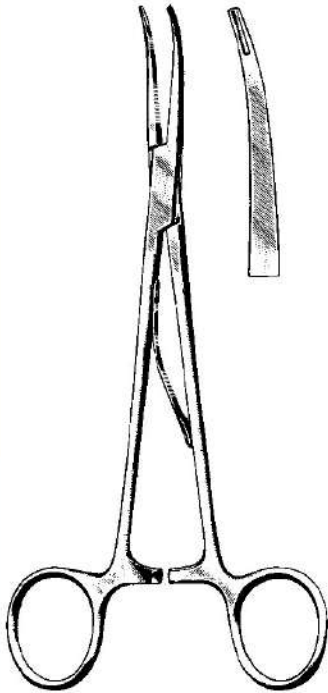
Schraubenhaltezeange Screw  
Holding Forceps Pinza para  
sostener tornillos Pinza portaviti



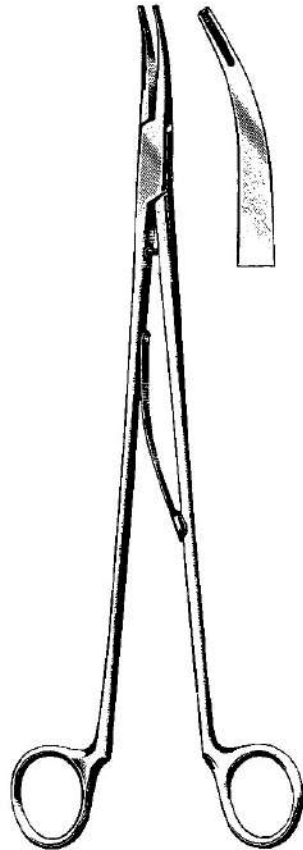
LANE  
EV34640-18 18 cm, 7"

Biegehebel f. Knochenplatten  
Plate Bender  
Palanca para doblar placas Leva  
piegaplacche

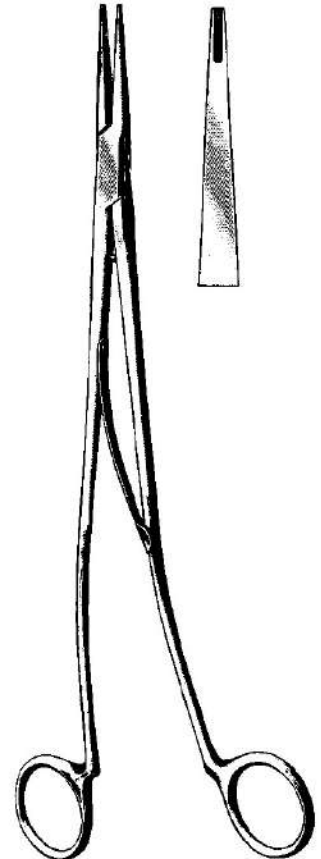
Anlegezangen, Silberklammern  
 Applying Fcps. Clips  
 Pinzas aplicadoras, Grapas  
 Pinza per applicare, Agrafes



McKENZIE  
 EV41011-15 15 cm, 6"  
 EV41011-19 19 cm, 7 1/2"



SMITHWICK  
 EV41015-23 23 cm, 9"  
 EV41015-26 26 cm, 10 1/4"

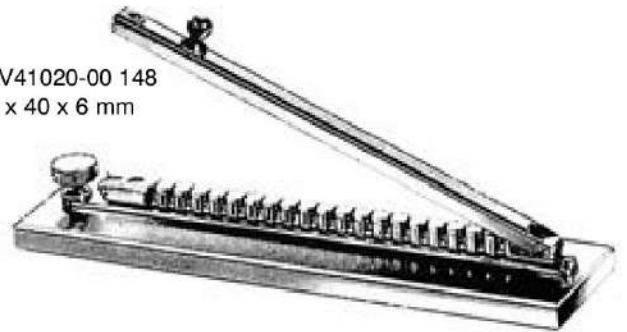


SWEET  
 EV41017-23 23 cm, 9"  
 EV41017-26 26 cm, 10 1/4"



OLIVECRONA-TOENNIS  
 EV41019-14

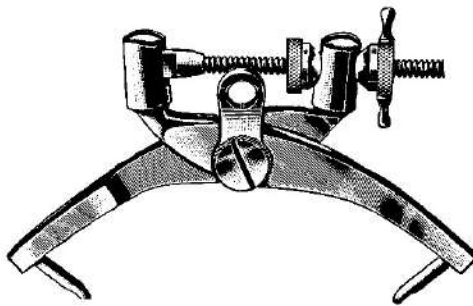
EV41020-00 148  
 x 40 x 6 mm



EV41021-00  
 (100 pcs.)







CRUTCHFIELD  
EV41025-01



CRUTCHFIELD  
EV41025-02



EV41026-35  
3,5 mm Ø



EV41026-50  
5 mm Ø

Stainless steel  
Acciaio inox



RANEY  
EV41027-00



RANEY  
EV41028-00 16 cm, 6 1/4"

Nervhaken, Durahaken  
 Nerve Hooks, Dura Hooks  
 Ganchos para nervios y para dura-madre  
 Unicini per nervi e per dura-madre



DANDY  
 EV41051-20  
 20 cm, 8"



DANDY  
 EV41052-20  
 20 cm, 8"



DANDY  
 EV41053-20  
 20 cm, 8"



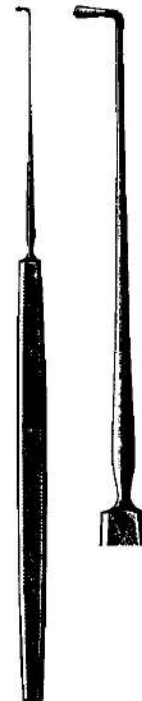
CRILE  
 EV41054-20  
 20 cm, 8"

Fig. 1



CUSHING  
 EV41056-18 18 cm, 7"  
 EV41056-28 28 cm, 11"

Fig. 2



CUSHING  
 EV41058-18 18 cm, 7"  
 EV41058-28 28 cm, 11"

Nervhaken, Durahaken  
Nerve Hooks, Dura Hooks  
Ganchos para nervios y para dura-madre  
Unicini per nervi e per dura-madre



GRAHAM  
EV41061-16  
16,5 cm, 6 1/2"



SACHS  
EV41064-16  
18,5 cm, 7 1/4"



ADSON  
EV41068-20  
20 cm, 8"

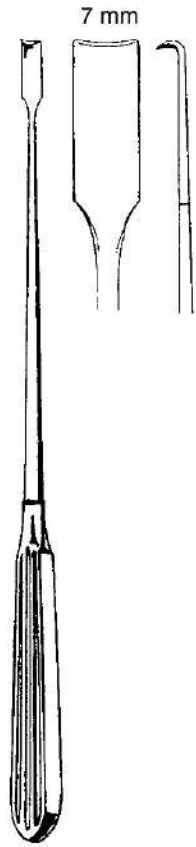


ADSON  
EV41069-20  
20 cm, 8"

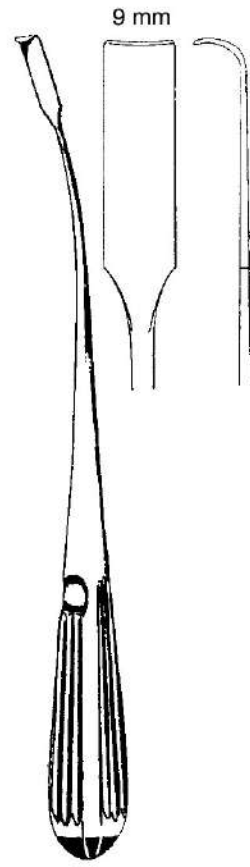


SMITHWICK  
EV41070-29  
29 cm, 11.4"

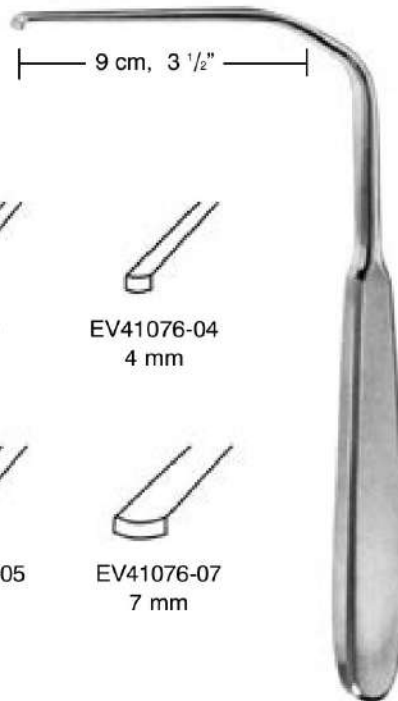
Nervwurzelnhaken  
 Nerve Root Retractors  
 Separadores de raiz de nervios  
 Uncini per le radici dei nervi



SCOVILLE  
 EV41074-23  
 23 cm, 9"



HOLSHER  
 EV41075-24  
 24 cm, 9 1/2"



HESS  
 17,5 cm, 7"



EV41076-03  
 3 mm



EV41076-04  
 4 mm



EV41076-05  
 5 mm



EV41076-07  
 7 mm

Nervwurzelnhaken  
Nerve Root Retractors  
Separadores de raiz de nervios  
Uncini per le radici dei nervi



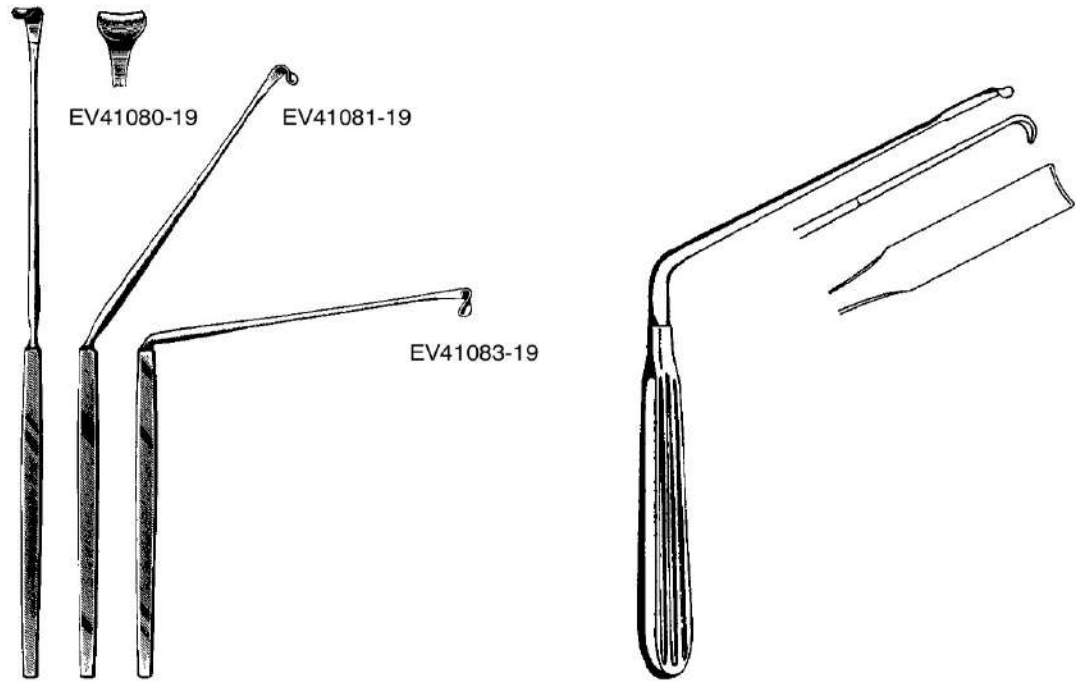
D'ERRICO  
EV41078-23  
23 cm, 9"



LOVE  
EV41079-21  
21 cm, 8 1/4"



Nervwurzelnhaken, Galeahaken  
 Nerve Root Retractors, Galea Hooks  
 Separadores de raiz de nervios, Gancho para galea  
 Uncini per le radici dei nervi, Uncini galea



LOVE  
 EV41080-19 – EV41083-19  
 19 cm, 7 1/2"

SCOVILLE  
 EV41085-20  
 20 cm, 8"



DeMARTEL  
 EV41090-33  
 33 cm, 13"



YASARGIL  
 EV41091-31  
 31 cm, 12 1/4"

Galeahaken  
 Galea Hooks  
 Gancho p/galea  
 Gancio p/galea

Ø 7 mm

4 mm



YASARGIL  
 EV41091-41  
 41 cm, 16"

Ø 9 mm

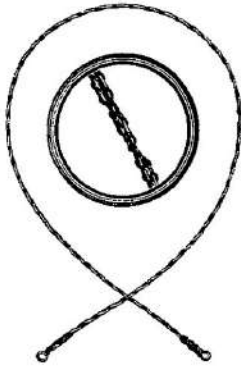
6 mm

Schädelstanze  
Cranial Punch  
Pinzas sacabocado craneal  
Pinza per craniotomia

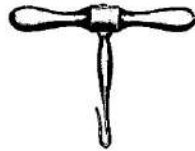


CONE  
EV41097-22  
22,5 cm 9"

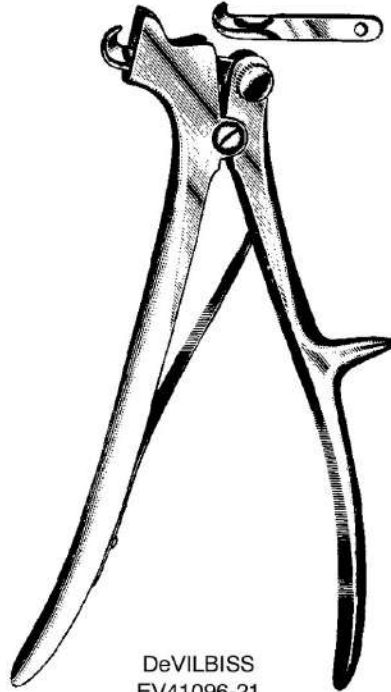
Drahtsägen, Schädelzange, Dura Dissektoren  
 Wire Saws, Skull Punches, Dura Dissectors  
 Sierras de hilo, Pinzas sacabocado craneal, Elevadores para la duramadre  
 Fili sega, Pinza per craniotomia, Scollatori per duramadre



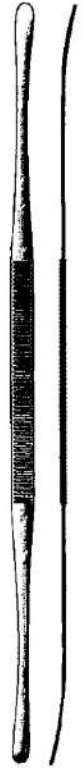
|            |     |         |
|------------|-----|---------|
| OLIVECRONA | cm  |         |
| EV41092-30 | 30, | 11 3/4" |
| EV41092-40 | 40, | 15 3/4" |
| EV41092-50 | 50, | 19 3/4" |
| EV41092-60 | 60, | 23 3/4" |
| EV41092-70 | 70, | 27 1/2" |



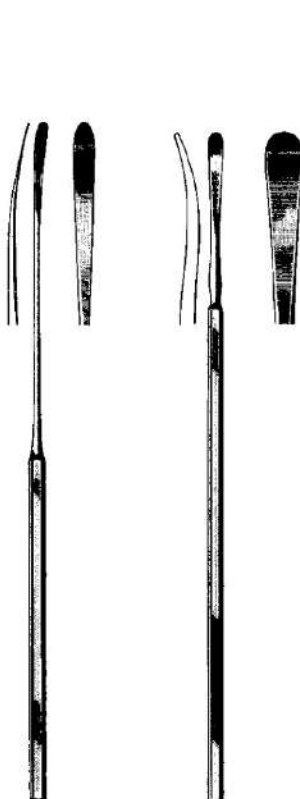
GIGLI EV41094-00  
 Drahtsägen-Handgriff  
 Wire Saw Handle  
 Mango de gancho  
 Manico con uncino



DeVILBISS  
 EV41096-21  
 21 cm, 8 1/4"



TOENNIS  
 EV41141-25  
 25 cm, 10"



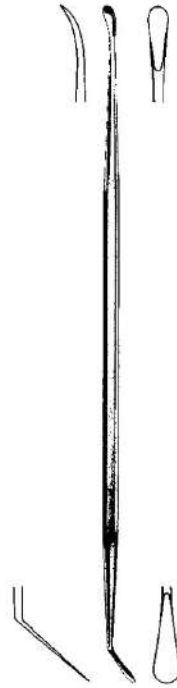
SACHS  
 EV41143-21  
 21 cm, 8 1/4"



SACHS  
 EV41145-21  
 21 cm, 8 1/4"



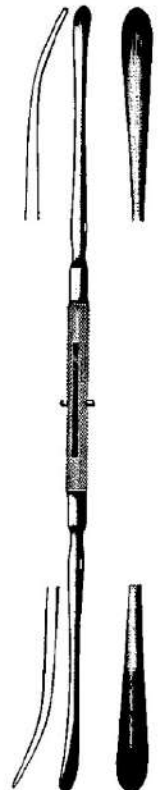
OLIVECRONA  
 EV41146-18 18 cm, 7"  
 EV41146-24 24 cm, 9 1/2"



MILLIGAN  
 EV41147-21  
 21 cm, 8 1/4"



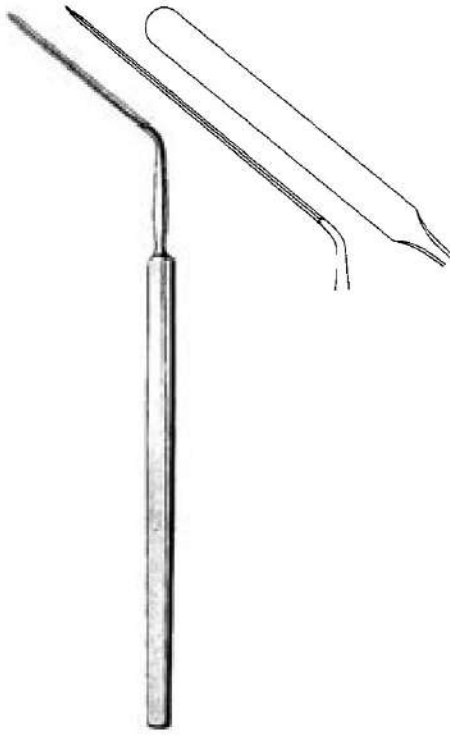
EV41149-22  
 22 cm, 8 3/4"



DAVIS  
 EV41151-24  
 24 cm, 9 1/2"



Dura Dissektoren  
Dura Dissectors  
Elevadores  
Scollatori



HORSLEY  
EV41155-20  
20 cm, 8"



WOODSON  
EV41156-18  
18 cm, 7"



FRAZIER  
EV41158-01  
15 cm, 6"



HOEN  
EV41158-02  
15 cm, 6"



HOEN  
EV41158-03  
15 cm, 6"



PENFIELD  
EV41161-01  
17,5 cm, 6.9"



PENFIELD  
EV41161-02  
19,5 cm, 7 3/4"



PENFIELD  
EV41161-03  
19,5 cm, 7 3/4"



PENFIELD  
EV41161-04  
21,5 cm, 8 1/2"



PENFIELD  
EV41161-05  
29 cm 11.4"

Hypophyse Pinzetten, Küretten  
 Hypophyseal Forceps, Curette  
 Pinzas para hipófisis, Curetas  
 Pinze per ipofisi, Curette



ADSON  
 EV41210-23  
 23 cm, 9"



ADSON  
 EV41211-23  
 23 cm, 9"



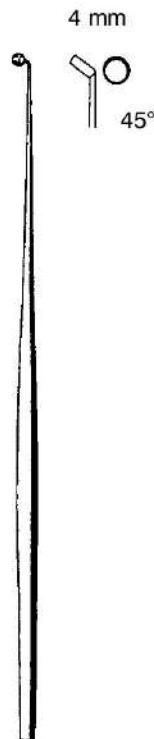
ADSON  
 EV41213-23  
 23 cm, 9"



RAY  
 EV41221-00  
 19 cm, 7 1/2"



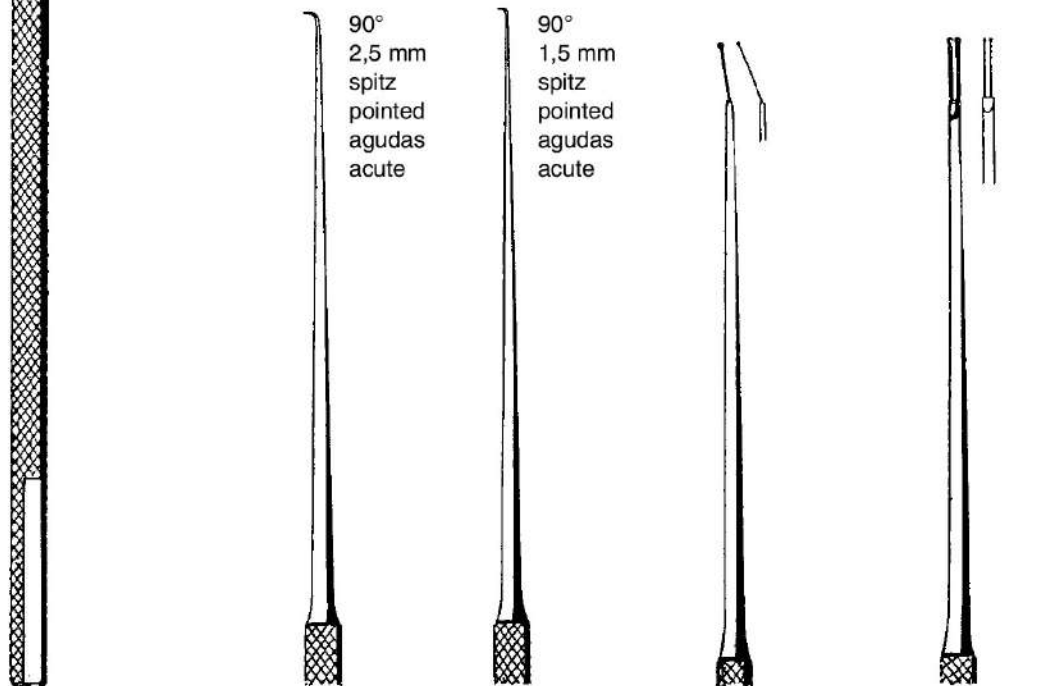
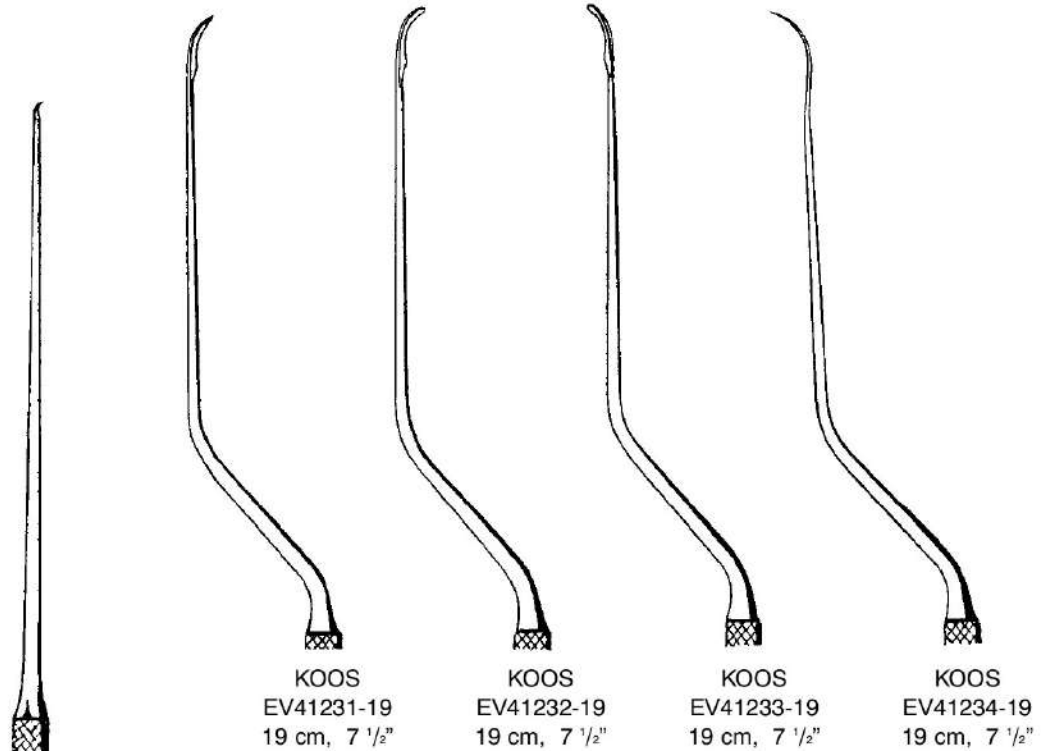
RAY  
 EV41222-00  
 19 cm, 7 1/2"



RAY  
 EV41223-00  
 19 cm, 7 1/2"



RAY  
 EV41224-00  
 19 cm, 7 1/2"



Durahaken  
 Dura Hook  
 Ganchito para dura-madre  
 Uncino dura madre

Feines Häkchen  
 Delicate Hook  
 Ganchito muy fino  
 Uncino molto fino

Knopfsonde  
 Buttoned Probe  
 Sonda abotonada  
 Sonda bottonuta

Doppelsonde  
 Twin Probe  
 Sonda doble  
 Sonda doppia

Nervhäkchen, Hirnspatel, Saugrohre  
 Nerve Hooks, Brain Spatulas, Suction Tubes  
 Ganchos para nervios, Espatulas cerebrales, Tubos de aspiración  
 Uncini per nervi, Spatole cerebrali, Tubi aspirazioni



KRAYENBÜHL  
 EV41242-19  
 19 cm, 7 1/2"



KRAYENBÜHL  
 EV41243-19  
 19 cm, 7 1/2"



KRAYENBÜHL  
 EV41244-19  
 19 cm, 7 1/2"

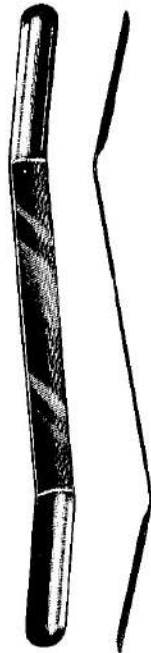


KRAYENBÜHL  
 EV41245-19  
 19 cm, 7 1/2"



CUSHING  
 18 cm, 7"  
 V41250-11 8x10 mm  
 V41250-15 13x15 mm  
 V41250-18 16x18 mm

konkav  
 concave  
 cóncavo  
 concavi



OLIVECRONA  
 18 cm, 7" mm  
 EV41253-07 7/ 9  
 EV41253-11 11/13  
 EV41253-15 15/18  
 EV41253-18 18/22



BARON  
 EV41299-03 3FR 1,0 mm  
 EV41299-05 5FR 1,6 mm  
 EV41299-07 7FR 2,3 mm

Hirnspatel, Saugrohre, Punktionskanüle  
 Brain Spatulas, Suction Tubes, Puncture Cannulas  
 Espatulas cerebrales, Tubos de aspiración, Tubo de punción  
 Spatole cerebrali, Tubi aspirazioni, cannula per punzione



biegsam  
 malleable  
 maleable  
 malleabile

|            |               |
|------------|---------------|
| DAVIS      | 18 cm, 7"     |
| EV41254-06 | 6 mm, 1/4"    |
| EV41254-10 | 9 mm, 3/8"    |
| EV41254-13 | 13 mm, 1/2"   |
| EV41254-16 | 16 mm, 5/8"   |
| EV41254-19 | 19 mm, 3/4"   |
| EV41254-25 | 25 mm, 1"     |
| EV41254-32 | 32 mm, 1 1/4" |
| EV41254-38 | 38 mm, 1 1/2" |

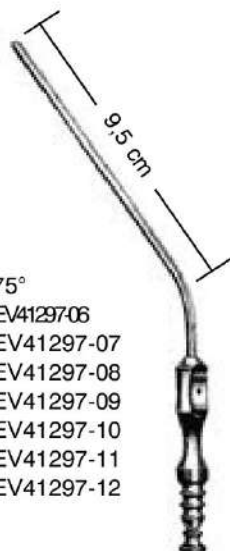


ADSON  
 EV41290-21  
 21 cm, 8 1/4"  
 ø 4 mm



isoliert  
 isolated  
 isolada  
 isolato

FERGUSSON  
 EV41294-40  
 18 cm, 7"  
 ø 4 mm, 90°



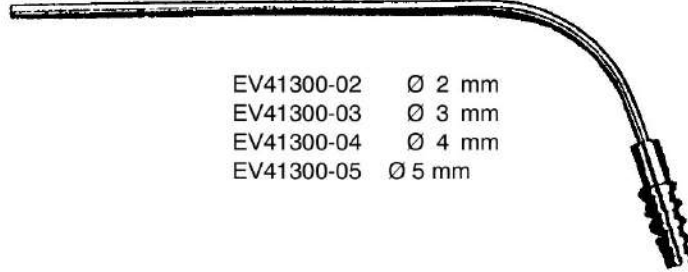
|        |            |            |
|--------|------------|------------|
| Charr. | ✂          |            |
| F.G.   | 30°        | 75°        |
| 6      | EV41295-06 | EV41297-06 |
| 7      | EV41295-07 | EV41297-07 |
| 8      | EV41295-08 | EV41297-08 |
| 9      | EV41295-09 | EV41297-09 |
| 10     | EV41295-10 | EV41297-10 |
| 11     | EV41295-11 | EV41297-11 |
| 12     | EV41295-12 | EV41297-12 |
| 15     | EV41295-15 |            |

FRAZIER/FERGUSSON  
 EV41295-06 – EV41297-12  
 19 cm, 7 1/2"



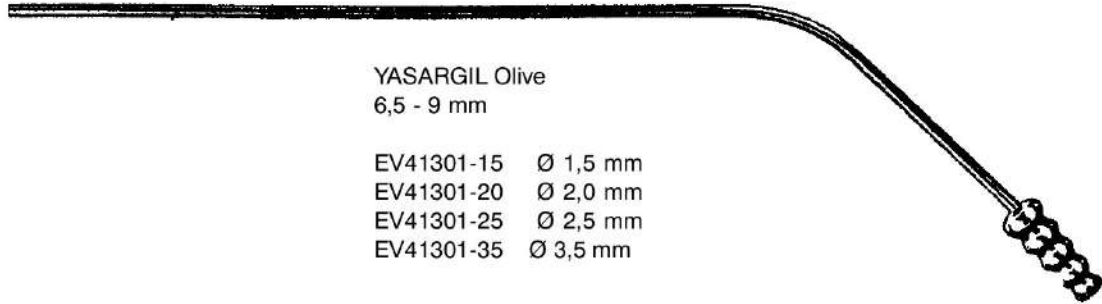
FRAZIER/FERGUSSON  
 EV41298-12  
 12 cm, 4 3/4" / 3 mm

11 cm, 4,4"



EV41300-02 Ø 2 mm  
EV41300-03 Ø 3 mm  
EV41300-04 Ø 4 mm  
EV41300-05 Ø 5 mm

15 cm, 6"



YASARGIL Olive  
6,5 - 9 mm

EV41301-15 Ø 1,5 mm  
EV41301-20 Ø 2,0 mm  
EV41301-25 Ø 2,5 mm  
EV41301-35 Ø 3,5 mm

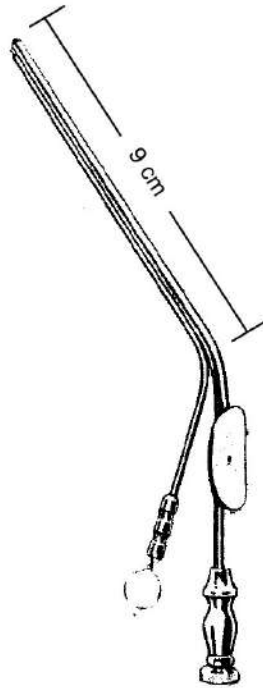


ZÖLLNER  
EV41302-02



0,5 mm Ø  
EV41306-05 0,7 mm Ø  
EV41306-07 0,9 mm Ø  
EV41306-09 1,2 mm Ø  
EV41306-12

Kanüle für Sauggriff für ZÖLLNER und WULLSTEIN  
Tip for Suction Handle for ZÖLLNER and WULLSTEIN Cánula  
para mango t ZÖLLNER y WULLSTEIN  
Cannula per manico di aspirazione t ZÖLLNER e WULLSTEIN



HOUSE

9 cm, 3 1/2"

|            |                |
|------------|----------------|
| EV41303-09 | Ø 0,9 x 0,7 mm |
| EV41303-12 | Ø 1,2 x 0,9 mm |
| EV41303-15 | Ø 1,5 x 1,2 mm |
| EV41303-18 | Ø 1,8 x 1,8 mm |
| EV41303-25 | Ø 2,5 x 2,0 mm |
| EV41303-30 | Ø 3,0 x 2,0 mm |
| EV41303-45 | Ø 4,5 x 2,0 mm |

Saugrohre, Saugkanülen  
 Suction Tubes, Suction Cannulae  
 Tubos de aspiración, Cánulas para aspiración  
 Tubi aspirazioni, Cannule per aspirazione



Sauggriff  
 Suction Handle  
 Mango de aspiración  
 Manico per aspirazione

WULLSTEIN  
 EV41307-00



Kanüle für Sauggriff  
 Tip for Suction Handle  
 Cánula para mango  
 Cannula per manico  
 di aspirazione

ROSEN  
 10 cm, 4"

|          |            |          |            |
|----------|------------|----------|------------|
| 0,5 mm Ø | EV41305-05 | 1,2 mm Ø | EV41305-12 |
| 0,6 mm Ø | EV41305-06 | 1,5 mm Ø | EV41305-15 |
| 0,7 mm Ø | EV41305-07 | 1,8 mm Ø | EV41305-18 |
| 0,8 mm Ø | EV41305-08 | 2,0 mm Ø | EV41305-20 |
| 0,9 mm Ø | EV41305-09 | 2,5 mm Ø | EV41305-25 |
| 1,0 mm Ø | EV41305-10 | 3,0 mm Ø | EV41305-30 |



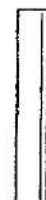
Charr. 6 EV41304-06  
 Charr. 8 EV41304-08  
 Charr. 10 EV41304-10

PLESTER  
 30°



biegsam  
 malleable  
 maleable  
 malleabile

SCHMID  
 15 cm, 6"



Ø 3 mm  
 EV41307-03



Ø 4 mm  
 EV41307-04



Ø 5 mm  
 EV41307-05



Ø 6 mm  
 EV41307-06



Wirbelkörperspreizer  
 Lamina Spreaders  
 Separadores para cuerpos vertebrales  
 Divaricatori per corpi vertebrali



CLOWARD  
 EV41401-16  
 16 cm, 6 1/4"



INGE  
 EV41405-17  
 17 cm, 6 3/4"

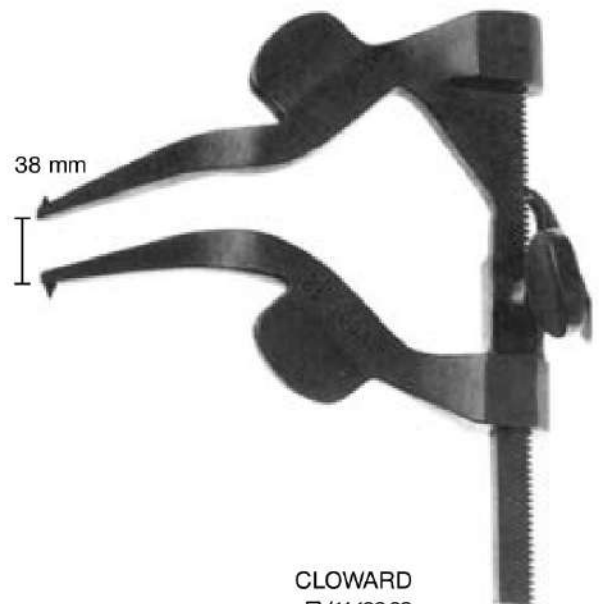


INGE  
 EV41405-27  
 27 cm, 10 1/2"



19 mm

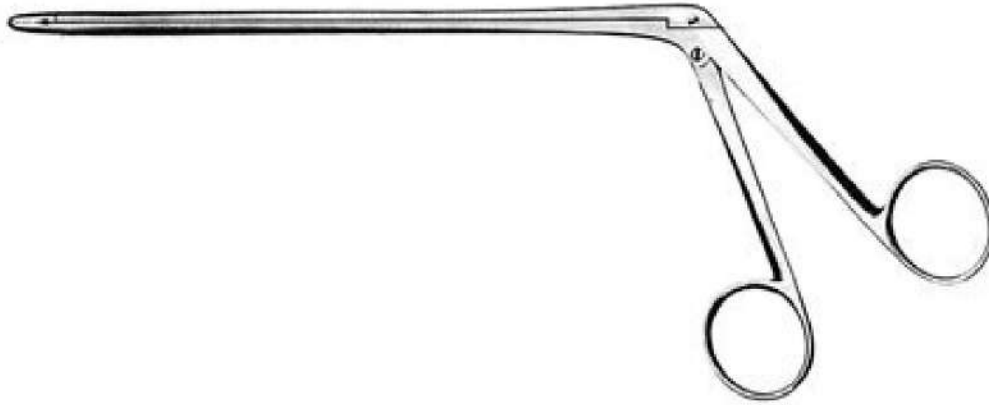
CLOWARD  
 EV41406-01  
 12,5 cm, 5"



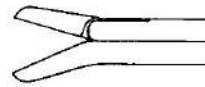
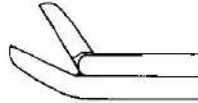
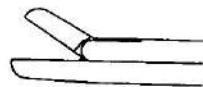
38 mm

CLOWARD  
 EV41406-02  
 7,6 cm, 3"

Laminektomie Zangen  
 Laminectomy Rongeurs  
 Pinzas cortantes para laminectomia  
 Pinze taglianti per laminectomia



CUSHING  
 2 mm

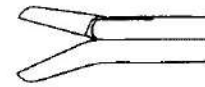
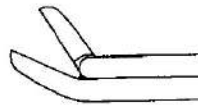
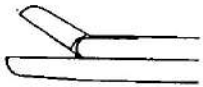


2x10 mm L  
 EV41420-01 12,5 cm  
 EV41421-01 15,0 cm  
 EV41422-01 18,0 cm

2x10 mm/45° L  
 EV41420-02 12,5 cm  
 EV41421-02 15,0 cm  
 EV41422-02 18,0 cm

2x10 mm/45° L  
 EV41420-03 12,5 cm  
 EV41421-03 15,0 cm  
 EV41422-03 18,0 cm

LOVE-GRUENWALD  
 3 mm

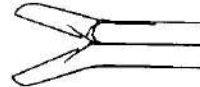
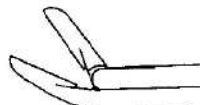
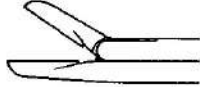


3x10 mm L  
 EV41430-01 12,5 cm  
 EV41431-01 15,0 cm  
 EV41432-01 18,0 cm

3x10 mm/45° L  
 EV41430-02 12,5 cm  
 EV41431-02 15,0 cm  
 EV41432-02 18,0 cm

3x10 mm/45° L  
 EV41430-03 12,5 cm  
 EV41431-03 15,0 cm  
 EV41432-03 18,0 cm

SPURLING  
 4 mm

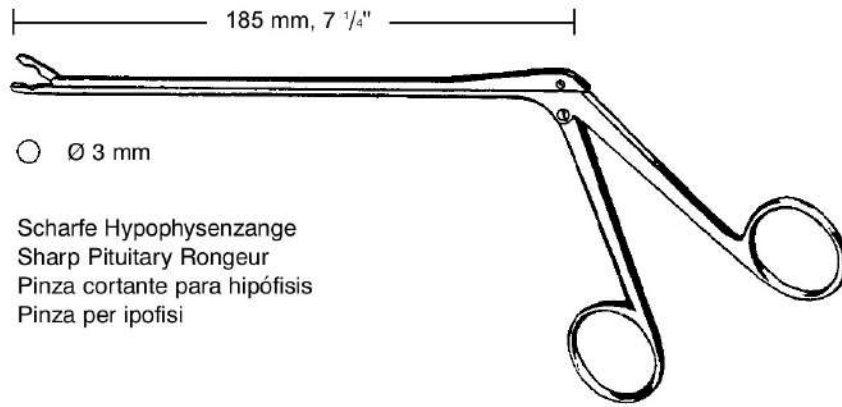


4x10 mm L  
 EV41440-01 12,5 cm  
 EV41441-01 15,0 cm  
 EV41442-01 18,0 cm

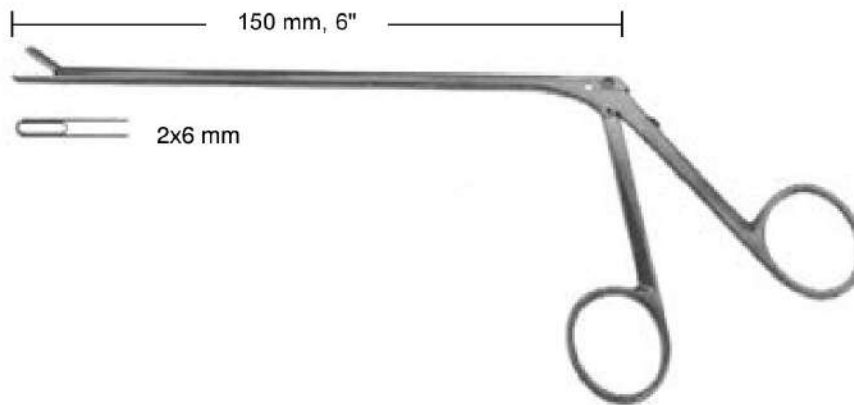
4x10 mm/45° L  
 EV41440-02 12,5 cm  
 EV41441-02 15,0 cm  
 EV41442-02 18,0 cm

4x10 mm/45° L  
 EV41440-03 12,5 cm  
 EV41441-03 15,0 cm  
 EV41442-03 18,0 cm

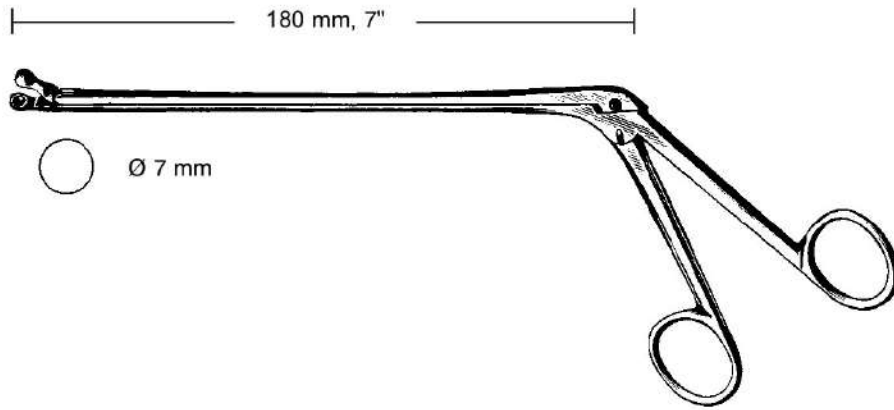
Laminektomie Zangen  
Laminectomy Rongeurs  
Pinzas cortantes para laminectomia  
Pinze taglianti per laminectomia



EV41443-26  
25,5 cm, 10"



Laminektomie Zangen  
Laminectomy Rongeurs  
Pinzas cortantes para laminectomia  
Pinze taglianti per laminectomia

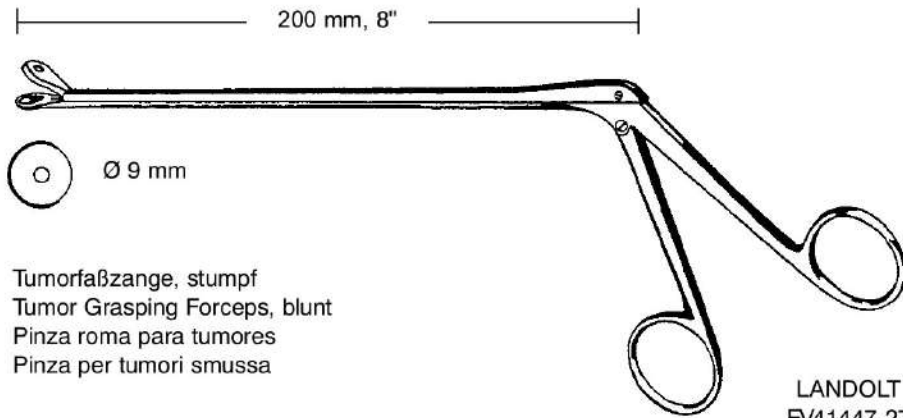


OLDBERG  
EV41445-25  
25 cm, 9.8"



PEAPOD  
EV41446-00

Laminektomie Zangen  
Laminectomy Rongeurs  
Pinzas cortantes para laminectomia  
Pinze taglianti per laminectomia



LANDOLT  
EV41447-27  
27 cm, 10 1/2"

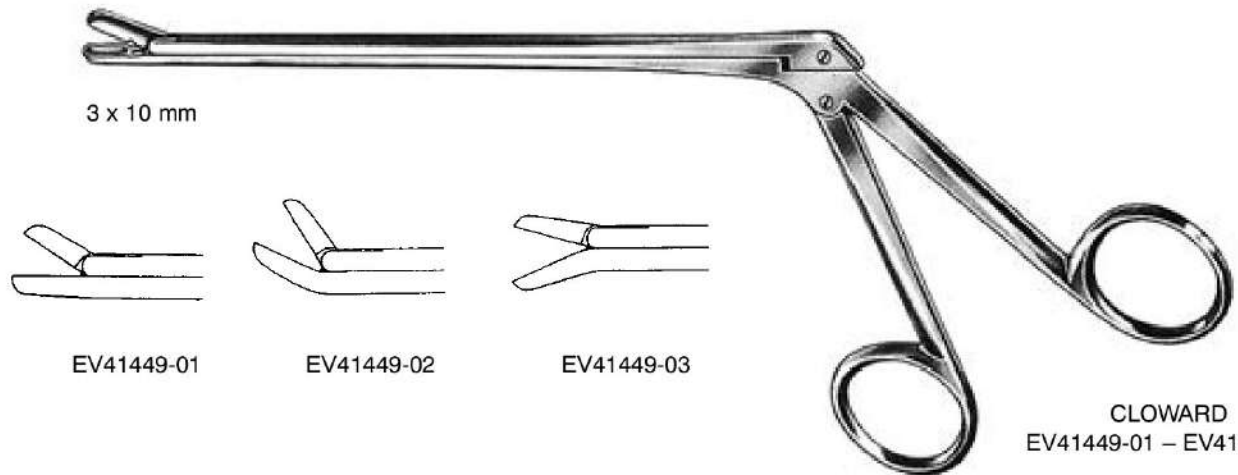
Laminektomie Zangen  
 Laminectomy Rongeurs  
 Pinzas cortantes para laminectomia  
 Pinze taglianti per laminectomia

150 mm, 6"



SCHLESINGER  
 EV41448-02 2 x 10 mm  
 EV41448-03 3 x 10 mm  
 EV41448-04 4 x 10 mm

150 mm, 6"



3 x 10 mm

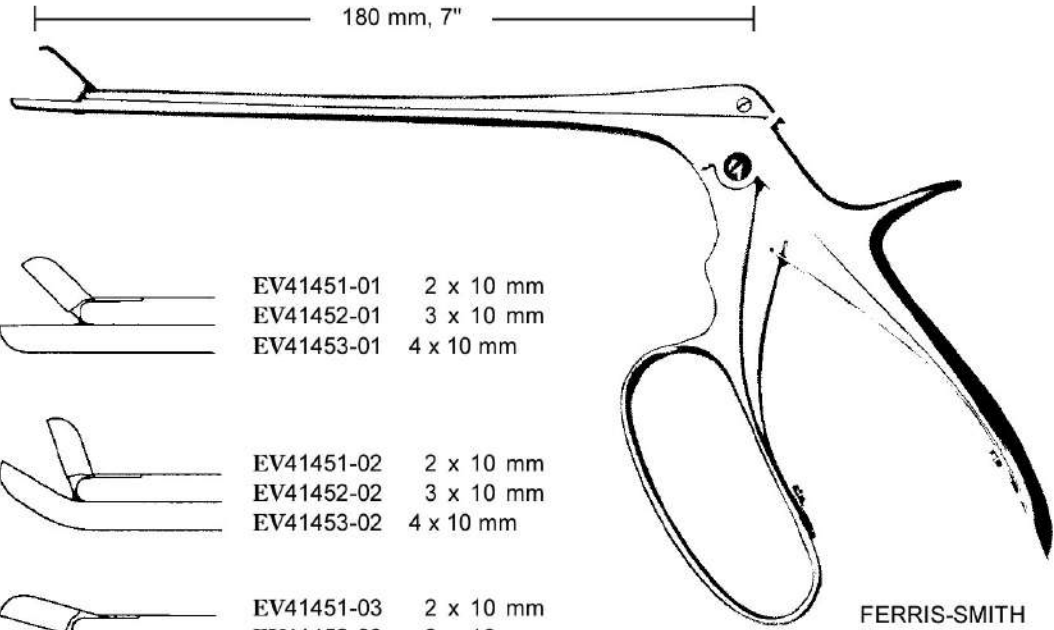
EV41449-01








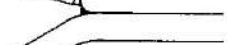

EV41449-02

EV41449-03

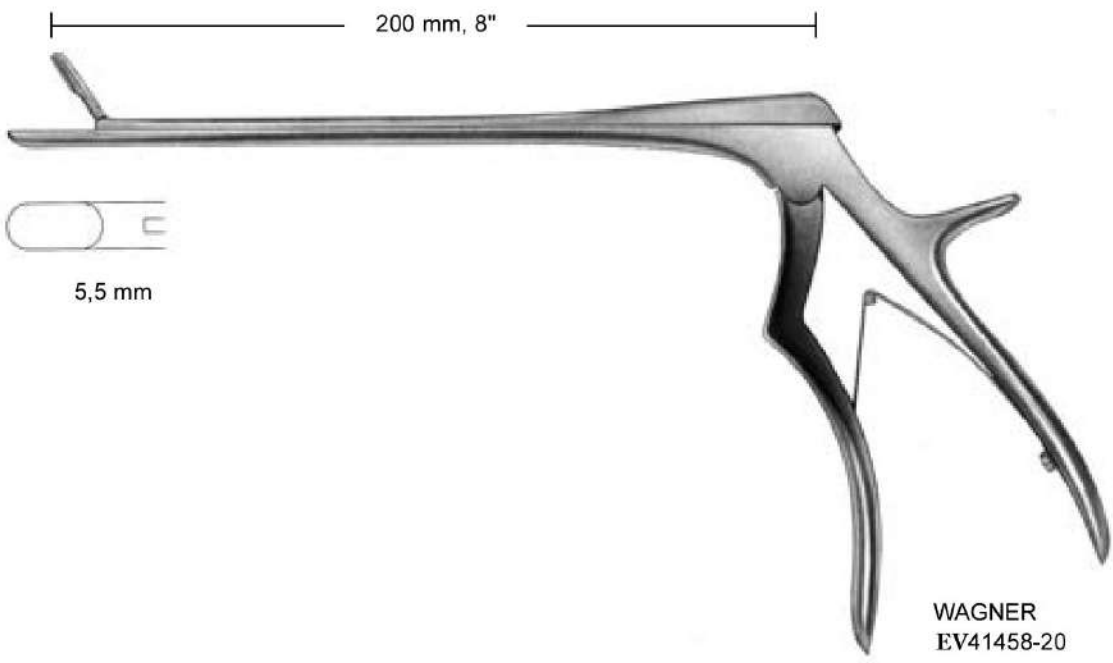
CLOWARD  
 EV41449-01 – EV41449-03

Laminektomie Zangen  
 Laminectomy Rongeurs  
 Pinzas cortantes para laminectomia  
 Pinze taglianti per laminectomia



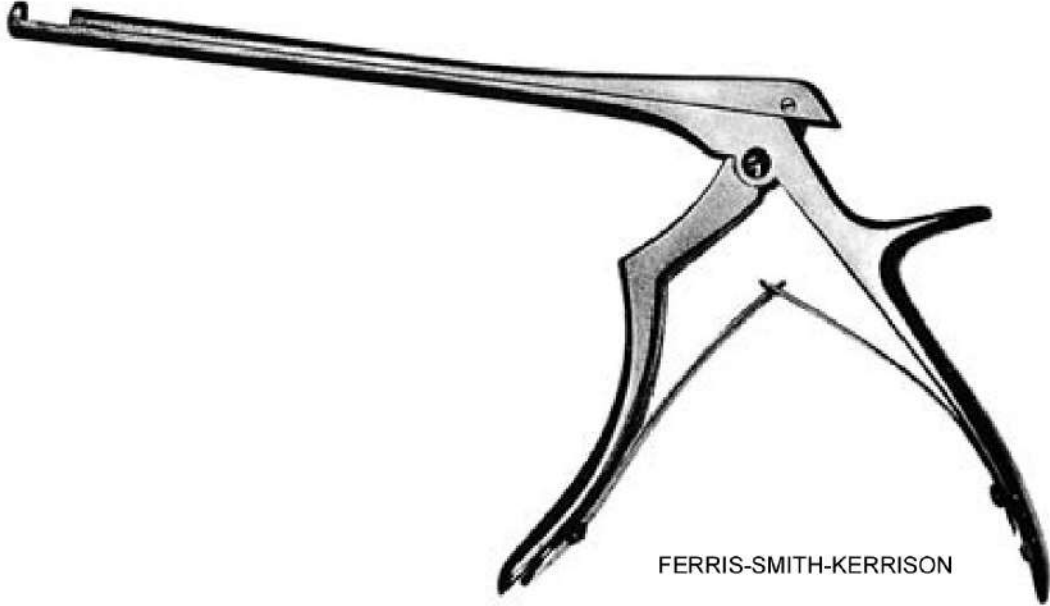
- |   |            |           |
|---|------------|-----------|
|    | EV41451-01 | 2 x 10 mm |
|    | EV41452-01 | 3 x 10 mm |
|    | EV41453-01 | 4 x 10 mm |
|    | EV41451-02 | 2 x 10 mm |
|    | EV41452-02 | 3 x 10 mm |
|   | EV41453-02 | 4 x 10 mm |
|  | EV41451-03 | 2 x 10 mm |
|  | EV41452-03 | 3 x 10 mm |
|  | EV41453-03 | 4 x 10 mm |

FERRIS-SMITH


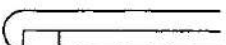





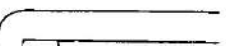

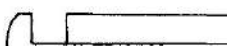


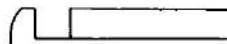
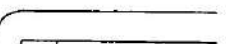
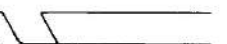


WAGNER  
 EV41458-20

Bandscheibenstanzen  
 Intervertebral Disc Rongeurs  
 Pinzas sacabocado para discos intervertebrales  
 Pinze taglianti per dischi intervertebrali



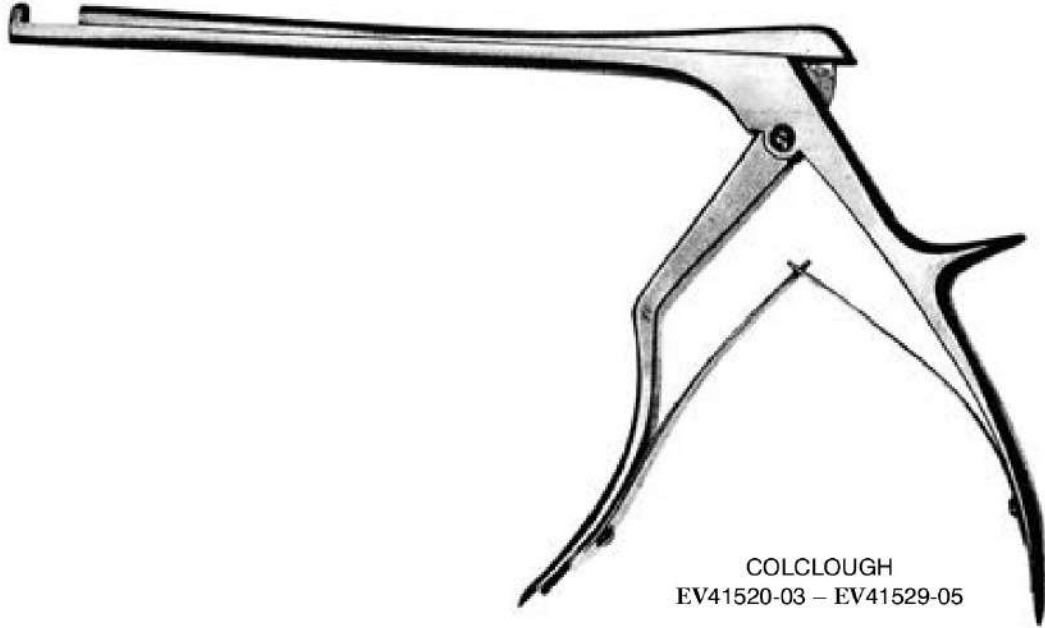
FERRIS-SMITH-KERRISON

|           | 90°   | 90°   | 40°   |
|-----------|---|---|---|
| 18 cm, 7" |  |  |  |
| 20 cm, 8" | EV41510-01 1 mm<br>EV41513-01 1 mm  | EV41511-01 1 mm<br>EV41514-01 1 mm  | EV41512-01 1 mm<br>EV41515-01 1 mm  |
| 18 cm, 7" |  |  |  |
| 20 cm, 8" | EV41510-02 2 mm<br>EV41513-02 2 mm  | EV41511-02 2 mm<br>EV41514-02 2 mm  | EV41512-02 2 mm<br>EV41515-02 2 mm  |
| 18 cm, 7" |  |  |  |
| 20 cm, 8" | EV41510-03 3 mm<br>EV41513-03 3 mm  | EV41511-03 3 mm<br>EV41514-03 3 mm  | EV41512-03 3 mm<br>EV41515-03 3 mm  |
| 18 cm, 7" |  |  |  |
| 20 cm, 8" | EV41510-04 4 mm<br>EV41513-04 4 mm  | EV41511-04 4 mm<br>EV41514-04 4 mm  | EV41512-04 4 mm<br>EV41515-04 4 mm  |
| 18 cm, 7" |  |  |  |
| 20 cm, 8" | EV41510-05 5 mm<br>EV41513-05 5 mm  | EV41511-05 5 mm<br>EV41514-05 5 mm  | EV41512-05 5 mm<br>EV41515-05 5 mm  |

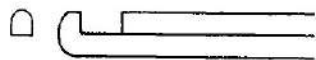
auch lieferbar mit Dünnpfuß  
 also available with thin foot plate  
 tambien disponible con lámina de punzonar estrecha  
 anche disponibile con morso sottile



Bandscheibenstanzen  
 Intervertebral Disc Rongeurs  
 Pinzas sacabocado para discos intervertebrales  
 Pinze taglianti per dischi intervertebrali

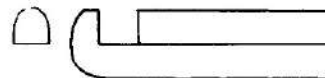


COLCLOUGH  
 EV41520-03 – EV41529-05



3 mm

EV41520-03 15 cm, 6"  
 EV41522-03 20 cm, 8"



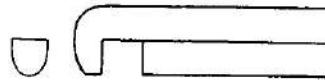
5 mm

EV41520-05 15 cm, 6"  
 EV41522-05 20 cm, 8"



3 mm

EV41524-03 15 cm, 6"  
 EV41526-03 20 cm, 8"



5 mm

EV41524-05 15 cm, 6"  
 EV41526-05 20 cm, 8"



3 mm

EV41527-03 15 cm, 6"  
 EV41529-03 20 cm, 8"



5 mm

EV41527-05 15 cm, 6"  
 EV41529-05 20 cm, 8"

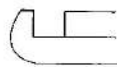


Zerlegbare Stanzen  
Detachable punches  
Pinzas cortantes desmontables  
Pinze taglienti e smontabili



FERRIS-SMITH-KERRISON  
18 cm, 7"

90°



- EV41540-02 2 mm
- EV41540-03 3 mm
- EV41540-04 4 mm
- EV41540-05 5 mm

130°



- EV41542-02 2 mm
- EV41542-03 3 mm
- EV41542-04 4 mm
- EV41542-05 5 mm



aus hochwertigem Implantat-Stahl antimagnetisch  
in high quality Implant steel antimagnetic  
de acero inoxidable para implantes de alta calidad, antimagnético  
Prodotto in acciaio di alta qualità, antimagnetico

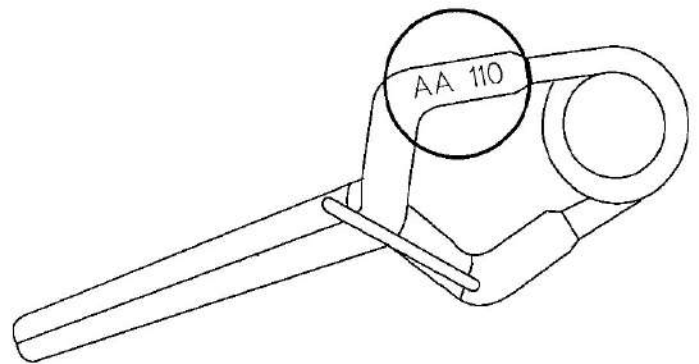
## Features of the Clip

### SERIAL-NUMBER

Each clip is coded with an individual serial number – marked by laser technology –  
The serial number guarantees a detailed follow-up of

- the whole production process
- the closure force
- from raw material to the final product

These informations are registered in our company for the period of 10 years.



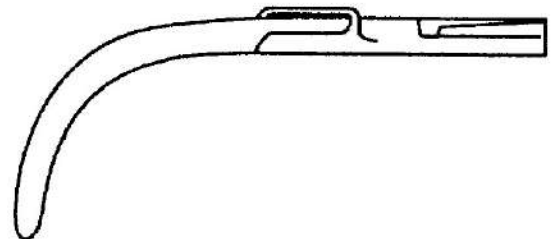
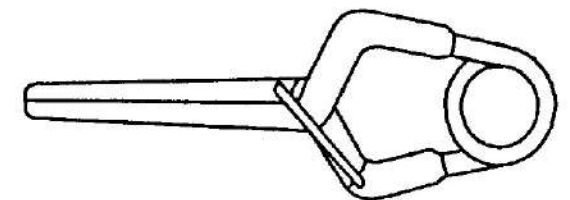
### PACKING – LABELING

Each clip is individually packaged in a transparent box made of resistant plastic.  
Special wishes of customers regarding the packaging will be considered by us. This will be marked on an internal instruction.

The transparent box is marked with a label in order to assure a quick and sure identification of the clip.

On the label you can find the following data:

- catalogue number
- Product description
- Illustration
- Closing force in g
- Tolerance range of closing force
- Blade length
- Maximum opening
- Blade geometry
- Serial number
- Jaw profile
- Material description
- Lot number
- the notes "NOT STERILE"
- WARNING



YASARGIL – Aneurysmen – Gefäß – Clips  
 YASARGIL – Aneurysm – Vessel – Clips  
 YASARGIL – Clips para aneurisma  
 YASARGIL – Clips per aneurisma

aus hochwertigem Implantat-Stahl antimagnetisch  
 in high quality Implant steel antimagnetic  
 de acero inoxidable para implantes de alta calidad, antimagnético  
 Prodotto in acciaio di alta qualità, antimagnetico

## Features of the Clip

### JAW-PROFILE

The rounded, pyramid-like structure is stamped into the jaw through a special step in production and prevents sharp edged which could perforate an aneurysm

No edges or burrs through additional rounding of structures that border the clip outer side because of this, real atraumatic application of the clip

Increased surface area due to the pyramid-like design of the jaws inner surface the cross-like structure of the inner jaws pyramid surface doubles the tissue-holding area.

The applied pressure distributes itself evenly over the length of the jaw.

The convex closure of the clip assures an atraumatic and secure closure of the aneurysm.

Sliding of the clip is prevented.

### SPRING-DESIGN

The spring size, which is different in the Standard and Mini clips, is the same within the same type of the Clip.

Through this, the highest degree of a secure fit is ensured by the clip applicator (clip/clip applicator fit)

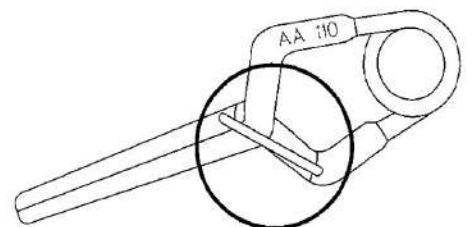
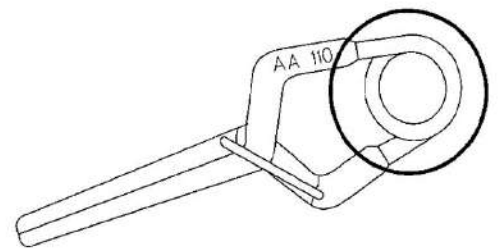
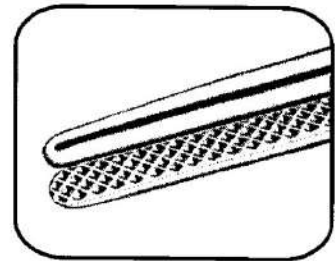
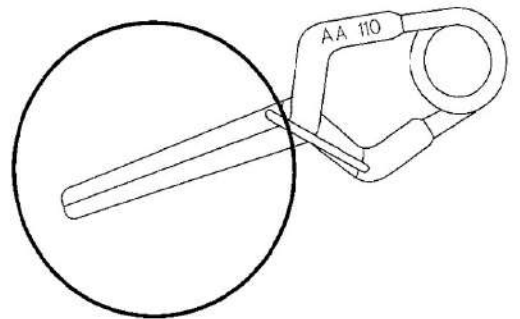
### LINK-DESIGN

Laser welded

The link ensures the precise guidance of the jaws and a "soft" opening of the clip during the whole spreading process.

The contact surface of the jaws are guided symmetrically in an exact way "over the whole length" this fact guarantees an additional stability of the clip.

No over-stress of the material because the design of the link limits the maximum opening width.



aus hochwertigem Implantat-Stahl antimagnetisch  
in high quality Implant steel antimagnetic  
de acero inoxidable para implantes de alta calidad, antimagnético  
Prodotto in acciaio di alta qualità, antimagnetico

## Features of the Clip

### CLOSING-FORCE

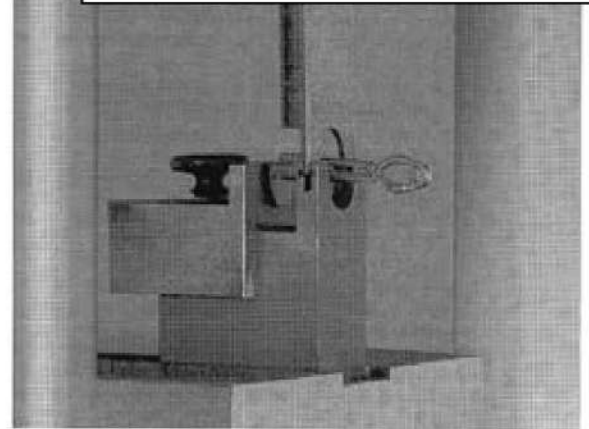
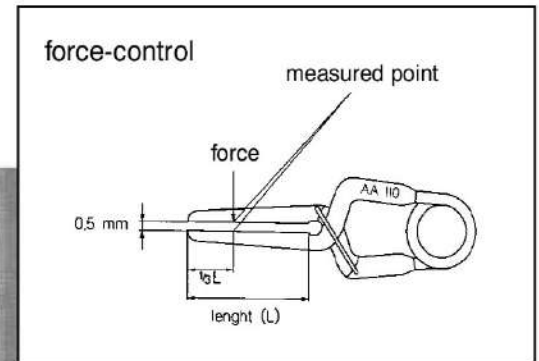
The closing force is measured at one third of the jaw length and an opening of 0,5 mm.

The final quality control of the clip is effected by a microprocessor-controlled measuring equipment.

The closing force is indicated exactly within a certain tolerance.

By the help of a special software program we assure that before the clip passes the final quality control its closure force is fixed. As a consequence we exclude any kind of manipulation.

All relevant technical data are stored during the control procedure and printed on the label.



## Material and Quality Assurance

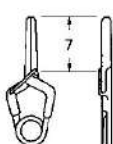
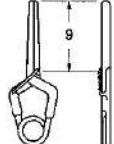
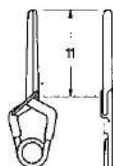
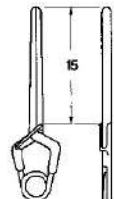
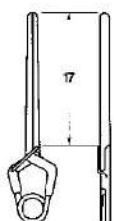
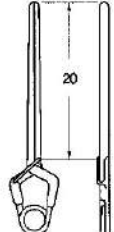
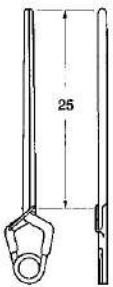
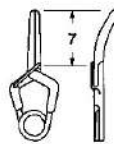
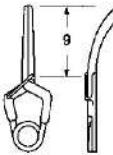
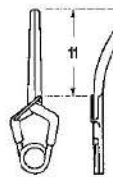
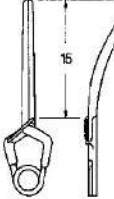
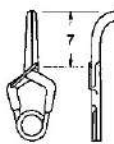
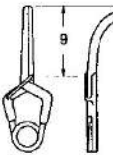
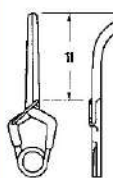
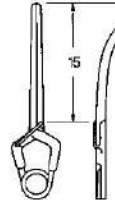


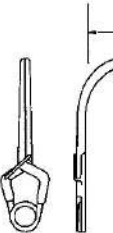
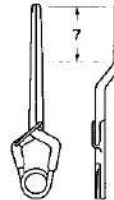
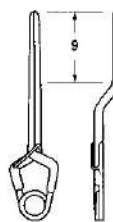
According to DIN 17445, implant steel is used in the production of our Aneurysm Clip

- High stability characteristics
- Excellent tissue compatibility
- Secure closure of blood vessels
- Antimagnetic
- Ideally suited as implantation material
- Security against over straining

aus hochwertigem Implantat-Stahl antimagnetisch  
 in high quality Implant steel antimagnetic  
 de acero inoxidable para implantes de alta calidad, antimagnético  
 Prodotto in acciaio di alta qualità, antimagnetico

YASARGIL-STANDARD für permanenten Verschluss  
 YASARGIL-STANDARD for permanent closure  
 YASARGIL-STANDARD para cierre permanente  
 YASARGIL-STANDARD con chiusura permanente

## Standard

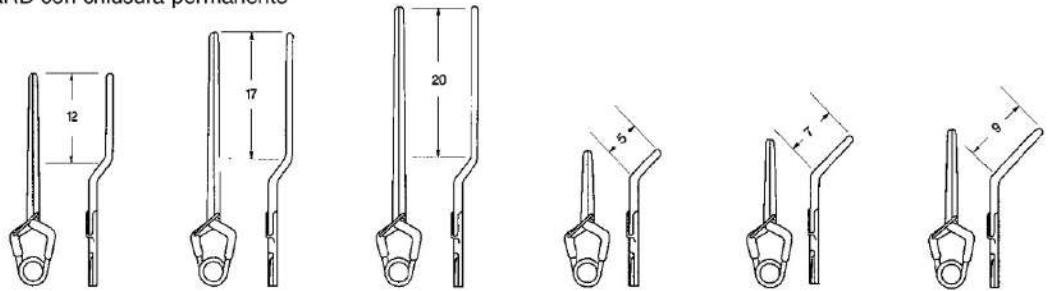
|              |   |   |   |   |  |   |   |
|--------------|---|---|---|---|--|---|---|
|              |    |    |    |   |   |    |   |
| Cat. Nr.     | EV41600-62<br>EV41600-62 T  | EV41600-70<br>EV41600-70 T  | EV41600-78<br>EV41600-78 T  | EV41600-92<br>EV41600-92 T  | EV41601-10<br>EV41601-10 T   | EV41601-11<br>EV41601-11 T  |   |
| max. opening | 6,2 mm  | 7,0 mm  | 7,8 mm  | 9,2 mm  | 10,6 mm  | 11,4 mm   |   |
| Force        | 150 gms   | 180 gms   | 180 gms   | 200 gms   | 200 gms  | 200 gms   |   |
|              |  |  |  |  |  |  |  |
|              | EV41601-13<br>EV41601-13 T  | EV41602-60<br>EV41602-60 T  | EV41602-68<br>EV41602-68 T  | EV41602-75<br>EV41602-75 T  | EV41602-87<br>EV41602-87 T   | EV41603-55<br>EV41603-55 T  | EV41603-61<br>EV41603-61 T  |
|              | 13,3 mm   | 6,0 mm  | 6,8 mm  | 7,5 mm  | 8,7 mm   | 5,5 mm  | 6,1 mm  |
|              | 200 gms   | 150 gms   | 180 gms   | 180 gms   | 200 gms  | 150 gms   | 180 gms   |
|              |   |  |  |  |   |  |  |
|              | EV41603-65<br>EV41603-65 T  | EV41603-74<br>EV41603-74 T  | EV41604-54<br>EV41604-54 T  | EV41604-58<br>EV41604-58 T  | EV41604-62<br>EV41604-62 T   | EV41604-79<br>EV41604-79 T  | EV41604-87<br>EV41604-87 T  |
|              | 6,5 mm  | 7,4 mm  | 5,4 mm  | 5,8 mm  | 6,2 mm   | 7,9 mm  | 8,7 mm  |
|              | 180 gms   | 200 gms   | 180 gms   | 180 gms   | 180 gms  | 200 gms   | 200 gms   |

YASARGIL – Aneurysmen – Gefäß – Clips  
 YASARGIL – Aneurysm – Vessel – Clips  
 YASARGIL – Clips para aneurisma  
 YASARGIL – Clips per aneurisma

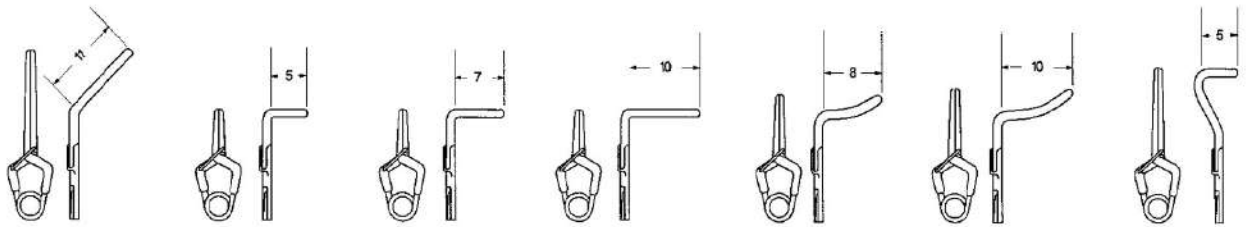
aus hochwertigem Implantat-Stahl antimagnetisch  
 in high quality Implant steel antimagnetic  
 de acero inoxidable para implantes de alta calidad, antimagnético  
 Prodotto in acciaio di alta qualità, antimagnetico

YASARGIL-STANDARD für permanenten Verschluss  
 YASARGIL-STANDARD for permanent closure  
 YASARGIL-STANDARD para cierre permanente  
 YASARGIL-STANDARD con chiusura permanente

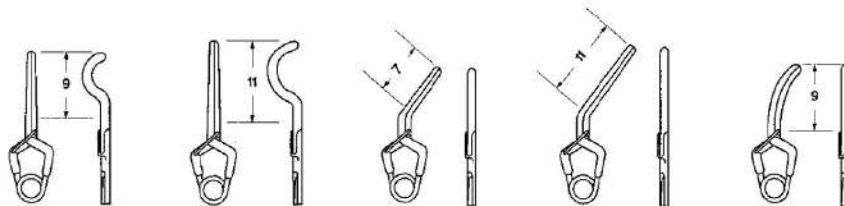
### Standard



|              |                                   |                                   |                                   |                                   |                                   |                                   |
|--------------|-----------------------------------|-----------------------------------|-----------------------------------|-----------------------------------|-----------------------------------|-----------------------------------|
| Cat. Nr.     | EV41605-10<br><b>EV41605-10 T</b> | EV41605-12<br><b>EV41605-12 T</b> | EV41605-13<br><b>EV41605-13 T</b> | EV41606-62<br><b>EV41606-62-T</b> | EV41606-65<br><b>EV41606-65 T</b> | EV41606-78<br><b>EV41606-78 T</b> |
| max. opening | 10,2 mm                           | 11,9 mm                           | 13,0 mm                           | 6,2 mm                            | 6,5 mm                            | 7,8 mm                            |
| Force        | 200 gms                           | 180 gms                           | 180 gms                           | 200 gms                           | 200 gms                           | 200 gms                           |



|                                   |                                   |                                   |                                   |                                   |                                   |                                   |
|-----------------------------------|-----------------------------------|-----------------------------------|-----------------------------------|-----------------------------------|-----------------------------------|-----------------------------------|
| EV41606-84<br><b>EV41606-84 T</b> | EV41607-56<br><b>EV41607-56 T</b> | EV41607-57<br><b>EV41607-57 T</b> | EV41607-58<br><b>EV41607-58 T</b> | EV41607-59<br><b>EV41607-59 T</b> | EV41607-60<br><b>EV41607-60 T</b> | EV41607-72<br><b>EV41607-72 T</b> |
| 8,4 mm                            | 5,6 mm                            | 5,6 mm                            | 5,6 mm                            | 5,4 mm                            | 5,6 mm                            | 7,2 mm                            |
| 200 gms                           | 200 gms                           | 200 gms                           | 200 gms                           | 200 gms                           | 200 gms                           | 200 gms                           |

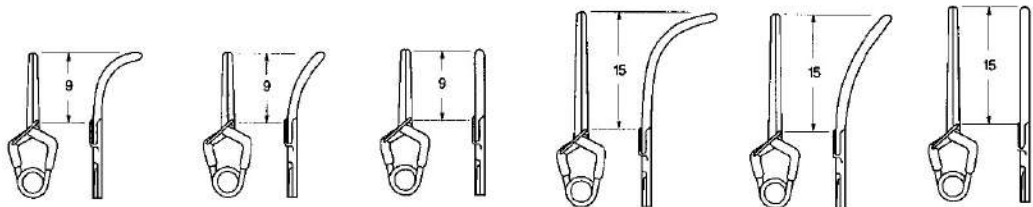


|                                   |                                   |                                   |                                   |                                   |
|-----------------------------------|-----------------------------------|-----------------------------------|-----------------------------------|-----------------------------------|
| EV41607-73<br><b>EV41607-73 T</b> | EV41607-82<br><b>EV41607-82 T</b> | EV41608-57<br><b>EV41608-57 T</b> | EV41608-80<br><b>EV41608-80 T</b> | EV41609-70<br><b>EV41609-70 T</b> |
| 7,2 mm                            | 8,2 mm                            | 5,7 mm                            | 8,0 mm                            | 7,0 mm                            |
| 200 gms                           | 200 gms                           | 200 gms                           | 200 gms                           | 200 gms                           |

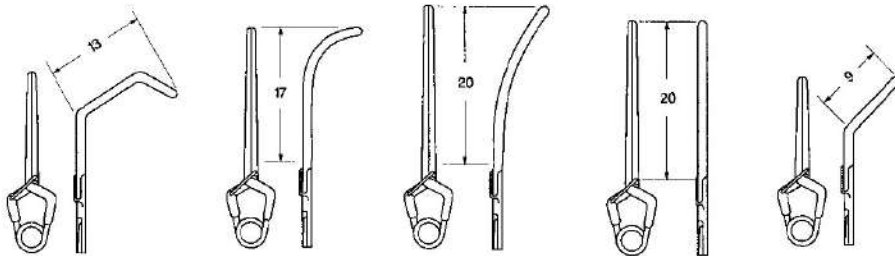
aus hochwertigem Implantat-Stahl antimagnetisch  
 in high quality Implant steel antimagnetic  
 de acero inoxidable para implantes de alta calidad, antimagnético  
 Prodotto in acciaio di alta qualità, antimagnetico

YASARGIL-STANDARD für temporären Verschluss  
 YASARGIL-STANDARD for temporary closure  
 YASARGIL-STANDARD para cierre temporal  
 YASARGIL-STANDARD con chiusura temporanea

## Standard



|              |                     |                     |                     |                     |                     |                     |
|--------------|---------------------|---------------------|---------------------|---------------------|---------------------|---------------------|
| Cat. Nr.     | EV41610-61          | EV41610-68          | EV41610-70          | EV41611-74          | EV41611-87          | EV41611-92          |
|              | <b>EV41610-61 T</b> | <b>EV41610-68 T</b> | <b>EV41610-70 T</b> | <b>EV41611-74 T</b> | <b>EV41611-87 T</b> | <b>EV41611-92 T</b> |
| max. opening | 6,1 mm              | 6,8 mm              | 7,0 mm              | 7,4 mm              | 8,7 mm              | 9,2 mm              |
| Force        | 70 gms              | 70 gms              | 70 gms              | 70 gms              | 70 gms              | 70 gms              |



|                     |                     |                     |                     |                     |
|---------------------|---------------------|---------------------|---------------------|---------------------|
| EV41612-07          | EV41612-09          | EV41612-11          | EV41612-12          | EV41612-62          |
| <b>EV41612-07 T</b> | <b>EV41612-09 T</b> | <b>EV41612-11 T</b> | <b>EV41612-12 T</b> | <b>EV41612-62 T</b> |
| 7,5 mm              | 9,9 mm              | 11,0 mm             | 11,4 mm             | 6,2 mm              |
| 90 gms              | 90 gms              | 90 gms              | 90 gms              | 70 gms              |

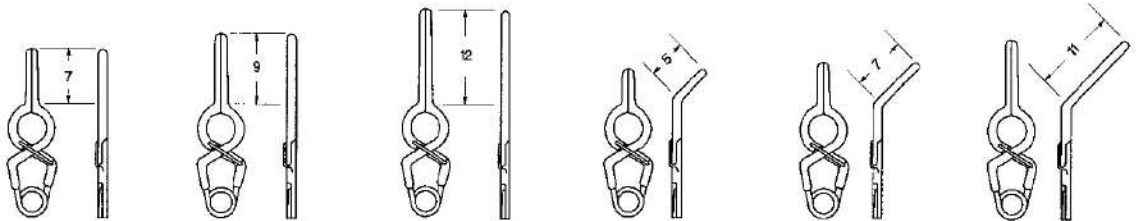


YASARGIL – Aneurysmen – Gefäß – Clips  
 YASARGIL – Aneurysm – Vessel – Clips  
 YASARGIL – Clips para aneurisma  
 YASARGIL – Clips per aneurisma

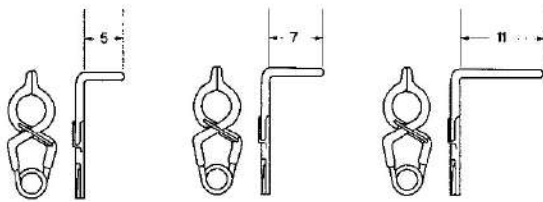
aus hochwertigem Implantat-Stahl antimagnetisch  
 in high quality Implant steel antimagnetic  
 de acero inoxidable para implantes de alta calidad, antimagnético  
 Prodotto in acciaio di alta qualità, antimagnetico

YASARGIL-STANDARD für permanenten Verschluss  
 YASARGIL-STANDARD for permanent closure  
 YASARGIL-STANDARD para cierre permanente  
 YASARGIL-STANDARD con chiusura permanente

### Standard



|              |  |  |  |  |  |  |
|--------------|--|--|--|--|--|--|
| Cat. Nr.     | <b>EV41613-74</b><br><b>EV41613-74 T</b> | <b>EV41613-84</b><br><b>EV41613-84 T</b> | <b>EV41613-96</b><br><b>EV41613-96 T</b> | <b>EV41614-58</b><br><b>EV41614-58 T</b> | <b>EV41614-65</b><br><b>EV41614-65 T</b> | <b>EV41614-72</b><br><b>EV41614-72 T</b> |
| max. opening | 7,4 mm                                   | 8,4 mm                                   | 9,6 mm                                   | 5,8 mm                                   | 6,5 mm                                   | 7,2 mm                                   |
| Force        | 150 gms                                  | 150 gms                                  | 180 gms                                  | 150 gms                                  | 150 gms                                  | 180 gms                                  |

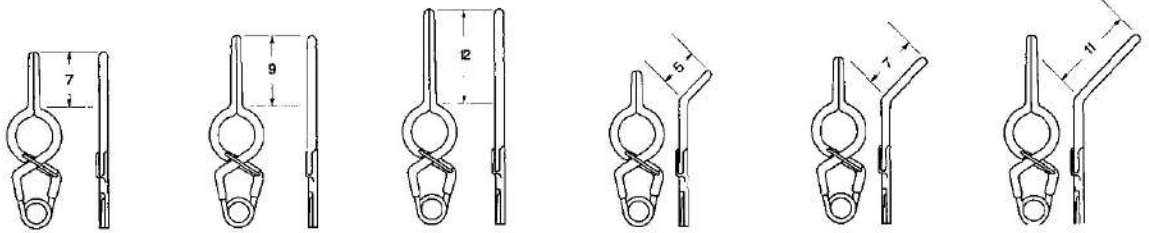


|  |  |  |
|--|--|--|
| <b>EV41615-49</b><br><b>EV41615-49 T</b> | <b>EV41615-50</b><br><b>EV41615-50 T</b> | <b>EV41615-51</b><br><b>EV41615-51 T</b> |
| 4,9 mm                                   | 4,9 mm                                   | 4,9 mm                                   |
| 150 gms                                  | 150 gms                                  | 180 gms                                  |

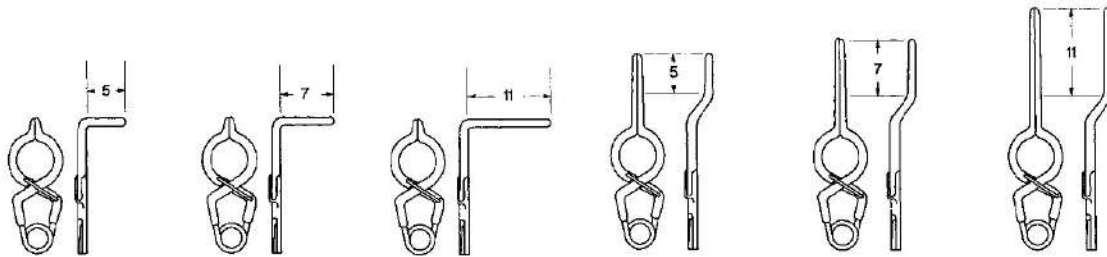
aus hochwertigem Implantat-Stahl antimagnetisch  
 in high quality Implant steel antimagnetic  
 de acero inoxidable para implantes de alta calidad, antimagnético  
 Prodotto in acciaio di alta qualità, antimagnetico

YASARGIL-STANDARD für permanenten Verschluss  
 YASARGIL-STANDARD for permanent closure  
 YASARGIL-STANDARD para cierre permanente  
 YASARGIL-STANDARD con chiusura permanente

## Standard



|              |  |  |  |  |  |  |
|--------------|--|--|--|--|--|--|
| Cat. Nr.     | <b>EV41616-79</b><br><b>EV41616-79 T</b> | <b>EV41616-91</b><br><b>EV41616-91 T</b> | <b>EV41617-10</b><br><b>EV41617-10 T</b> | <b>EV41617-65</b><br><b>EV41617-65 T</b> | <b>EV41617-72</b><br><b>EV41617-72 T</b> | <b>EV41617-78</b><br><b>EV41617-78 T</b> |
| max. opening | 7,9 mm                                   | 9,1 mm                                   | 10,3 mm                                  | 6,5 mm                                   | 7,2 mm                                   | 7,8 mm                                   |
| Force        | 150 gms                                  | 150 gms                                  | 180 gms                                  | 150 gms                                  | 150 gms                                  | 180 gms                                  |



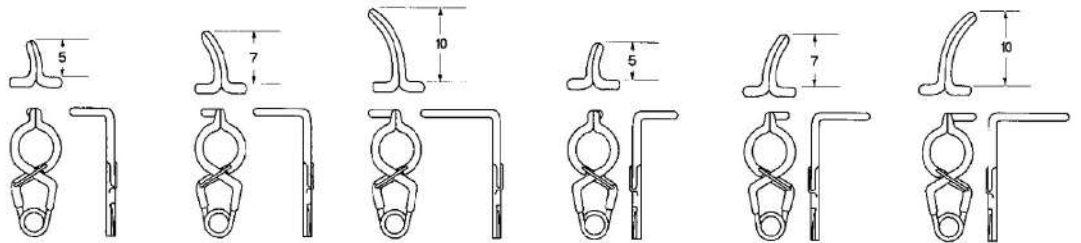
|  |  |  |  |  |  |
|--|--|--|--|--|--|
| <b>EV41618-55</b><br><b>EV41618-55 T</b> | <b>EV41618-56</b><br><b>EV41618-56 T</b> | <b>EV41618-57</b><br><b>EV41618-57 T</b> | <b>EV41618-79</b><br><b>EV41618-79 T</b> | <b>EV41618-88</b><br><b>EV41618-88 T</b> | <b>EV41619-00</b><br><b>EV41619-00 T</b> |
| 5,5 mm                                   | 5,5 mm                                   | 5,5 mm                                   | 7,9 mm                                   | 8,8 mm                                   | 10,0 mm                                  |
| 150 gms                                  | 150 gms                                  | 180 gms                                  | 150 gms                                  | 150 gms                                  | 180 gms                                  |

YASARGIL – Aneurysmen – Gefäß – Clips  
 YASARGIL – Aneurysm – Vessel – Clips  
 YASARGIL – Clips para aneurisma  
 YASARGIL – Clips per aneurisma

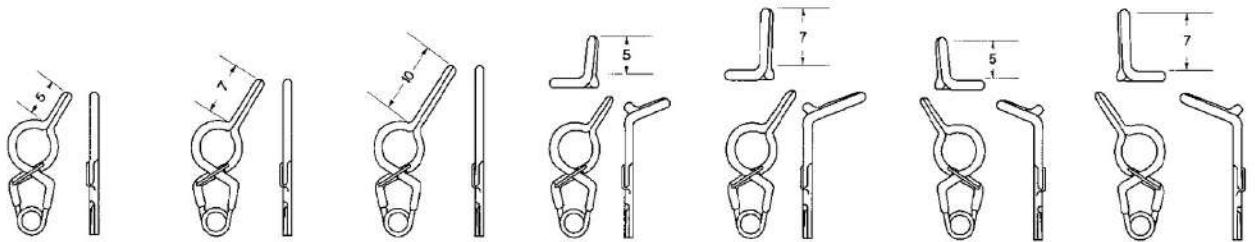
aus hochwertigem Implantat-Stahl antimagnetisch  
 in high quality Implant steel antimagnetic  
 de acero inoxidable para implantes de alta calidad, antimagnético  
 Prodotto in acciaio di alta qualità, antimagnetico

YASARGIL-STANDARD für permanenten Verschluss  
 YASARGIL-STANDARD for permanent closure  
 YASARGIL-STANDARD para cierre permanente  
 YASARGIL-STANDARD con chiusura permanente

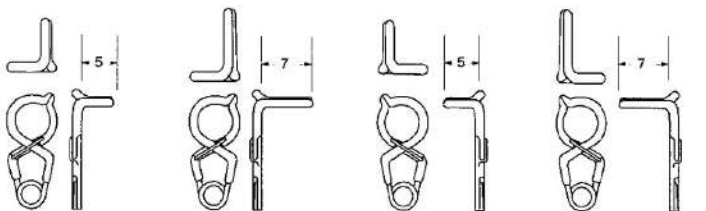
### Standard



|              |  |  |  |  |  |  |
|--------------|--|--|--|--|--|--|
| Cat. Nr.     | <b>EV41620-58</b><br><b>EV41620-58 T</b> | <b>EV41620-59</b><br><b>EV41620-59 T</b> | <b>EV41620-60</b><br><b>EV41620-60 T</b> | <b>EV41620-61</b><br><b>EV41620-61 T</b> | <b>EV41620-62</b><br><b>EV41620-62 T</b> | <b>EV41620-63</b><br><b>EV41620-63 T</b> |
| max. opening | 5,8 mm                                   | 5,8 mm                                   | 5,8 mm                                   | 5,8 mm                                   | 5,8 mm                                   | 5,8 mm                                   |
| Force        | 150 gms                                  | 150 gms                                  | 150 gms                                  | 150 gms                                  | 150 gms                                  | 150 gms                                  |



|  |  |  |  |  |  |  |
|--|--|--|--|--|--|--|
| <b>EV41620-70</b><br><b>EV41620-70 T</b> | <b>EV41620-78</b><br><b>EV41620-78 T</b> | <b>EV41620-88</b><br><b>EV41620-88 T</b> | <b>EV41621-58</b><br><b>EV41621-58 T</b> | <b>EV41621-62</b><br><b>EV41621-62 T</b> | <b>EV41622-58</b><br><b>EV41622-58 T</b> | <b>EV41622-62</b><br><b>EV41622-62 T</b> |
| 7,0 mm                                   | 7,8 mm                                   | 8,8 mm                                   | 5,8 mm                                   | 6,2 mm                                   | 5,8 mm                                   | 6,2 mm                                   |
| 150 gms                                  | 150 gms                                  | 150 gms                                  | 150 gms                                  | 150 gms                                  | 150 gms                                  | 150 gms                                  |



|  |  |  |  |
|--|--|--|--|
| <b>EV41623-56</b><br><b>EV41623-56 T</b> | <b>EV41624-56</b><br><b>EV41624-56 T</b> | <b>EV41625-56</b><br><b>EV41625-56 T</b> | <b>EV41626-56</b><br><b>EV41626-56 T</b> |
| 5,6 mm                                   | 5,6 mm                                   | 5,6 mm                                   | 5,6 mm                                   |
| 150 gms                                  | 150 gms                                  | 150 gms                                  | 150 gms                                  |

YASARGIL – Aneurysmen – Gefäß – Clips

YASARGIL – Aneurysm – Vessel – Clips

YASARGIL – Clips para aneurisma

YASARGIL – Clips per aneurisma

aus hochwertigem Implantat-Stahl antimagnetisch  
 in high quality Implant steel antimagnetic  
 de acero inoxidable para implantes de alta calidad, antimagnético  
 Prodotto in acciaio di alta qualità, antimagnetico












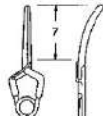





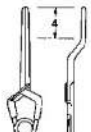
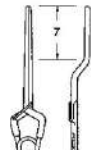

YASARGIL-STANDARD für permanenten Verschluss

YASARGIL-STANDARD for permanent closure

YASARGIL-STANDARD para cierre permanente

YASARGIL-STANDARD con chiusura permanente

## Mini

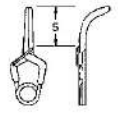
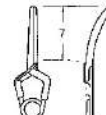
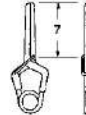
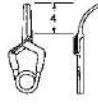
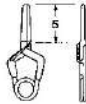
|              |   |   |   |   |  |   |   |
|--------------|---|---|---|---|--|---|---|
|              |    |    |    |   |   |    |   |
| Cat. Nr.     | <b>EV41627-33</b>   | <b>EV41627-40</b>   | <b>EV41628-33</b>   | <b>EV41628-40</b>   | <b>EV41628-46</b>  | <b>EV41629-32</b>   |   |
|              | <b>EV41627-33 T</b>   | <b>EV41627-40 T</b>   | <b>EV41628-33 T</b>   | <b>EV41628-40 T</b>   | <b>EV41628-46 T</b>  | <b>EV41629-32 T</b>   |   |
| max. opening | 3,3 mm  | 4,0 mm  | 3,3 mm  | 4,0 mm  | 4,6 mm   | 3,2 mm  |   |
| Force        | 110 gms   | 110 gms   | 110 gms   | 110 gms   | 110 gms  | 110 gms   |   |
|              |   |   |   |   |  |   |   |
|              |  |  |  |  |  |  |  |
|              | <b>EV41629-38</b>   | <b>EV41630-36</b>   | <b>EV41630-38</b>   | <b>EV41631-36</b>   | <b>EV41631-40</b>  | <b>EV41631-44</b>   | <b>EV41632-36</b>   |
|              | <b>EV41629-38 T</b>   | <b>EV41630-36 T</b>   | <b>EV41630-38 T</b>   | <b>EV41631-36 T</b>   | <b>EV41631-40 T</b>  | <b>EV41631-44 T</b>   | <b>EV41632-36 T</b>   |
|              | 3,8 mm  | 3,6 mm  | 3,8 mm  | 3,6 mm  | 4,0 mm   | 4,4 mm  | 3,6 mm  |
|              | 110 gms   | 110 gms   | 110 gms   | 110 gms   | 110 gms  | 110 gms   | 110 gms   |
|              |   |   |   |   |  |   |   |
|              |  |  |  |  |  |  |  |
|              | <b>EV41633-35</b>   | <b>EV41633-40</b>   | <b>EV41634-35</b>   | <b>EV41634-60</b>   | <b>EV41634-70</b>  | <b>EV41635-57</b>   | <b>EV41636-45</b>   |
|              | <b>EV41633-35 T</b>   | <b>EV41633-40 T</b>   | <b>EV41634-35 T</b>   | <b>EV41634-60 T</b>   | <b>EV41634-70 T</b>  | <b>EV41635-57 T</b>   | <b>EV41636-45 T</b>   |
|              | 3,5 mm  | 4,0 mm  | 3,5 mm  | 6,0 mm  | 7,0 mm   | 5,7 mm  | 4,5 mm  |
|              | 110 gms   | 110 gms   | 130 gms   | 130 gms   | 130 gms  | 130 gms   | 130 gms   |

YASARGIL – Aneurysmen – Gefäß – Clips  
 YASARGIL – Aneurysm – Vessel – Clips  
 YASARGIL – Clips para aneurisma  
 YASARGIL – Clips per aneurisma

aus hochwertigem Implantat-Stahl antimagnetisch  
 in high quality Implant steel antimagnetic  
 de acero inoxidable para implantes de alta calidad, antimagnético  
 Prodotto in acciaio di alta qualità, antimagnetico

YASARGIL-STANDARD für temporären Verschluss  
 YASARGIL-STANDARD for temporary closure  
 YASARGIL-STANDARD para cierre temporal  
 YASARGIL-STANDARD con chiusura temporanea

## Mini



|              |                            |                            |                            |                            |                            |                            |
|--------------|----------------------------|----------------------------|----------------------------|----------------------------|----------------------------|----------------------------|
| Cat. Nr.     | EV41637-33<br>EV41637-33 T | EV41637-40<br>EV41637-40 T | EV41638-38<br>EV41638-38 T | EV41638-46<br>EV41638-46 T | EV41639-44<br>EV41639-44 T | EV41640-40<br>EV41640-40 T |
| max. opening | 3,3 mm                     | 4,0 mm                     | 3,8 mm                     | 4,6 mm                     | 4,4 mm                     | 4,0 mm                     |
| Force        | 50 gms                     | 50 gms                     | 50 gms                     | 70 gms                     | 70 gms                     | 70 gms                     |

Anlegezange mit Rundgriff – FLEXIBEL – mit und ohne drehbarem Maulteil  
 Applying forceps with round shaft – FLEXIBLE – with and without Rotation  
 Pinzas de aplicación con mango redondo – FLEXIBLE – con y sin rotación  
 Posa clips con manico rotunda guaina FLESSIBILE cover sistema rotante ed non rotante

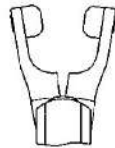
|           |            |            |
|-----------|------------|------------|
| Länge     |            |            |
| Length    |            |            |
| Largo     |            |            |
| Lunghezza | MINI       | STANDARD   |
| 70 mm     | EV41641-07 | EV41643-07 |
| 90 mm     | EV41641-09 | EV41643-09 |
| 110 mm    | EV41641-11 | EV41643-11 |

nicht drehbar  
 non rotating  
 sin rotación  
 non rotante



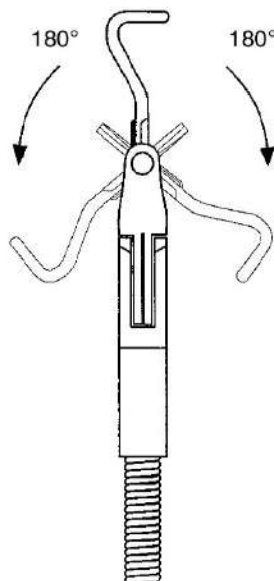
|           |            |            |
|-----------|------------|------------|
| Länge     |            |            |
| Length    |            |            |
| Largo     |            |            |
| Lunghezza | MINI       | STANDARD   |
| 70 mm     | EV41642-07 | EV41644-07 |
| 90 mm     | EV41642-09 | EV41644-09 |
| 110 mm    | EV41642-11 | EV41644-11 |

drehbar  
 rotating  
 rotante  
 rotante

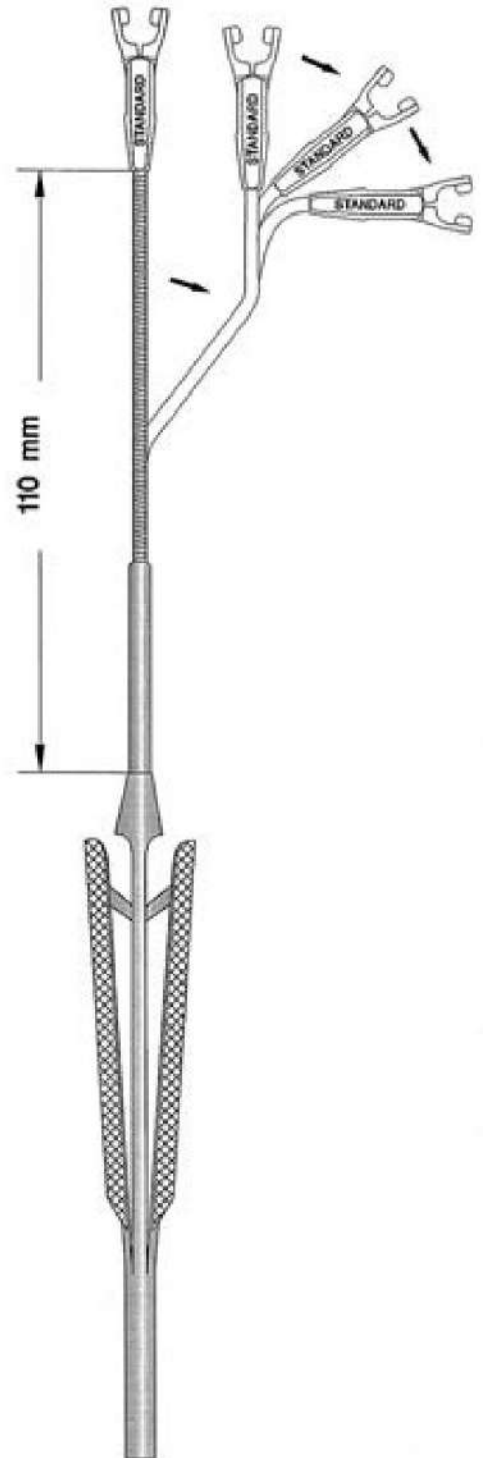


drehbar  
 rotating  
 rotante  
 rotante

Beispiel für Drehmechanismus  
 Example for Rotation  
 Ejemplo de la rotación  
 Esempio della rotazione



Clips drehbar im Maul  
 Clips rotatable in jaw  
 Clips rotabile en la boca  
 Clips rotabile nel morso

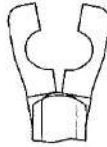


EV41641-07 - EV41644-11

Anlegezange mit Rundgriff – starr – mit und ohne drehbarem Maulteil  
 Applying forceps with round shaft – rigid – with and without Rotation  
 Pinzas de aplicación con mango redondo – rigido – con y sin rotación  
 Posa clips con manico rotonda guaina rigida cover sistema rotante ed non rotante

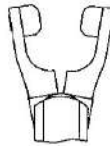
|           |            |            |
|-----------|------------|------------|
| Länge     |            |            |
| Length    |            |            |
| Largo     |            |            |
| Lunghezza | MINI       | STANDARD   |
| 70 mm     | EV41645-07 | EV41647-07 |
| 90 mm     | EV41645-09 | EV41647-09 |
| 110 mm    | EV41645-11 | EV41647-11 |

nicht drehbar  
 non rotating  
 sin rotación  
 non rotante

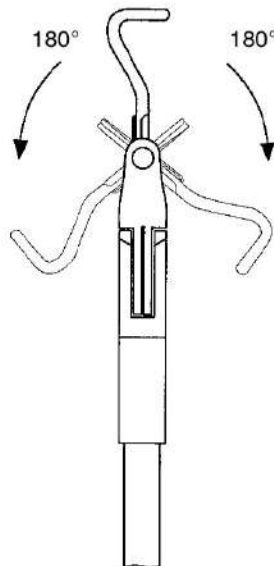


|           |            |            |
|-----------|------------|------------|
| Länge     |            |            |
| Length    |            |            |
| Largo     |            |            |
| Lunghezza | MINI       | STANDARD   |
| 70 mm     | EV41646-07 | EV41648-07 |
| 90 mm     | EV41646-09 | EV41648-09 |
| 110 mm    | EV41646-11 | EV41648-11 |

drehbar  
 rotating  
 rotante  
 rotante

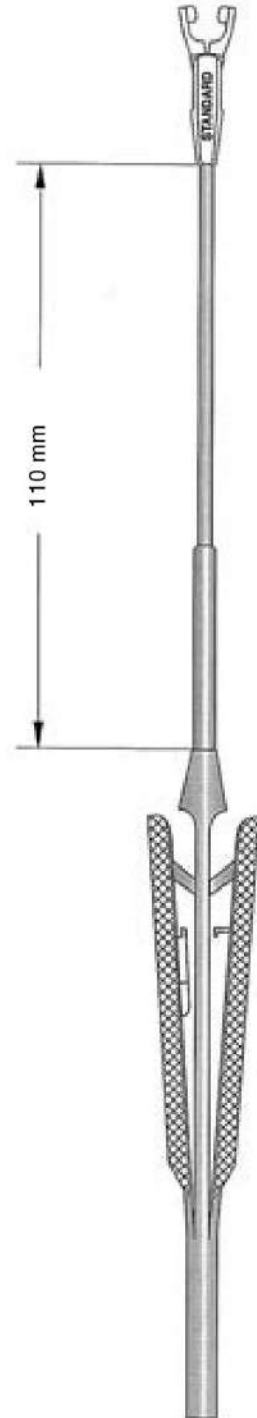


drehbar  
 rotating  
 rotante  
 rotante



Beispiel für Drehmechanismus  
 Example for Rotation  
 Ejemplo de la rotación  
 Esempio della rotazione

Clips drehbar im Maul  
 Clips rotabile in jaw  
 Clips rotabile en la boca  
 Clips rotabile nel morso

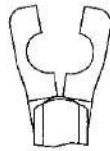


EV41645-07 - EV41648-11

Anlegezange mit Rundgriff – starr – mit und ohne drehbarem Maulteil  
 Applying forceps with round shaft – rigid – with and without Rotation  
 Pinzas de aplicación con mango redondo – rigido – con y sin rotación  
 Posa clips con manico rotonda guaina rigida cover sistema rotante ed non rotante

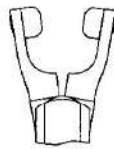
|           |            |            |
|-----------|------------|------------|
| Länge     |            |            |
| Length    |            |            |
| Largo     |            |            |
| Lunghezza | MINI       | STANDARD   |
| 70 mm     | EV41649-07 | EV41651-07 |
| 90 mm     | EV41649-09 | EV41651-09 |
| 110 mm    | EV41649-11 | EV41651-11 |

nicht drehbar  
 non rotating  
 sin rotación  
 non rotante

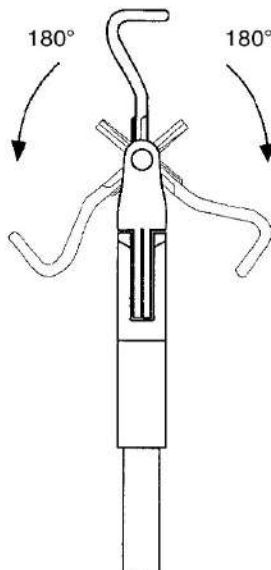


|           |            |            |
|-----------|------------|------------|
| Länge     |            |            |
| Length    |            |            |
| Largo     |            |            |
| Lunghezza | MINI       | STANDARD   |
| 70 mm     | EV41650-07 | EV41652-07 |
| 90 mm     | EV41650-09 | EV41652-09 |
| 110 mm    | EV41650-11 | EV41652-11 |

drehbar  
 rotating  
 rotante  
 rotante

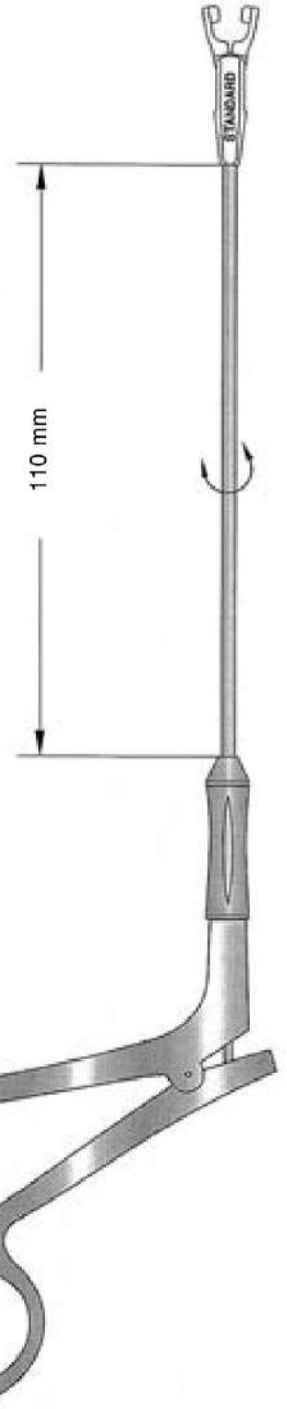


drehbar  
 rotating  
 rotante  
 rotante



Beispiel für Drehmechanismus  
 Example for Rotation  
 Ejemplo de la rotación  
 Esempio della rotazione

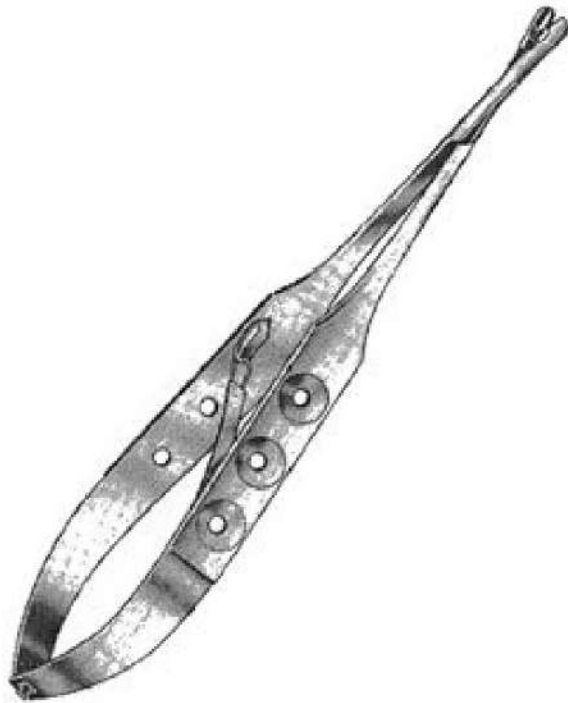
Clips drehbar im Maul  
 Clips rotabile in jaw  
 Clips rotabile en la boca  
 Clips rotabile nel morso



EV41649-07 - EV41652-11



Anlegezange – mit und ohne drehbarem Maulteil  
 Applying Forceps – with and without Rotation  
 Pinzas de aplicación, con y sin rotación  
 Pinza posa clips, con ed senza rotazione



|          |  |
|----------|--|
| MINI     | EV41653-18   |
| STANDARD | EV41654-18   |
| MINI     | EV41655-18 drehbar / rotating<br>rotante / rotante |
| STANDARD | EV41656-18 drehbar / rotating<br>rotante / rotante |

Anlegezange gerade, mit Sperre, Länge 18 cm, 7" Applying  
 Forceps straight, with Ratchet, Lenght 18 cm, 7" Pinza de  
 aplicación, con cremallera, 18 cm, 7"  
 Posa clips, retta con bloccaggio lunghezza 18 cm, 7"

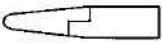




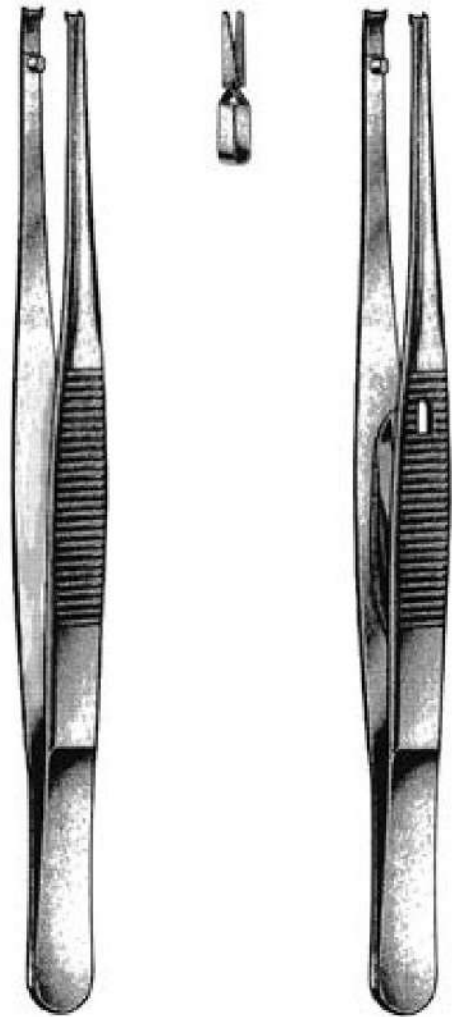
|           |                    |                     |            |
|-----------|--------------------|---------------------|------------|
| Länge     |                    |                     |            |
| Lenght    |                    |                     |            |
| Largo     |                    |                     |            |
| Lunghezza | 17 cm, 6 3/4"      | 21 cm, 8 1/4"       | 23 cm, 9"  |
| MINI      | EV41657-17         | EV41657-21          | EV41657-23 |
| STANDARD  | EV41658-17         | EV41658-21          | EV41658-23 |
| MINI      | EV41659-17         | EV41659-21          | EV41659-23 |
|           | drehbar / rotating | / rotante / rotante |            |
| STANDARD  | EV41660-17         | EV41660-21          | EV41660-23 |
|           | drehbar / rotating | / rotante / rotante |            |

Clips drehbar im Maul  
 Clips rotatable in jaw  
 Clips rotatable en la boca  
 Clips rotabile nel morso

Anlegezange bayonett, mit Sperre  
 Applying Forceps bajonett, with Ratchet  
 Pinza de aplicación bayoneta, con cremallera  
 Posa clips a baionetta con bloccaggio

Gefäßclips nach BIEMER  
 BIEMER Vessel Clips  
 Clips para vasos de BIEMER  
 Clips per vasi secondo BIEMER

|   | Maulöffnung<br>Opening | Maullänge<br>Length<br>of jaws | Schließkraft<br>Closing<br>Force |
|---|------------------------|--------------------------------|----------------------------------|
| <br>EV41661-40 | 4,0 mm                 | 6,0 mm                         | 30 - 40 g<br>(0,29 - 0,39 N)     |
| <br>EV41661-50 | 5,0 mm                 | 9,0 mm                         | 30 - 40 g<br>(0,29 - 0,39 N)     |
| <br>EV41662-50 | 5,0 mm                 | 9,0 mm                         | 20 - 25 g<br>(0,20 - 0,25 N)     |



für temporären Gebrauch

gekennzeichnet durch gelb eingefärbte Federenden für Gefäße mit einem Durchmesser 0,5 - 2,0 mm

Maulinnenflächen schräg gerieft für schonendes, sicheres Festhalten der Gefäße

Der fest eingestellte Schließdruck gewährt risikofreie Anwendung

for temporary occlusion

(identified by yellow coloured spring ends) for vessel diam. 0,5 - 2,0 mm

Blade gripping surface with oblique serrations for save but careful gripping of vessels

No risk due to rigidly fixed pressure measure

para uso temporal

clips marcados con baño dorado en los resortes, para vasos con un diámetro de 0,5 - 2,0 mm

El interior de las quijadas viene con estrias finas para un agarre seguro y cuidadoso de los vasos

Debido a la calibración exacta de la fuerza de cierre se ofrece una aplicación sin riesgo

per chiusura temporanea

per vasi con Diametro 0,5 - 2,0 mm

La chiusura regolata garantisce nessun rischio

BIEMER  
EV41663-01

Anlegepinzette ohne Schloß,  
für Mikro-Gefäßclips  
EV41661-40 - EV41662-50  
und  
Approximatoren  
EV41667-30 - EV41670-50  
und  
EV41672-01 - EV41672-04

Applying forceps without lock,  
for vessel clips  
EV41661-40 - EV41662-50  
and  
Aproximators  
EV41667-30 - EV41670-50  
and  
EV41672-01 - EV41672-04

BIEMER  
EV41663-02

Anlegepinzette mit Schloß,  
für Mikro-Gefäßclips  
EV41661-40 - EV41662-50  
und  
Approximatoren  
EV41667-30 - EV41670-50  
und  
EV41672-01 - EV41672-04

Applying forceps with lock,  
for vessel clips  
EV41661-40 - EV41662-50  
and  
Aproximators  
EV41667-30 - EV41670-50  
and  
EV41672-01 - EV41672-04

Gefäßclips nach MEHDORN  
MEHDORN Vessel Clips  
Clips para vasos de MEHDORN  
Clips secondo MEHDORN

für temporären Gebrauch

gekennzeichnet durch gelb eingefärbte Federenden für Gefäße mit einem Durchmesser 0,5 - 1,5 mm

Maulinnenflächen schräg gerieft für schonendes, sicheres Festhalten der Gefäße

Der fest eingestellte Schließdruck gewährt risikofreie Anwendung

for temporary occlusion

(identified by yellow coloured spring ends) for vessel diam. 0,5 - 1,5 mm

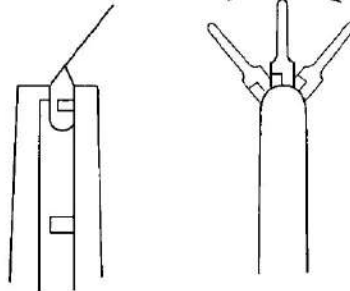
Blade gripping surface with oblique serrations for save but careful gripping of vessels

No risk due to rigidly fixed pressure measure

Beispiele für die variable Position des Clips

Ejemplo para la variedad de la aplicación del clip

Esempio: posizioni variabili delle clips



para uso temporal

clips marcados con baño dorado en los resortes, para vasos con un diámetro de 0.5 - 1.5 mm

El interior de las quijadas viene con estrias finas para un agarre seguro y cuidadoso de los vasos

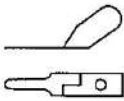
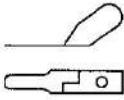
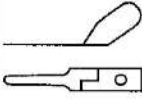

Debido a la calibración exacta de la fuerza de cierre se ofrece una aplicación sin riesgo

per chiusura temporanea

per vasi con Diametro 0,5 - 1,5 mm

La chiusura regolata garantisce nessun rischio



|   | Maullänge<br>Length of jaws<br>Largo de la boca<br>Lunghezza del morso | Schließkraft<br>Closing Force<br>Fuerza del cierre<br>Forza di chiusura | MEHDORN<br>EV41666-00<br><br>Anlegepinzette für Mikro-Gefäß-<br>clips<br>EV41664-10 - EV41665-14<br><br>Applying Forceps for vessel clips<br>EV41664-10 - EV41665-14<br><br>Pinza de aplicación para micro-<br>clips<br>EV41664-10 - EV41665-14<br><br>Pinza posa clips per microvasi<br>EV41664-10 - EV41665-14 |
|---|--|---|--|
|  | EV41664-10 4 x 1,0 mm  | 10 - 15 g<br>(0,10 - 0,15 N)  |  |
|  | EV41664-14 4 x 1,4 mm  | 15 - 20 g<br>(0,15 - 0,20 N)  |  |
|   | EV41665-10 6 x 1,0 mm  | 10 - 15 g<br>(0,10 - 0,15 N)  |  |
|   | EV41665-14 6 x 1,4 mm  | 15 - 20 g<br>(0,15 - 0,20 N)  |  |

Approximatoren nach Biemer-Müller  
 Approximators Biemer-Müller  
 Aproximadores de Biemer-Müller  
 Approssimatore secondo Biemer-Müller

für temporären Gebrauch

gekennzeichnet durch gelb eingefärbte Federenden für Gefäße mit einem Durchmesser 0,5 - 2,0 mm  
 Maulinnenflächen schräg gerieft für schonendes, sicheres Festhalten der Gefäße  
 Der fest eingestellte Schließdruck gewährt risikofreie Anwendung

for temporary occlusion

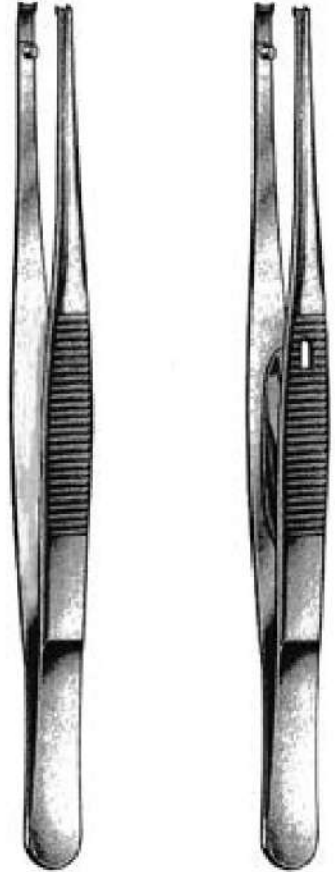
(identified by yellow coloured spring ends) for vessel diam. 0,5 - 2,0 mm  
 Blade gripping surface with oblique serrations for save but careful gripping of vessels  
 No risk due to rigidly fixed pressure measure

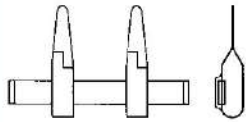
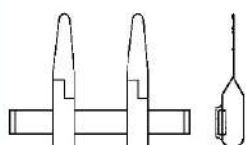
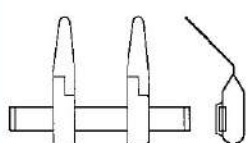
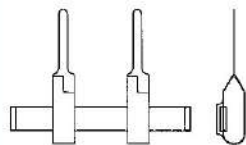
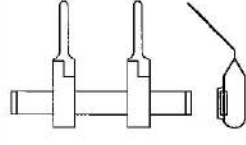
para uso temporal

clips marcados con baño dorado en los resortes, para vasos con un diámetro de 0,5 - 2,0 mm  
 El interior de las quijadas viene con estrias finas para un agarre seguro y cuidadoso de los vasos  
 Debido a la calibración exacta de la fuerza de cierre se ofrece una aplicación sin riesgo

per chiusura temporanea

per vasi con Diametro 0,5 - 2,0 mm  
 La chiusura regolata garantisce nessun rischio



|   | Maulöffnung<br>Opening                          | Maullänge<br>Length<br>of jaws                | Schließkraft<br>Closing<br>Force             |   |
|---|---|---|--|---|
|   | Apertura de<br>la boca<br>Apertura del<br>morso | Largo de<br>la boca<br>Lunghezza<br>del morso | Fuerza del<br>cierre<br>Forza di<br>chiusura |   |
|  | 3,0 mm  | 4,5 mm  | 30 - 40 g<br>(0,29 - 0,39 N)                 | BIEMER<br>EV41663-01  |
|  | 5,0 mm  | 9,0 mm  | 30 - 40 g<br>(0,29 - 0,39 N)                 | Anlegepinzette ohne Schloß,<br>für Mikro-Gefäßclips<br>EV41661-40 - EV41662-50<br>und Approximatoren<br>EV41667-30 - EV41670-50<br>und<br>EV41672-01 - EV41672-04 |
|  | 5,0 mm  | 9,0 mm  | 30 - 40 g<br>(0,20 - 0,25 N)                 | Anlegepinzette mit Schloß,<br>für Mikro-Gefäßclips<br>EV41661-40 - EV41662-50<br>und Approximatoren<br>EV41667-30 - EV41670-50<br>und<br>EV41672-01 - EV41672-04  |
|  | 5,0 mm  | 9,0 mm  | 30 - 40 g<br>(0,20 - 0,25 N)                 |   |
|  | 5,0 mm  | 9,0 mm  | 30 - 40 g<br>(0,20 - 0,25 N)                 |   |

**für temporären Gebrauch**

gekennzeichnet durch gelb eingefärbte Federenden für Gefäße mit einem Durchmesser 0,5 - 2,0 mm  
Maulinnenflächen schräg gerieft für schonendes, sicheres Festhalten der Gefäße  
Der fest eingestellte Schließdruck gewährt risikofreie Anwendung

**for temporary occlusion**

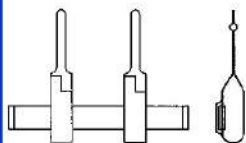
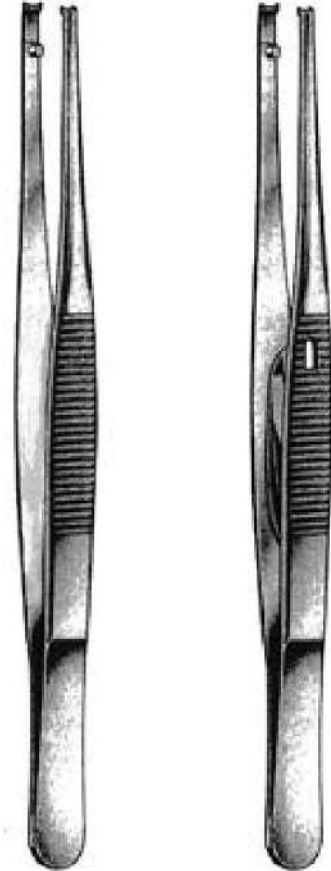
(identified by yellow coloured spring ends) for vessel diam. 0,5 - 2,0 mm  
Blade gripping surface with oblique serrations for save but careful gripping of vessels  
No risk due to rigidly fixed pressure measure

**para uso temporal**

clips marcados con baño dorado en los resortes, para vasos con un diámetro de 0,5 - 2,0 mm  
El interior de las quijadas viene con estrias finas para un agarre seguro y cuidadoso de los vasos  
Debido a la calibración exacta de la fuerza de cierre se ofrece una aplicación sin riesgo

**per chiusura temporanea**

per vasi con Diametro 0,5 - 2,0 mm  
La chiusura regolata garantisce nessun rischio



EV41672-01

Ø  
Diameter

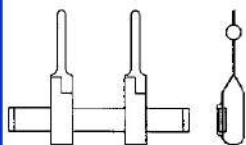
1,0 mm

Schließkraft  
Closing Force  
Fuerza del cierre  
Forza di chiusura

25 - 30 g  
(0,25 - 0,29 N)

BIEMER  
EV41663-01

BIEMER  
EV41663-02



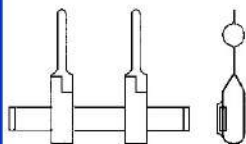
EV41672-02

2,0 mm

25 - 30 g  
(0,25 - 0,29 N)

Anlegepinzette ohne Schloß, für Mikro-Gefäßclips EV41661-40 - EV41662-50 und Approximatoren EV41667-30 - EV41670-50 und EV41672-01 - EV41672-04

Anlegepinzette mit Schloß, für Mikro-Gefäßclips EV41661-40 - EV41662-50 und Approximatoren EV41667-30 - EV41670-50 und EV41672-01 - EV41672-04



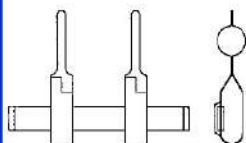
EV41672-03

3,0 mm

25 - 30 g  
(0,25 - 0,29 N)

Applying forceps without lock for vessel clips EV41661-40 - EV41662-50 and Aproximators EV41667-30 - EV41670-50 and EV41672-01 - EV41672-04

Applying forceps with lock for vessel clips EV41661-40 - EV41662-50 and Aproximators EV41667-30 - EV41670-50 and EV41672-01 - EV41672-04



EV41672-04

4,0 mm

25 - 30 g  
(0,25 - 0,29 N)

Gefäßclips nach Müller  
Müller Vessel Clips  
Clips para vasos de Müller  
Clip secondo Müller

für temporären Gebrauch

Maulinnenflächen pyramidenförmig für schonendes, sicheres Festhalten der Gefäße

Der fest eingestellte Schließdruck gewährt risikofreie Anwendung

for temporary occlusion

Blade gripping surface with pyramid-like impressions for save but careful gripping of vessels

No risk due to rigidly fixed pressure measure

para uso temporal

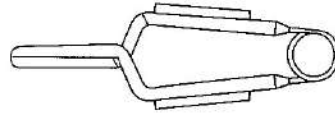
El interior de las quijadas viene en forma de pirámide para un agarre seguro y cuidadoso de los vasos.

Debido a la calibración exacta de la fuerza de cierre se ofrece una aplicación sin riesgo.

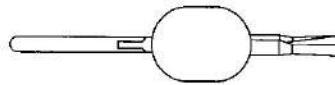
per uso temporaneo

Morso interno con forma piramidale per garantire una chiusura sicura del vaso

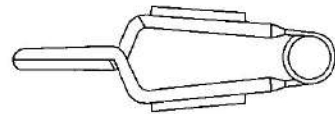
Schließkraft  
Closing Force  
Fuerza del cierre  
Forza di chiusura



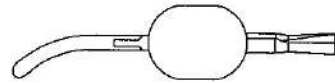
EV41674-50 50 g



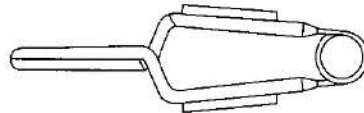
EV41674-80 80 g



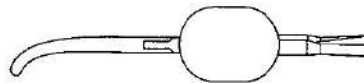
EV41675-50 50 g



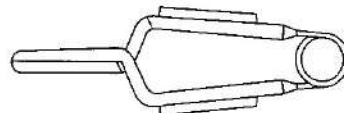
EV41675-80 80 g



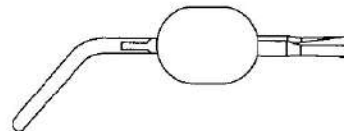
EV41676-50 50 g



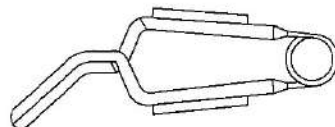
EV41676-80 80 g



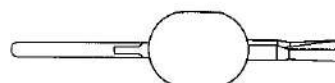
EV41677-50 50 g



EV41677-80 80 g



EV41678-50 50 g



EV41678-80 80 g

Approximator nach Biemer  
 Biemer Approximator  
 Aproximadores de Biemer  
 Approssimatore secondo Biemer

für Mikro-Gefäßanastomosen im oberflächlichen Bereich

Maulinnenflächen schräg gerieft für schonendes, sicheres Festhalten der Gefäße

Der fest eingestellte Schließdruck gewährt risikofreie Anwendung

Der Abstand zwischen den Clips ist durch einfaches Verschieben einzustellen und wird durch Verkanten fixiert

for micro vessel anastomosis in the superficial range

Blade gripping surface with oblique serrations for save but careful gripping of vessels

No risk due to rigidly fixed pressure measure

Adjustable distance between the clips and automatic fixation by tilting

para micro-anastomosis en la superficie

El interior de la quijada viene con estrias finas para un agarre seguro y cuidadoso de los vasos.

Debido a la calibración exacta de la fuerza de cierre se ofrece una aplicación sin riesgo.

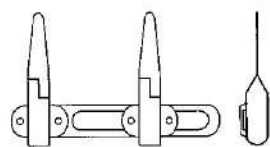
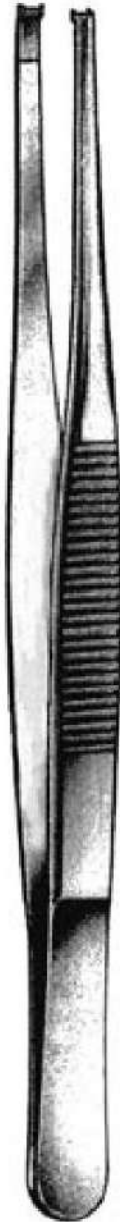
El espacio entre los clips se logra fácilmente por el desplazamiento.

per micro vasi anastomosi sulla parte della superficie

Parte interna del morso è leggermente striata obliqua per ottenere la presa sulla superficie del vaso.

La chiusura regolata garantisce nessun rischio.

Lo scorrimento delle due clips viene regolato con semplice movimento che consente una chiusura ottimale.



EV41679-25

Schließkraft  
 Closing Force  
 Fuerza de cierre  
 Forza di chiusura

25 - 30 g  
 (0,25 - 0,29 N)

BIEMER  
 EV41680-00

Anlegepinzette für Gefäß-Approximator nach BIEMER

Applying forceps for BIEMER vessel approximator

Pinza de aplicación para aproximadores de BIEMER

Pinza posa clips per vasi approssimatori secondo BIEMER

LEYLA Retraktor System  
 LEYLA Retractor System  
 Separador de sistema LEYLA  
 LEYLA Sistema di fissaggio

YASARGIL



- EV41801-01 Hirnspatelhalter, flexibel, für 1 flachen Spatel, komplett, bestehend aus:  
 brain retractor, flexible, for 1 flat spatula, complete, consisting of:  
 separador autoretentivo, flexible, para espátula con 1 brazo flexible, completo, compuesto de:  
 divaricatore autostatico, flessibile, per spatole piatte, con 1 braccio flessibile, completo, composto da:
- EV41810-10 flexibler Spannarm  
 flexible arm  
 brazo flexible  
 braccio flessibile
- EV41826-26 Fixiervorrichtung für 1 flexiblen Spannarm  
 fixation base for 1 flexible arm  
 fijador para 1 brazo flexible  
 fissatore per 1 braccio al braccio rigido
- EV41830-30 Spatelhalter für flache Spatel  
 support for flat brain spatula  
 soporte para espátulas cerebrales planas  
 sostegno per spatole piatte

YASARGIL



- EV41802-02 Hirnspatelhalter, flexibel für 2 flache Spatel, komplett, bestehend aus:  
 brain retractor, flexible, for 2 flat spatulas, complete, consisting of:  
 separador autoretentivo, flexible, para 2 espátulas planas con 2 brazos flexibles, completo, compuesto de:  
 divaricatore autostatico, flessibile, per spatole piatte, con 2 bracci flessibili, completo, composto da:
- EV41810-10 flexibler Spannarm (2x)  
 flexible arm (2x)  
 brazo flexible (2x)  
 braccio flessibile (2x)
- EV41822-22 Fixiervorrichtung für 2 flexible Spannarme  
 fixation base for 2 flexible arms  
 fijador para 2 brazos  
 fissatore per 2 bracci al cranio
- EV41830-30 Spatelhalter für flache Spatel (2x)  
 support for flat brain spatula (2x)  
 soporte para espátulas cerebrales planas (2x)  
 sostegno per spatole piatte (2x)



EV41821-21

Fixiervorrichtung für 1 flexiblen Spannarm zum Festschrauben an Rohrteilen bis  
 ø 16 mm

Fixation base for mounting on bars up to ø16 mm, for 1 flexible arm

Fijador para 1 brazo flexible, para atornillar a tubos hasta 16 mm

Fissatore per 1 braccio al braccio rigido



EV41822-22

Fixiervorrichtung für 2 flexible Spannarme zum Festschrauben am Schädel

Fixation base for skull mounting, holding 2 flexible arms

Fijador para 2 brazos flexibles, para atornillar al craneo

Fissatore per 2 bracci al cranio



EV41826-26

Fixiervorrichtung für 1 flexiblen Spannarm zum Festschrauben am Schädel

Fixation base for skull mounting, holding 1 flexible arm

Fijador para 1 brazos flexibles, para atornillar al craneo

Fissatore per 1 braccio al cranio



EV41830-30

Spatelhalter für flache Hirnspatel zur Befestigung am Spannarm

Support for flat brain spatula

Soporte para espátulas cerebrales planas para fijacion al brazo flexible

Sostegno per spatole piatte



EV41832-32

Halter für Hirnspatel mit rundem Schaft bis ø 5,5 mm zur Befestigung am  
 Spannarm

Support for brain spatula with round shaft

Soporte para espátulas cerebrales con mango redondo hasta ø 5,5 mm para  
 fijacion al brazo flexible

Sostegno flessibile per spatola cerebrale



LEYLA Retraktor System  
 LEYLA Retractor System  
 Separador de sistema LEYLA  
 LEYLA Sistema di fissaggio



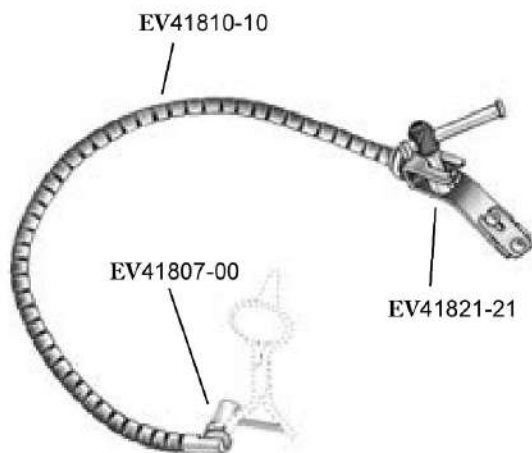
EV41810-10

YASARGIL

EV41810-10 flexibler Spannarm, allein  
 flexible arm, only  
 brazo flexible, suelto  
 braccio flessibile, solo

YASARGIL

EV41803-01 Ohrspekulahalter, komplett, bestehend aus:  
ear specula holder, complete, consisting of:  
soporte para espejos auriculares completo,  
compuesto de:  
sostegno per specchio auricolare, completo  
composto da:



EV41810-10

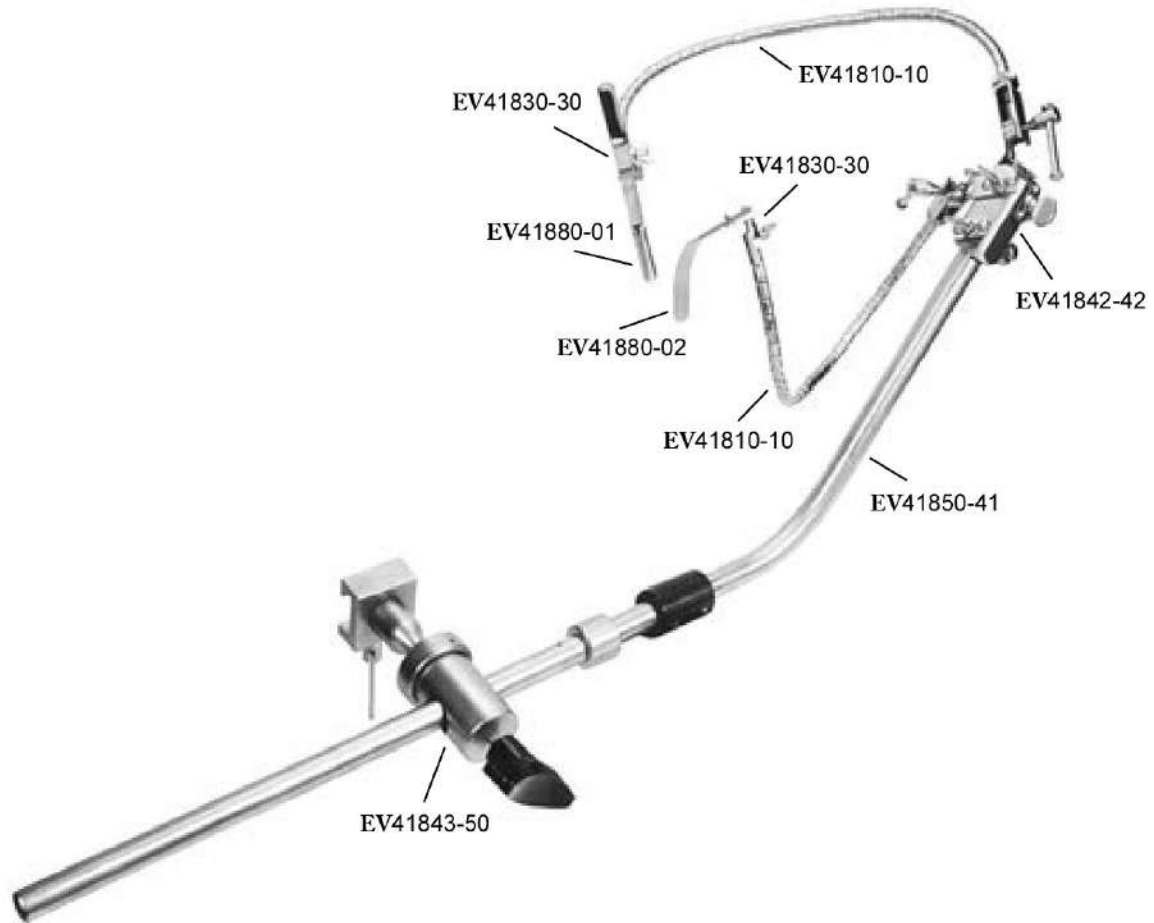
EV41807-00

EV41821-21

EV41810-10 flexibler Spannarm  
 flexible arm, only  
 brazo flexible, suelto  
 braccio flessibile, solo

EV41821-21 Fixiervorrichtung zum Befestigen an Rohrteilen  
bis Ø 16 mm  
clamp for fixation on bars up to Ø 16 mm  
fijador para 1 brazo flexible, para atornillar a  
tubos hasta 16 mm  
fissatore al braccio rigido Ø 16 mm

EV41807-00 Ohrtrichterhalter, allein  
ear specula holder, only  
soporte para espejos auriculares, suelto  
sostegno per specchio auricolare



EV41802-00 LEYLA-Retraktor-System zum Fixieren am OP-Tisch komplett, bestehend aus:  
 LEYLA Self-Retraining Retractor for fixation to operating table, complete, consisting of:  
 Separador LEYLA para fijación a la mesa de operaciones, completo, compuesto de:  
 LEYLA Sistema di fissaggio al tavolo operatorio, composto da:

- |            |  |            |   |
|------------|--|------------|---|
| EV41843-50 | Kugelgelenkkloben (1x)<br>ball and socket joint (1x)<br>articulacion esferica (1x)<br>giunto per fissare (1x)        | EV41830-30 | Spatelhalter für flache Spatel (2x)<br>support for flat brain spatula (2x)<br>soporte para espátulas cerebrales planas (2x)<br>sostegno per spatole piatte (2x) |
| EV41850-41 | starrer Haltearm (1x)<br>rigid holding rod (1x)<br>brazo de fijación rigido (1x)<br>braccio di fissaggio rigido (1x) | EV41880-01 | CUSHING Hirnspatel (1x)<br>CUSHING brain spatula (1x)<br>CUSHING espatula para cerebro (1x)<br>CUSHING spatola cerebrale (1x)                                   |
| EV41842-42 | Kupplungskopf (1x)<br>coupling head (1x)<br>cabeza de acoplamiento (1x)<br>giunto per combinare (1x)                 | EV41880-02 | CUSHING Hirnspatel (1x)<br>CUSHING brain spatula (1x)<br>CUSHING espatula para cerebro (1x)<br>CUSHING spatola cerebrale (1x)                                   |
| EV41810-10 | flexibler Spannarm (2x)<br>flexible arm, only (2x)<br>brazo flexible, suelto (2x)<br>braccio flessibile, solo (2x)   |            |   |

LEYLA Retraktor System  
 LEYLA Retractor System  
 Separador de sistema LEYLA  
 LEYLA Sistema di fissaggio



EV41843-50

Kugelgelenkkloben  
 zum Befestigen an der OP-Tisch-  
 schiene und zur Aufnahme des  
 Haltearms 41850-41  
 ball and socket joint  
 for fixation of holding rod 41850-41 at  
 the operating table  
 articulacion esferica, para sujetar el  
 brazo de soporte rigido sobre la mesa  
 de operaciones 9 x 32 mm  
 giunto per fissare il braccio, art-  
 icolato 9 x 32 mm



EV41850-41

starrer Haltearm, auseinandernehmbar, zur Fixation im  
 Kugelgelenkkloben EV41843-50 und zur wahlweisen  
 Aufnahme der Kupplungsköpfe EV41842-42,  
 EV41842-44 und EV41842-46  
 holding rod, detachable, for fixation in ball and socket  
 joint EV41843-50 and to hold a desired coupling  
 head EV41842-42, EV41842-44 or EV41842-46  
 brazo de soporte rigido, desmontable, para fijacion a la  
 articulacion esferica EV41843-50 y opcionalmente a  
 las cabezas EV41842-42, EV41842-44 y EV41842-46  
 braccio di sostegno rigido, per fissaggio al giunto  
 EV41843-50 e dei giunti EV41842-42, EV41842-44 e  
 EV41842-46



EV41842-42

Kupplungskopf, zur Aufnahme von  
 max. 5 flexiblen Spannarmen  
 EV41810-10  
 coupling head to hold 5 flexible  
 arms EV41810-10  
 cabeza de acoplamiento para fijar  
 hasta 5 brazos flexibles  
 giunto per combinare 5 bracci



EV41842-4

Kupplungskopf, drehbar, zur Aufnahme von 1 flexiblen  
 Spannarm EV41810-10  
 coupling head, turnable, to hold 1 flexible arm EV41810-10  
 acoplamiento, girable y se puede fijar en todas las pos-  
 turas para sujetar un brazo flexible EV41810-10  
 giunto per combinare, rotabile, per sostegno del braccio  
 EV41810-10

EV41842-46

Kupplungskopf, seitlich offen zur Aufnahme von 1 flexi-  
 blen Spannarm EV41810-10  
 coupling head, lateral open, to hold 1 flexible arm  
 EV41810-10  
 acoplamiento, abierto al lado, para un brazo flexible  
 EV41810-10  
 giunto per fissare il braccio, per EV41810-10

Hirnspatel  
Brain Spatulas  
Espátula Cerebral  
Spatole Cerebrali



HEIFETZ  
200 mm  
8"

|            | Breite<br>width<br>ancho<br>larghezza | Gesamtlänge<br>total length<br>largo total<br>lunghezza totale |
|------------|---------------------------------------|--|
| EV41860-14 | 14 mm                                 | 200 mm   |
| EV41860-17 | 17 mm                                 | 200 mm   |
| EV41860-20 | 20 mm                                 | 200 mm   |



biegsam  
malleable  
maleable  
malleabili



HEIFETZ  
155 mm  
6"

|            | Breite<br>width<br>ancho<br>larghezza | Gesamtlänge<br>total length<br>largo total<br>lunghezza totale |
|------------|---------------------------------------|--|
| EV41870-08 | 8 mm                                  | 155 mm   |
| EV41870-11 | 11 mm                                 | 155 mm   |
| EV41870-14 | 14 mm                                 | 155 mm   |
| EV41870-17 | 17 mm                                 | 155 mm   |

|            | Breite<br>width<br>ancho<br>larghezza | Gesamtlänge<br>total length<br>largo total<br>lunghezza totale |
|------------|---------------------------------------|--|
| EV41880-01 | 9 mm                                  | 200 mm   |
| EV41880-02 | 12 mm                                 | 200 mm   |
| EV41880-03 | 12 mm                                 | 250 mm   |

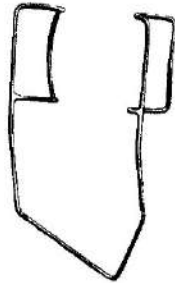


biegsam  
malleable  
maleable  
malleabili

CUSHING  
200 mm, 8"

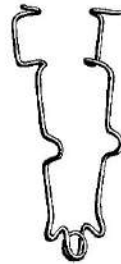
Lidsperrer  
Eye Specula  
Blefaróstatos  
Blefarostati

GERNAL SURGICAL

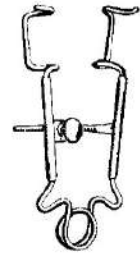


BARRAQUER (Colibri)

EV43101-03 3 cm, 1.2" für Kinder / children / niños / bambini  
EV43101-04 4 cm, 1.6" für Erwachsene / adults / adultos / adulti



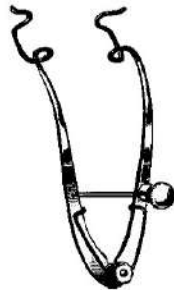
BOWMAN  
EV43104-07 7 cm, 2 3/4"



CRITCHETT  
EV43105-06 7 cm, 2 3/4"



SMITH  
EV43106-05 5 cm, 2"



CLARK  
EV43107-08 8 cm, 3 1/8"

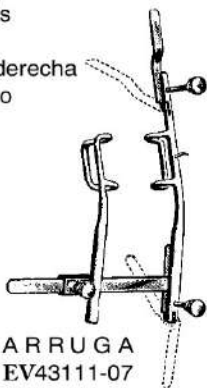


GRAEFE  
EV43109-07 7 cm, 2 3/4"  
EV43109-09 9 cm, 3 1/2"



WEEK  
EV43110-08 8 cm, 3 1/8"

rechts  
right  
a la derecha  
destro

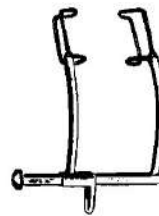


ARRUGA  
EV43111-07 7 cm, 2 3/4"

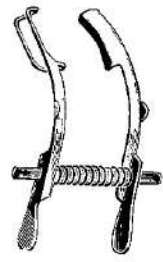
links  
left  
a la izquierda  
sinistro



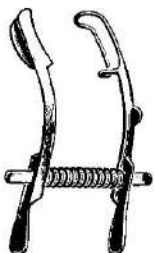
ARRUGA  
EV43113-07 7 cm, 2 3/4"



MURDOCK  
EV43115-05 5 cm, 2"



MELLINGER-AXENFELD  
EV43121-07 7 cm, 2 3/4"



MELLINGER-AXENFELD  
EV43123-07 7 cm, 2 3/4"



MELLINGER  
EV43125-05 5 cm, 2"  
EV43125-07 7 cm, 2 3/4"



LISTER-BURCH  
EV43127-08 8 cm, 3 1/8"



WILLIAMS  
EV43128-08 8 cm, 3 1/8"

Lidsperrer, Lidplatte, Starmesser  
 Eye Specula, Lid Plate, Cataract Knives  
 Blefaróstatos, Placa para párpados, cuchillos para cataratas  
 Blefarostati, Placca per palpebre, coltelli per cataratta



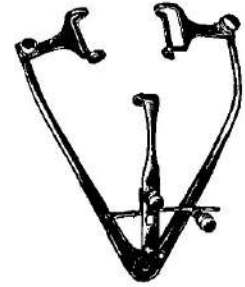
LANCASTER  
 EV43129-07  
 7 cm, 2 3/4"



ZIEGLER  
 EV43130-07  
 7 cm, 2 3/4"



CASTROVIEJO  
 EV43132-08  
 8 cm, 3 1/8"



PARK  
 EV43133-08  
 8 cm, 3 1/8"



MUELLER  
 EV43135-07  
 7 cm, 2 3/4"



STEVENSON  
 EV43139-07  
 7 cm, 2 3/4"



LIEBERMAN  
 EV43140-08  
 8 cm 3 1/8"



LIEBERMAN  
 EV43141-08  
 8 cm 3 1/8"



JAEGER  
 EV43150-11  
 11 cm, 4 3/8"



GRAEFE  
 EV43170-00 - EV43170-03  
 13 cm, 5 1/8"



EV43170-00



EV43170-01



EV43170-02

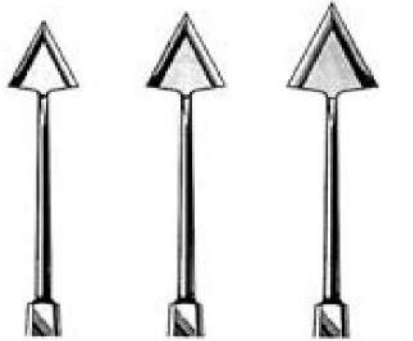


EV43170-03



DEUTSCHMANN  
 EV43172-13  
 13 cm, 5 1/8"

Lanzenmesser, Diszisionsmesser, Irismesser, Diszisionsmesser  
 Cataract knife, keratome, Iris knife, discision knife  
 Cuchillos lanceolares y Cuchillos de discisión  
 Cheratom, bisturi p. capsule, bisturi corneale



**JAEGER**  
 EV43180-01 Fig. 1 13 cm, 5 1/8"  
 EV43180-02 Fig. 2 13 cm, 5 1/8"  
 EV43180-03 Fig. 3 13 cm, 5 1/8"



**JAEGER 45°**  
 EV43181-01 Fig. 1 13 cm, 5 1/8"  
 EV43181-02 Fig. 2 13 cm, 5 1/8"  
 EV43181-03 Fig. 3 13 cm, 5 1/8"



**BERENS**  
 EV43183-13  
 13 cm, 5 1/8"



**CASTROVIEJO**  
 EV43185-13 13 cm  
 4 x 13 mm



**GRAEFE**  
 EV43187-13 13 cm, 5 1/8"



**KNAPP**  
 EV43202-01 Fig. 1 13 cm, 5 1/8"  
 EV43202-02 Fig. 2 13 cm, 5 1/8"  
 EV43202-03 Fig. 3 13 cm, 5 1/8"

EV43180-01 -  
 EV43181-03



**ZIEGLER**  
 EV43210-01 5 mm Fig. 1  
 13 cm, 5 1/8"



**ZIEGLER**  
 EV43210-02 6 mm Fig. 2  
 13 cm, 5 1/8"



**ZIEGLER**  
 EV43210-03 7 mm Fig. 3  
 13 cm, 5 1/8"



**DEAN**  
 EV43213-12  
 12,5 cm, 5"



Hornhautmesser, Hornhautschaber, Dissektor, Sklerotom, Goniotomiemesser  
 Corneal Scarifier, -dissector, sclerotome, goniotomy knife  
 Cuchillos para cornea, legtras corneales, esclerótomos  
 Spatole p. corneale, dissettore corneale, sclerotomo, coltello per goniotomia



WHEELER  
 EV43218-12  
 12 cm, 4 3/4"



ZIEGLER  
 EV43221-11  
 11 cm, 4 3/8"  
 3,5 mm



TOOK  
 EV43228-12  
 12 cm, 4 3/4"



GILL  
 EV43231-12  
 12 cm, 4 3/4"



ELSCHNIG  
 EV43233-13  
 13 cm, 5 1/8"



PATON  
 EV43245-12  
 12 cm, 4 3/4"



LUNDSGAARD  
 EV43251-12  
 12 cm, 4 3/4"



GUYTON-LUNDSGAARD  
 EV43253-12



BARKAN  
 EV43256-12



SCHEIE  
 EV43258-12



BURCH  
 EV43262-12



PAUFIQUE  
 EV43271-11



BARRAQUER  
 EV43273-13

Diszisionsnadeln, Fremdkörpernadeln, Fremdkörperhohlmeißel  
 Discision Needles, Foreign-Body Instruments  
 Aguja de discisión, Instrumental para cuerpos extraños  
 Aghi per discisione, strumenti per corpi estranei



EV43304-12



EV43305-12



BOWMAN  
EV43308-12



BOWMAN  
EV43309-12



EV43310-13



EV43311-13



LEVINSON  
EV43314-13



FRANCIS  
EV43321-12



DAVIS  
EV43325-13



LA FORCE  
EV43327-12



DIX  
EV43330-13



ELLIS  
EV43331-11



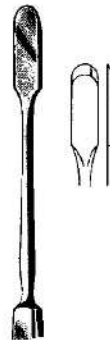
WALTON  
EV43332-12  
1,4 mm



WALTON  
EV43334-12  
1,4 mm



ALVIS  
EV43336-12



GREEN  
EV43340-13



ROLLET  
EV43342-12

Schielhaken, Tenotomiehaken, Extraktionshaken, Tränensackhäkchen  
 Strabismus hook, lens hook, extraction hook  
 Ganchos para estrabismo,- cristalino, extracción  
 Uncino per il strabismo, uncino p. cristallino, protettori, uncini per l'iride



Fig. 1  
 GRAEFE  
 EV43351-01  
 13 cm, 5 1/8"



Fig. 2  
 GRAEFE  
 EV43351-02  
 14 cm, 5 1/2"



Fig. 3  
 GRAEFE  
 EV43351-03  
 15 cm, 6"



JAMESON  
 EV43353-13



GREEN  
 EV43355-13



STEVENS  
 EV43357-13



Fig. 1  
 ARRUGA  
 EV43363-01



Fig. 2  
 ARRUGA  
 EV43363-02



O'CONNER  
 EV43370-12



WIENER  
 EV43372-13



WIENER  
 EV43373-13



ROLLET  
 EV43376-13



KNAPP  
 EV43377-13



GRAEFE  
 EV43380-13



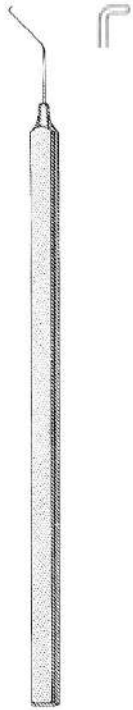
GRAEFE  
 EV43381-13



GRAEFE  
 EV43383-13



BECKER  
 EV43386-13



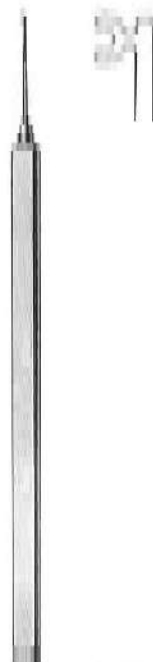
CLAYMAN  
EV43387-02  
11,5 cm 4 1/2"



SINSKEY  
EV43388-02  
11,4 cm 4 1/2"



SINSKEY  
EV43389-02  
12 cm 4 3/4"

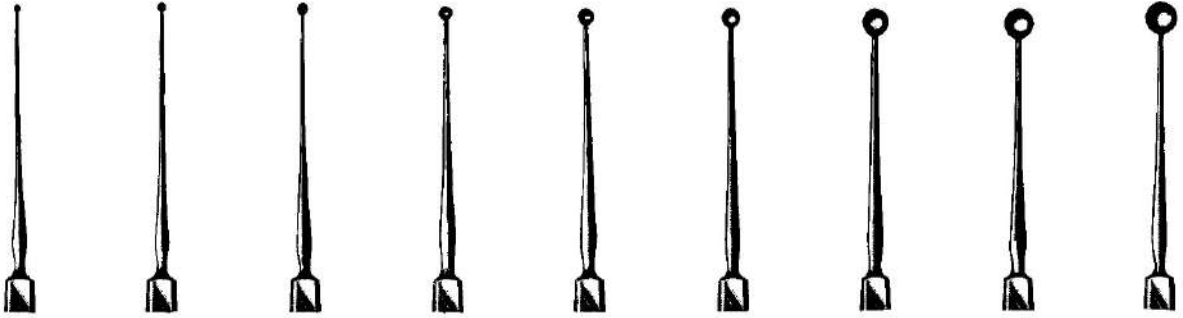


KUGLEN  
EV43390-05  
11,7 cm 4 5/8"



GASS  
EV43391-13  
14,6 cm 5 3/4"

Küretten und Löffel für Chalazion und Star  
 Scoops and Curettes for Chalazio, Cataract, and Exenteration  
 Curetas y cucharillas para chalazión, catarata y exenteración  
 Curette e cucchiari per calazio, cateratta e palpebre



MEYHOEFER

EV43402-05 Ø mm 0,5    EV43402-10 1,0    EV43402-15 1,5    EV43402-18 1,8    EV43402-20 2,0    EV43402-25 2,5    EV43402-35 3,5    EV43402-40 4,0    EV43402-45 4,5



HEBRA EV43404-10 Ø mm 1,0    HEBRA EV43404-20 2,0    HEBRA EV43404-24 2,5    HEBRA EV43404-30 3,0    HEBRA EV43404-35 3,5



AXENFELD  
EV43407-13



GRAEFE  
EV43410-01



GRAEFE  
EV43410-02



DAVIEL  
EV43412-01  
3 mm



DAVIEL  
EV43412-02  
4 mm

Starlöffel, Exenterationslöffel, Drahtschlingen, Starschlingen, Irisspatel, E nukleationslöffel, Wundlöffel  
 Cataract Spoon, Exenteration Scoops, Lens Scoops, Spatulas, Protectores  
 Cucharillas para Catarata-, exenteración, Asas, Espátulas, Protectores  
 Cucchiaio per cateratta- esenterazione, Anse, Spatole, Protettori



KNAPP  
EV43414-02



BUNGE  
EV43420-01



BUNGE  
EV43420-02



BUNGE  
EV43420-03



LANG  
EV43424-13



WEBER  
EV43441-01  
Fig. 1



WEBER  
EV43441-02  
Fig. 2



SNELLEN  
EV43443-13



WILDER  
EV43445-13  
Fig. 1



WILDER  
EV43447-13  
Fig. 2



ARLT



EV43449-01



EV43449-02

Iris  
Iride



WECKER  
EV43461-13



WECKER  
EV43462-13



WELLS  
EV43482-20



ARRUGA  
EV43485-13



WADSWORTH-TODD  
EV43487-14

Cautery  
Cauter  
Cauterio

Zyklodialysespatel, Fremdkörperinstrumente  
 Cyclodialysis Spatula, Foreign Body Instruments  
 Espátulas para ciclodialísis, Instrumentos para cuerpos extraños  
 Spatole per ciclodialisi, Strumenti per corpi estranei



BANGERTER



EV43501-06  
6 mm



EV43501-10  
10 mm



EV43501-12  
12 mm



EV43511-13 -  
EV43517-09



CASTROVIEJO  
EV43511-13  
1,2 x 10 mm



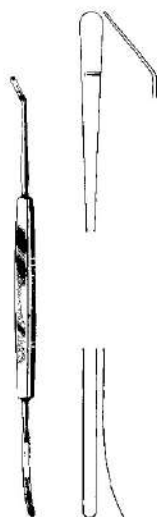
CASTROVIEJO  
EV43513-14  
1,5 x 15 mm



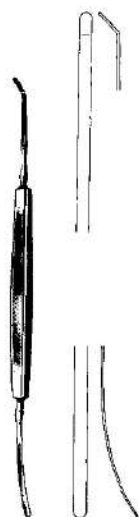
ELSCHNIG  
EV43515-14  
1,2 x 12 mm



CASTROVIEJO  
EV43517-09  
0,8 x 15 mm



CASTROVIEJO  
EV43521-12  
12 cm, 4 3/4"



WHEELER  
EV43523-12  
12 cm, 4 3/4"



HIRSCHMAN  
EV43524-10  
12,5 cm, 5"



CASTROVIEJO  
EV43525-05 0,50 mm  
EV43525-07 0,75 mm  
EV43525-10 1,00 mm



BECHERT  
EV43526-12  
12,5 cm, 5"

Fremdkörperinstrumente, Meßzirkel, Kapselstanze  
 Foreign- Body Instruments, Markers, Corneoscleral punch  
 Instrumental para cuerpos extraños, Compás de la cápsula, Pinza para capsuloiridectom  
 Strumenti per corpi estranei, Marcatori, Pinza per capsula



DIX  
EV43542-12



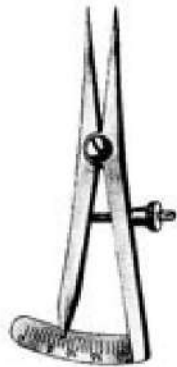
DIX  
EV43544-12



DIX  
EV43546-13



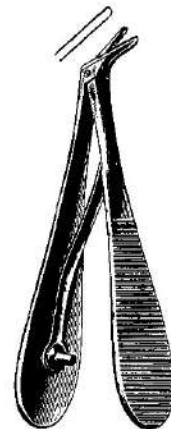
DIX  
EV43548-13



CASTROVIEJO  
EV43583-07 0-20 mm  
7 cm, 2 3/4"



CONNIN-AMSLER  
EV43589-13



HOLTH  
EV43593-09  
9 cm, 3 1/2"





Tränenkanaldilatatoren, Sonden  
 Lachrymal Dilators-, Probes  
 Dilatadores, Estiletos para canal lacrimal  
 Dilatatori e Specilli per canale lacrimale



WILDER  
EV43602-01



WILDER  
EV43602-02



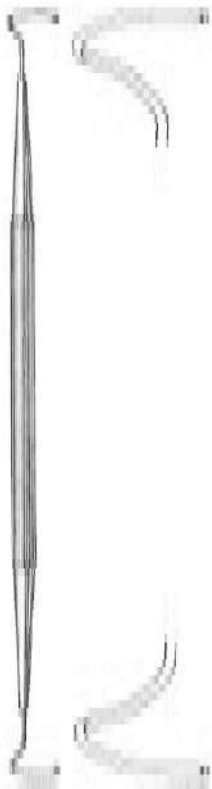
WILDER  
EV43602-03



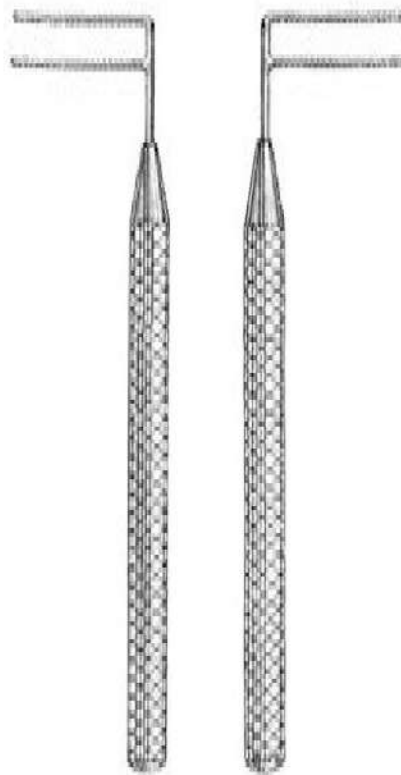
Fig. ZIEGLER  
 1/2 EV43605-12  
 3/4 EV43605-34  
 5/6 EV43605-56



CASTROVIEJO  
EV43608-12



WORST  
EV43609-14  
14,9 cm 5 7/8"



HARMS  
EV43610-01 EV43610-02  
4,8 cm 1 7/8"

geknöpft



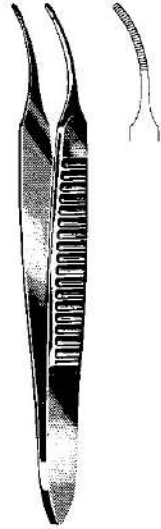
rostfrei  
stainless steel  
acero inoxidable  
acciaio inossidabile

| Fig.     | BOWMAN     | Ø mm    |
|----------|------------|---------|
| 0000/000 | EV43613-00 | 0,6/0,7 |
| 00/0     | EV43614-00 | 0,7/0,8 |
| 0/1      | EV43614-01 | 0,8/0,9 |
| 1/2      | EV43614-12 | 0,9/1,1 |
| 2/3      | EV43614-23 | 1,1/1,3 |
| 3/4      | EV43614-34 | 1,3/1,4 |
| 4/5      | EV43614-45 | 1,4/1,5 |
| 5/6      | EV43614-56 | 1,5/1,6 |
| 6/7      | EV43614-67 | 1,6/1,8 |
| 7/8      | EV43614-78 | 1,8/1,9 |

Iris Pinzetten  
Iris Forceps  
Pinzas para iris  
Pinze per iride



GRAEFE  
EV43802-07  
7 cm (2 3/4")/1 mm



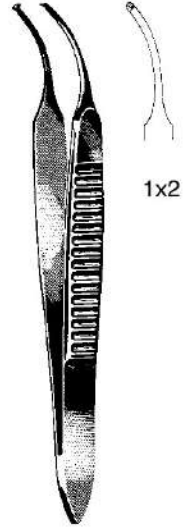
GRAEFE  
EV43803-07  
7 cm (2 3/4")/1 mm



GRAEFE  
EV43804-07  
7 cm (2 3/4")/1 mm



1x2



GRAEFE  
EV43805-07  
7 cm (2 3/4")/1 mm

1x2



GRAEFE  
EV43810-10  
10 cm 4"



GRAEFE  
EV43811-10  
10 cm 4"



GRAEFE  
EV43813-10  
10 cm 4"



GRAEFE  
EV43820-10  
10 cm 4"

1x2



GRAEFE  
EV43821-10  
10 cm 4"

1x2



GRAEFE  
EV43823-10  
10 cm 4"

1x2



STEVENS  
EV43830-10  
10,5 cm, 4.1"



STEVENS  
EV43831-10  
10,5 cm  
4.1"



STEVENS  
EV43833-10  
10,5 cm  
4.1"



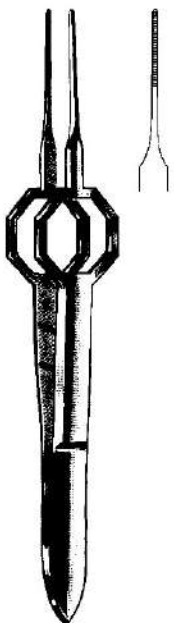
STEVENS  
EV43840-10  
10,5 cm  
4.1"



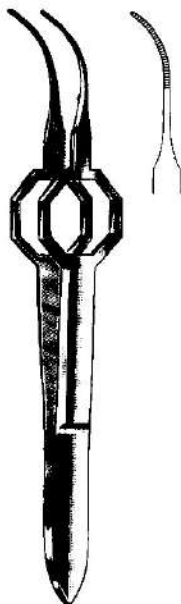
STEVENS  
EV43841-10  
10,5 cm  
4.1"



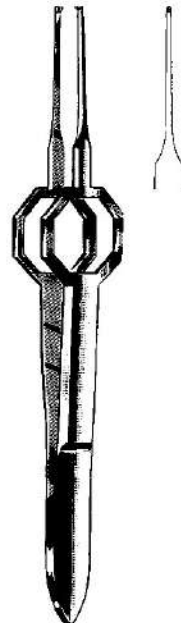
STEVENS  
EV43843-10  
10,5 cm  
4.1"



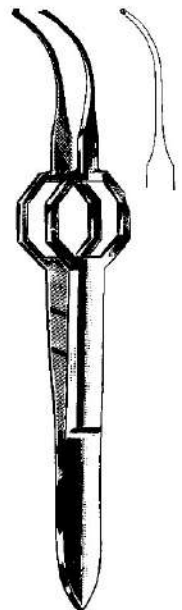
FOERSTER  
EV43850-08  
8,5 cm, 3.4"



FOERSTER  
EV43851-08  
8,5 cm, 3.4"



FOERSTER  
EV43852-08  
8,5 cm, 3.4"



FOERSTER  
EV43853-08  
8,5 cm, 3.4"

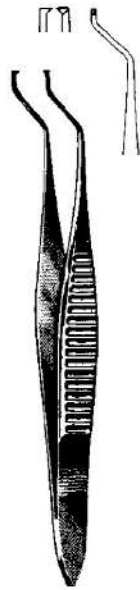
Iris Pinzetten  
Iris Forceps  
Pinzas para iris  
Pinze per iride

seitliche Zähne  
lateral teeth  
dientes laterales  
denti laterali

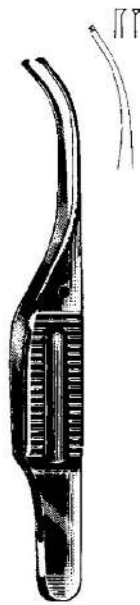
Zähne abwärts  
teeth below  
dientes abajo  
denti in basso



HESS  
EV43855-07  
7 cm (2 3/4")/  
0,3 mm



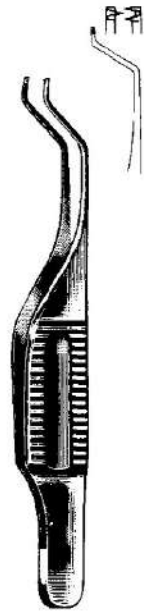
HESS  
EV43857-07  
7 cm (2 3/4")/  
0,3 mm



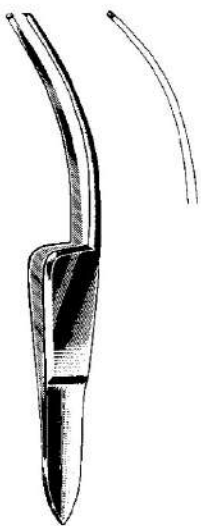
GILL  
EV43861-07  
7,5 cm (3")/  
0,3 mm



GILL-HESS  
EV43863-07  
7,5 cm (3")/  
0,3 mm



GILL-HESS  
EV43865-07  
7,5 cm (3")/  
0,3 mm



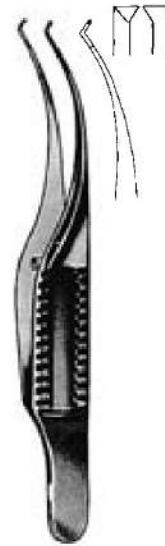
FISCHER  
EV43869-07  
7 cm (2 3/4")



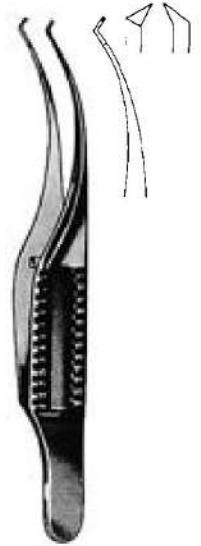
BARRAQUER-KATZIN  
EV43881-07  
7 cm (2 3/4")/0,4 mm



TROUTMAN (Colibri)  
EV43883-07  
7 cm (2 3/4")/0,12 mm

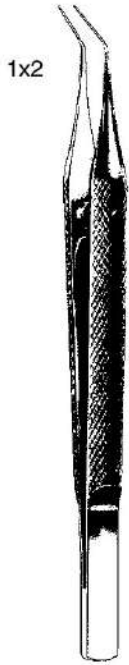


BARRAQUER (Colibri)  
EV43885-07  
7 cm (2 3/4")/0,12 mm



BARRAQUER (Colibri)  
EV43887-07  
7 cm (2 3/4")/0,12 mm

Fixierpinzette, Strabismus-Pinzetten  
 Fixation forceps, Strabismus-Forceps  
 Pinza para fijación, Pinzas para estrabismo  
 Pinza per fissatrice, Pinze per strabismo



1x2

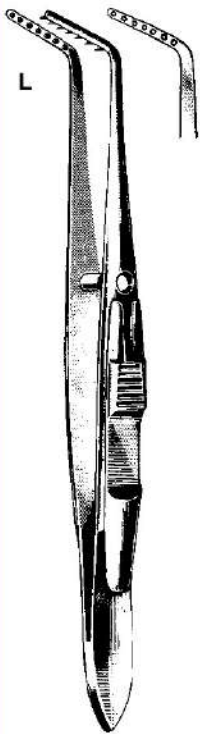
KIRBY-ARTHUR  
 EV43891-09 9 cm, 3  
 $\frac{1}{2}$ " 0,2 mm



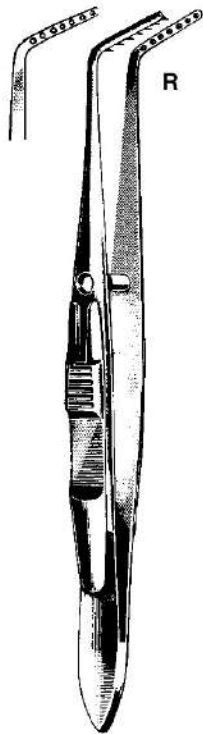
McCULLOUGH  
 EV43902-09  
 9,5 cm, 3  $\frac{3}{4}$ "



McCULLOUGH  
 EV43903-09  
 9,5 cm, 3  $\frac{3}{4}$ "



JAMESON  
 EV43907-10  
 10 cm, 4"



JAMESON  
 EV43909-10  
 10 cm, 4"



BONACCOLTO  
 EV43914-10  
 10 cm, 4  $\frac{1}{16}$ " 7 mm



BONACCOLTO  
 EV43916-10  
 10 cm, 4  $\frac{1}{16}$ " 2 mm

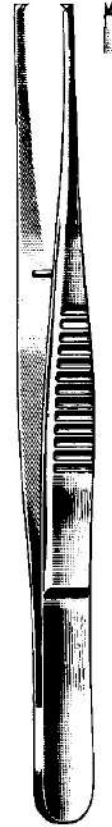


BONACCOLTO  
 EV43920-11  
 11 cm, 4  $\frac{3}{8}$ "

Strabismus-Pinzetten, Iris-Pinzetten  
 Strabismus-Forceps, Iris Forceps  
 Pinzas para estrabismo, Pinzas para iris  
 Pinze per strabismo, Pinze per iride



DASTOOR  
 EV43924-11  
 11 cm, 4 <sup>3</sup>/<sub>8</sub>"



DASTOOR  
 EV43926-11  
 11 cm, 4 <sup>3</sup>/<sub>8</sub>"



BISHOP-HARMAN  
 EV43940-05 8,5 cm,  
 3.4" 0,5 mm



BISHOP-HARMAN  
 EV43940-08 8,5 cm,  
 3.4" 0,8 mm



1x2

BISHOP-HARMAN  
 EV43942-05 8,5 cm,  
 3.4" 0,5 mm



1x2

BISHOP-HARMAN  
 EV43942-08 8,5 cm,  
 3.4" 0,8 mm

Iris Pinzetten, Nahtpinzetten, Muskelpinzetten  
 Iris, Suture forceps, Muscle Forceps  
 Pinzas para iris, Pinza para sutura, Pinzas musculares  
 Pinze per iride, Pinza per sutura, muscolari

mit Führungsstift  
 with guide pin  
 con perno guida  
 con perno di guida

ohne Führungsstift  
 without guide pin  
 sin perno guida  
 senza perno di guida



MOD. BONN  
 EV43944-07  
 7 cm, 2 3/4"  
 0,12 mm



MOD. BONN  
 EV43946-07  
 7 cm, 2 3/4"  
 0,12 mm



MOD. BONN  
 EV43948-10  
 10 cm, 4"  
 0,12 mm



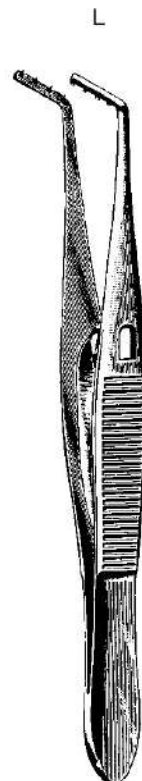
MOD. TÜBINGEN  
 EV43950-10  
 10 cm, 4"



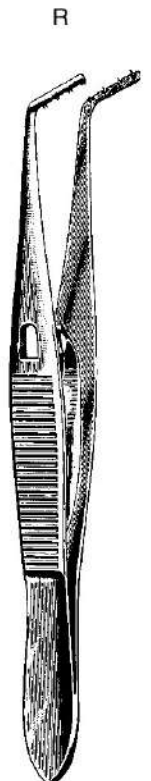
MOD. BONN  
 EV43952-10  
 10 cm, 4"/0,12 mm



MOD. TÜBINGEN  
 EV43953-10  
 10 cm, 4"

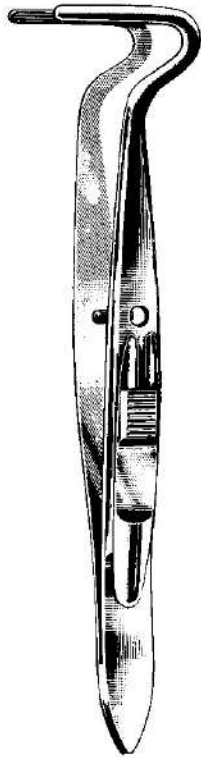


PRINCE  
 EV43955-10  
 10 cm, 4"

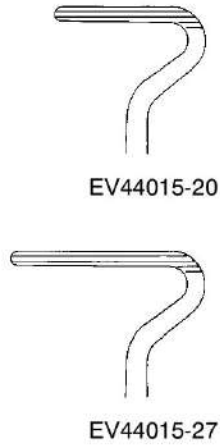


PRINCE  
 EV43956-10  
 10 cm, 4"

Muskelpinzetten, Fixationspinzetten  
 Muscule Forceps, Fixation Forceps  
 Pinzas musculares, Pinzas para fijación  
 Pinze muscolari, Pinze per fissaggio



BERKE  
 EV44015-20 - EV44015-27  
 10 cm, 4"



TROUTMAN  
 EV44017-08 8,5 cm,  
 3.4" 0,8 mm



ELSCHNIG  
 EV44046-11  
 11 cm, 4 3/8"



GRAEFE  
 EV44050-11 - EV44052-11  
 11 cm, 4 3/8"



EV44050-11



EV44052-11  
 mit Sperre  
 with catch  
 con cierre  
 c. cremagliera



LESTER  
 EV44054-09  
 9 cm, 3 1/2"



Fixierpinzetten, Kapselpinzette  
 Fixation forceps, capsular forceps  
 Pinzas para fijación, Pinzas capsulares  
 Pinze fissatrici, Pinze per capsulari

1x1



CASTROVIEJO  
 EV44066-09  
 9 cm, 3 1/2"

1x1



CASTROVIEJO  
 EV44067-09  
 9 cm, 3 1/2"

2x2

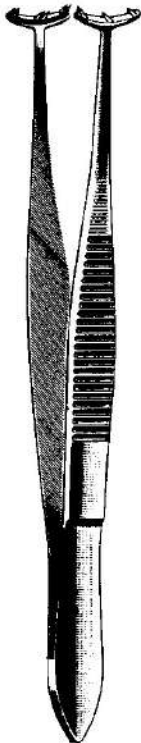


CASTROVIEJO  
 EV44068-09  
 9 cm, 3 1/2"

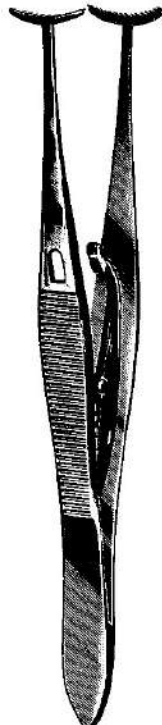
2x2



CASTROVIEJO  
 EV44069-09  
 9 cm, 3 1/2"



BARRAQUER  
 EV44074-10  
 10 cm, 4"



GREEN  
 EV44076-05 - EV44078-10  
 10 cm, 4"



EV44076-05 5 mm  
 EV44076-10 10 mm

ohne Sperre  
 without catch  
 sin cierre  
 senza cremagliera



EV44078-05 5 mm  
 EV44078-10 10 mm

mit Sperre  
 with catch  
 con cierre  
 con cremagliera



GILL-ARRUGA  
 EV44101-07  
 7,5 cm, 3"

Kapselpinzetten  
 Capsular Forceps  
 Pinzas capsulares  
 Pinze capsulare



TERSON  
 EV44103-09 9  
 cm, 3 1/2"



KALT  
 EV44106-10  
 10 cm, 4"



ELSCHNIG  
 EV44109-10  
 10 cm, 4"



ARRUGA  
 EV44111-10  
 10 cm, 4"



ARRUGA  
 EV44114-10  
 10 cm, 4"



CASTROVIEJO  
 EV44115-10  
 10 cm, 4"



SCHWEIGGER  
 EV44117-10  
 10 cm, 4"



SCHWEIGGER  
 EV44119-10  
 10 cm, 4"



ELSCHNIG  
 EV44121-10  
 10 cm, 4"



HESS  
 EV44125-06  
 6 cm, 2.4"



HESS  
 EV44127-06  
 6,5 cm, 2.6"



FUCHS  
 EV44129-07  
 7 cm, 2 3/4"

1x2



CASTROVIEJO  
10 cm, 4"

EV44150-01 0,12 mm  
EV44150-03 0,30 mm  
EV44150-05 0,50 mm  
EV44150-10 1,00 mm  
EV44150-15 1,50 mm

1x2



CASTROVIEJO  
10 cm, 4"

EV44151-05  
EV44151-10  
EV44151-15

Zahn  
tooth  
diente  
dente



MOORFIELD  
EV44164-10  
10 cm, 4"



St. MARTIN  
EV44166-07  
7 cm, 2 3/4"



Mod. TÜBINGEN  
EV44181-10  
10 cm, 4"

1x2



PAUFIQUE  
EV44190-08  
8,5 cm, 3.4"



PAUFIQUE  
EV44202-08  
8,5 cm, 3.4"



McPHERSON  
EV44210-10  
10 cm, 4"



McPHERSON  
EV44220-10  
10 cm, 4"

Pinzetten für Chalazion und Trachom  
 Forceps for Chalazion and Trachoma  
 Pinzas de chalazión y para tracoma  
 Pinze per calazio e per trichiasi



AYER  
 EV44240-09  
 9 cm, 3 1/2"



AYER  
 EV44242-09  
 9 cm, 3 1/2"



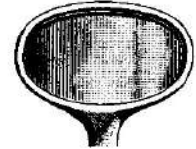
LAMBERT  
 EV44246-09  
 9 cm, 3 1/2"



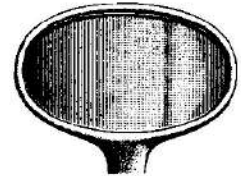
DESMARRES  
 EV44254-09 - EV44258-09  
 9 cm, 3 1/2"



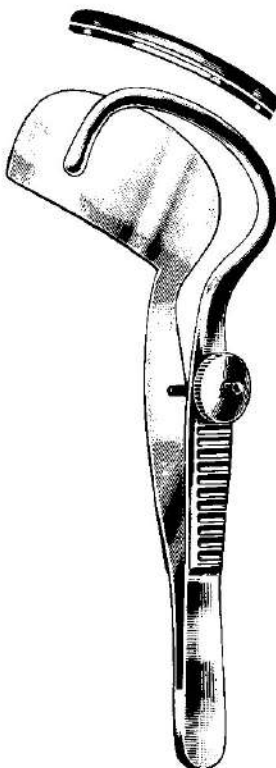
EV44254-09  
 20 mm Fig. 1



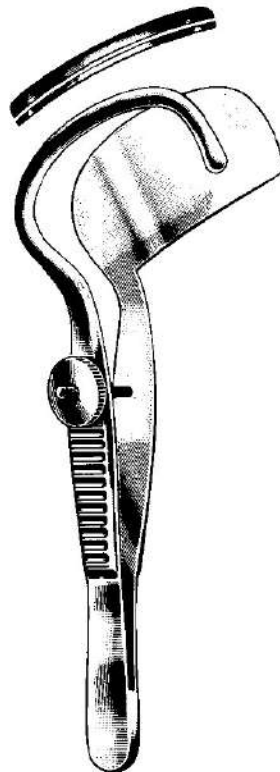
EV44256-09  
 24 mm Fig. 2



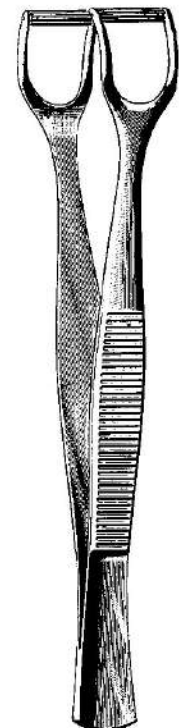
EV44258-09  
 32 mm Fig. 3



SNELLEN  
 EV44265-10 10 cm, 4"



SNELLEN  
 EV44267-10 10 cm, 4"



KNAPP-LUER  
 EV44274-11 11 cm, 4 3/8"

Augenkanülen  
 Eye Cannulas  
 Cánulas oculares  
 Cannule oculistiche



LACRIMAL  
 EV44300-00 23 gauge



LACRIMAL  
 EV44301-00 23 gauge



McIntyre EV44310-00  
 23 gauge



McIntyre EV44311-00  
 23 gauge



Air Injection  
 EV44320-00 27 gauge  
 EV44330-00 30 gauge



JENSEN  
 EV44340-00 23 gauge  
 EV44350-00 25 gauge

Spül- und Saugkanülen, Augenkanülen  
Irrigation and Aspiration Cannulas, Eye Cannulas  
Cánulas de irrigación y aspiración, Cánulas oculares  
Cannule per irrigazione ed aspirazione, Cannule oculistiche



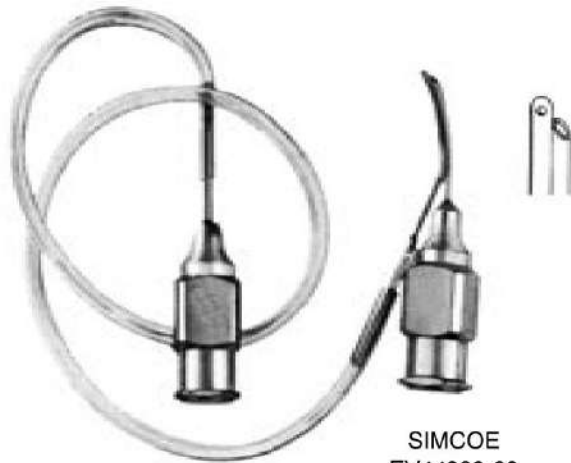
**BISHOP-HARMON**

- EV44370-00 komplett / complete
- EV44371-00 Silikonball / silicone bulb
- EV44372-00 Adapter / adaptor
- EV44373-00 19 gauge Kanüle / cannula
- EV44374-00 21 gauge Kanüle / cannula

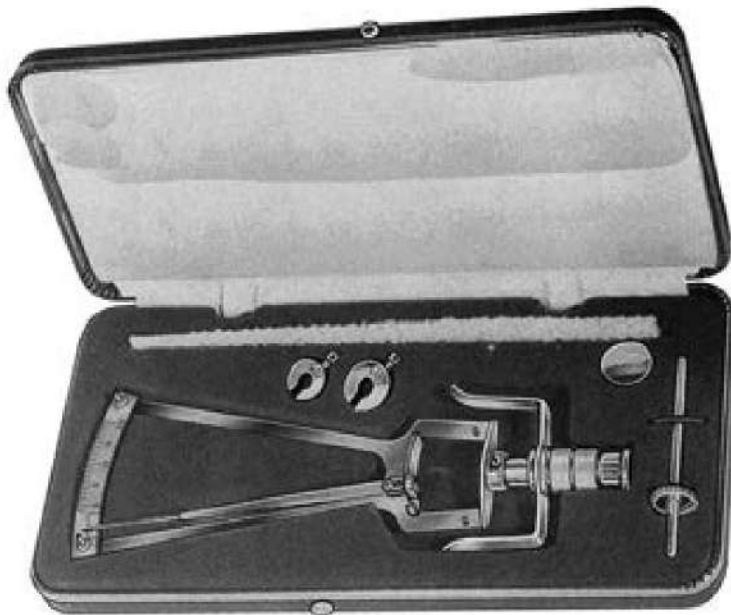
Augenkanülen, Tonometer  
 Eye Cannulas, Tonometer  
 Cánulas oculares, Tonómetro  
 Cannule oculistiche, Tonometro



SHEETS  
 EV44380-00



SIMCOE  
 EV44390-00



SCHIOETZ  
 EV44404-00 EV44406-00  
 Skala gerade schräg  
 scale straight oblique  
 escala recta oblicua  
 scala retta obliqua

EV44404-00 G geeicht  
 EV44406-00 G calibrated  
 calibrado  
 calibrato

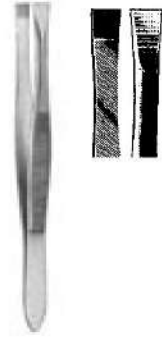
Augenmagnet, Cilienpinzetten  
 Eye Magnet, Cilia Forceps  
 Imàn para cuerpos extraños, Pinzas depilatorias  
 Calamita per corpi estranei, Pinze depilatorie



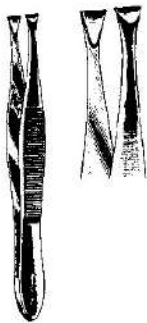
ELGEN  
 EV44408-00



BEER  
 EV44420-09  
 9 cm, 3 1/2"



DOUGLAS  
 EV44422-09  
 9 cm, 3 1/2"



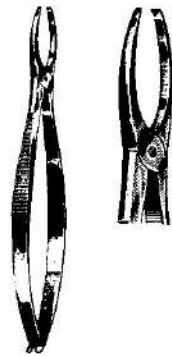
LITTAUER  
 EV44424-08  
 8,5 cm, 3.4"



BARRAQUER  
 EV44425-10  
 10,5 cm, 4.1"



ELGEN  
 EV44426-09  
 9 cm, 3 1/2"



GRADLE  
 EV44428-09 9,5  
 cm, 3 3/4"



Ohrspekula  
Ear Specula  
Espéculos auriculares  
Specoli auricolari

GERNAL SURGICAL



POLITZER  
EV45009-00  
Set = 3

Innen Ø  
○ = 2,0 mm  
EV45009-02

○ = 3,0 mm  
EV45009-03

○ = 4,0 mm  
EV45009-04



HARTMANN  
EV45010-00  
Set = 4

Innen Ø  
○ = 2,0 mm  
EV45010-20

○ = 3,0 mm  
EV45010-30

○ = 4,5 mm  
EV45010-45

○ = 5,5 mm  
EV45010-55

○ = 6,5 mm  
EV45010-65

○ = 7,5 mm  
EV45010-75



HARTMANN  
EV45011-00  
Set 3-7 mm

schwarz  
black  
negro  
nero

Innen Ø  
○ = 2,0 mm  
EV45011-03

○ = 3,5 mm  
EV45011-04

○ = 5,0 mm  
EV45011-05

○ = 6,5 mm  
EV45011-07

○ = 7,5 mm  
EV45011-08



TOYNBEE  
EV45012-00  
Set = 3

Innen Ø  
○ = 4,0 mm  
EV45012-40

○ = 5,5 mm  
EV45012-55

○ = 6,5 mm  
EV45012-65

○ = 7,5 mm  
EV45012-75



GRUBER, rund  
EV45014-00  
Set = 4

Innen Ø  
○ = 4,5 mm  
EV45014-45

○ = 5,5 mm  
EV45014-55

○ = 6,5 mm  
EV45014-65

○ = 7,5 mm  
EV45014-75

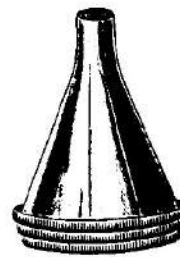


GRUBER, oval  
EV45015-00  
Set = 3

Innen Ø  
○ = 4,5 mm  
EV45015-45

○ = 5,5 mm  
EV45015-55

○ = 6,5 mm  
EV45015-65



BOUCHERON  
EV45018-00  
Set = 4

Innen Ø  
○ = 5,0 mm  
EV45018-50

○ = 6,0 mm  
EV45018-60

○ = 7,0 mm  
EV45018-70

○ = 8,0 mm  
EV45018-80

Ohrspekula  
Ear Specula  
Espéculos auriculares  
Specoli auricolari



EV45020-01  
Ø 3 mm



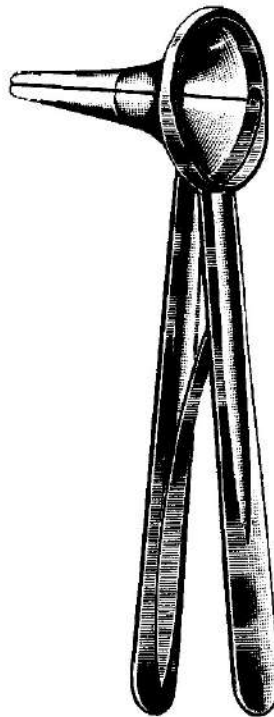
EV45020-02  
Ø 4 mm



EV45020-03  
Ø 5 mm



EV45020-04  
Ø 6 mm



RICHNAU-HOLMGREN

6,5 mm



EV45030-06

7,5 mm



EV45030-07

8,2 mm

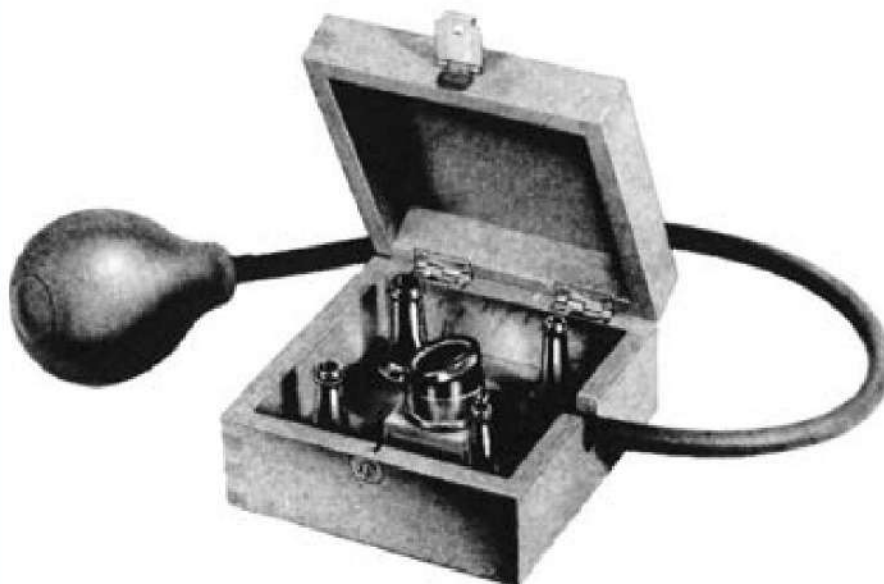


EV45030-08

10 mm



EV45030-10



BRUENINGS  
EV45030-04

**EV45030-04**

Komplett bestehend aus:  
4 Spekula, Saugkammer mit  
Gebläse, Holzetui

Complete consisting of:  
4 specula, suction head and rubber  
tube with bulb, wooden case

Compuesto de:  
4 espéculos, cámara de aspiración,  
insuflador de goma, en estuche de  
madera

Composta da:  
4 specoli, camera aspirante con  
soffiatrice, scatola di legno

Ersatzteile / spare parts /  
repuestos / pezzi di ricambio

**EV45036-09**

Lupe / Magnification glass /  
lupa / lente d'ingrandimento

**EV45036-10**

Saugpumpe / rubber ball /  
pera de goma / soffiatrice di gomma

Ohrspekula  
Ear Specula  
Espéculos auriculares  
Specoli auricolari



6,5 mm Ø



EV45036-06



7 mm Ø



EV45036-07



8 mm Ø



EV45036-08



SIEGLE  
EV45036-03

**EV45036-03**

Komplett bestehend aus:  
Ohrspekulum, 3 Spekula, 1 Gebläse

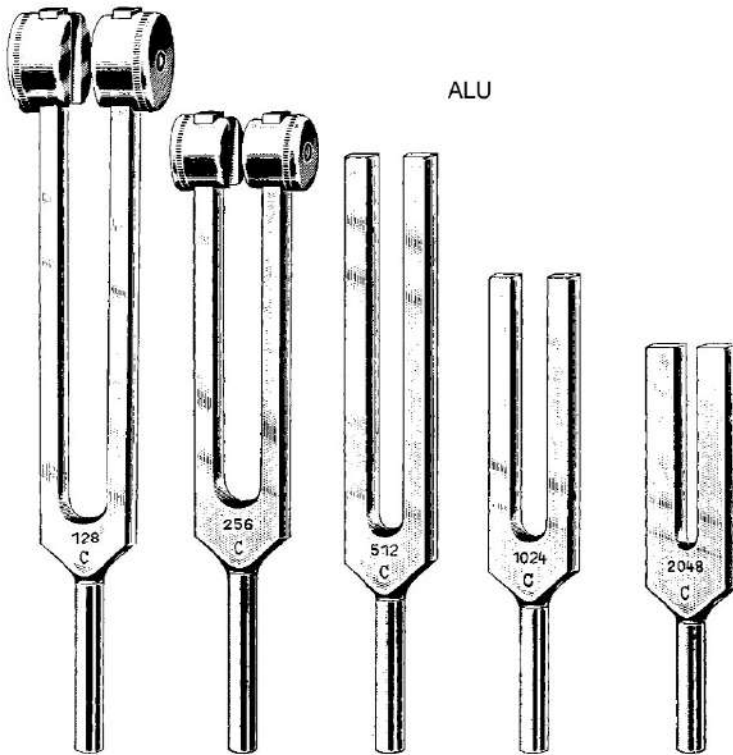
Complete consisting of:  
Ear Specula, 1 rubber tube with bulb

Compuesto de:  
Otoscopio con 3 espéculos, insuflador y tubo

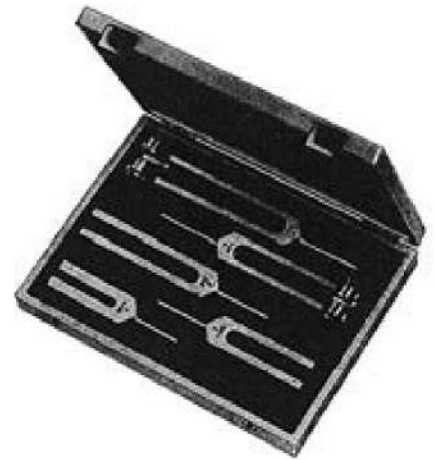
Composta da:  
Otoscopio con 3 specoli e 1 insufflatore con tubo

Stimmgabeln  
Tuning Forks  
Diapasones  
Diapason

ALU

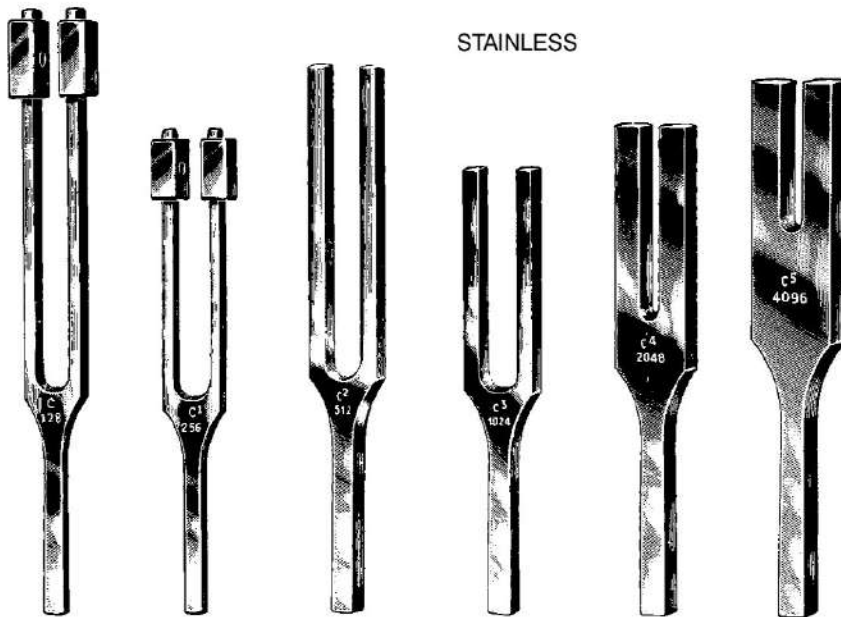


EV45060-01 C 128    EV45060-02 C<sup>1</sup> 256    EV45060-03 C<sup>2</sup> 512    EV45060-04 C<sup>3</sup> 1024    EV45060-05 C<sup>4</sup> 2048

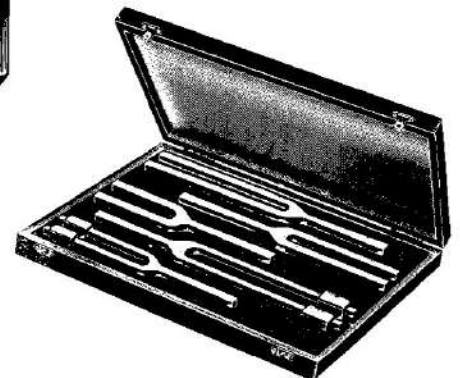


EV45061-00 compl.

STAINLESS

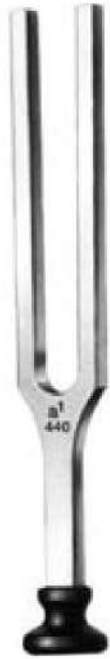


EV45070-01 C 128    EV45070-02 C<sup>1</sup> 256    EV45070-03 C<sup>2</sup> 512    EV45070-04 C<sup>3</sup> 1024    EV45070-05 C<sup>4</sup> 2048    EV45070-06 C<sup>5</sup> 4096



HARTMANN  
EV45071-00 compl.

Stimmgabeln  
Tuning Forks  
Diapasones  
Diapason



EV45072-01  
a<sup>1</sup> 440



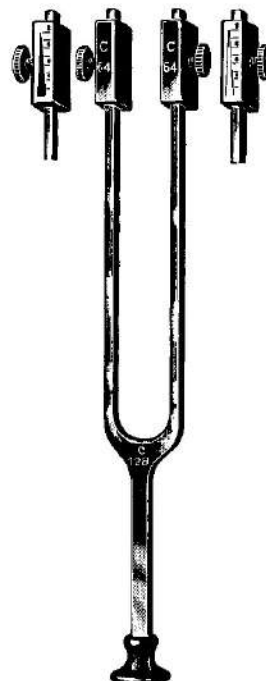
LUCAE  
EV45073-01 C 128  
EV45073-02 C<sup>1</sup> 256  
EV45073-03 C<sup>2</sup> 512  
EV45073-04 C<sup>3</sup> 1024  
EV45073-05 C<sup>4</sup> 2048  
EV45073-06 C<sup>5</sup> 4096



LUCAE  
EV45074-01  
C 128



EV45075-00

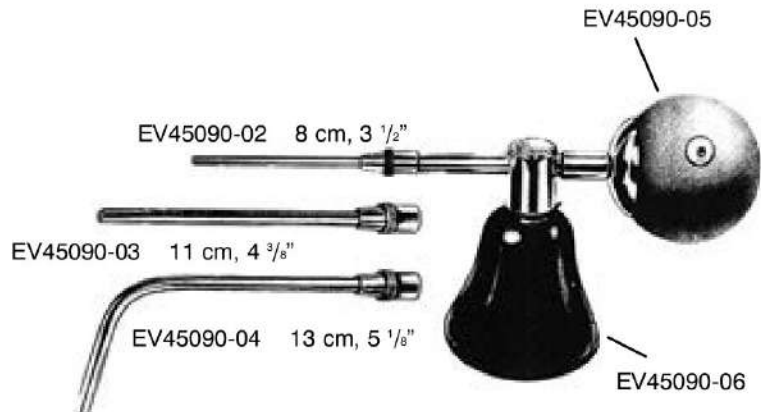


RYDEL-SEIFFERT  
EV45076-01 C 128 / C 64

Lärmtrommel, Pulverbläser  
 Noise Apparatus, Powder Blowers  
 Ensordecedor, Lanzapolvero  
 Assorditore, Insoffiatori per polvere

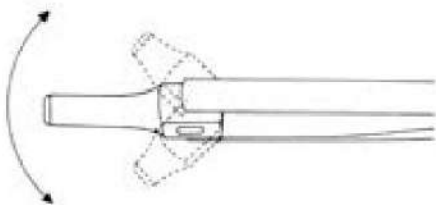


BARANY  
 EV45080-00



KABIERSKE  
 EV45090-00 30 ccm

komplett mit 3 Kanülen und Gummiball  
 complete with 3 cannulas and rubber bulb  
 completo con 3 cánulas y pera de goma  
 completo con 3 cannule e pera di gomma



UNIVERSAL  
 EV45090-08

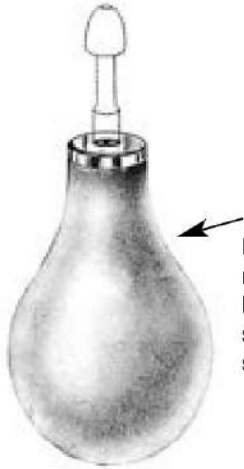
Komplett mit beweglicher Düse,  
 Schraubflasche 30 ccm und Halbgebläse  
 complete with movable tube, screw bottle  
 30 ccm and rubber bulb

completo con tubo móvil botella con rosca  
 30 ccm y pera de goma

completo con tubo mobile, bottiglia con  
 filettatura 30 ccm e pera di insufflazione



Luftdusche, Ohrspritze  
 Air Bag, Ear Syringe  
 Insuflador de aire, Jeringa  
 Insoffiatore d'aria, Siringa Auricolare



EV45091-02 Gum-  
 mibirne alleine Rubber  
 bulb only Pera de goma,  
 sola Pera di gomma,  
 sola



EV45091-03



EV45091-04



EV45091-15

4 mm Ø 15 mm Ø



EV45091-17

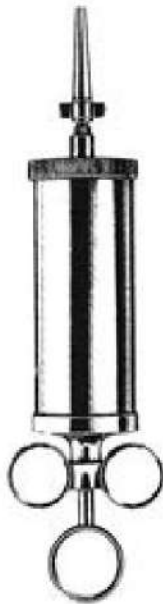


EV45091-22

17 mm Ø 22 mm Ø

POLITZER  
 EV45091-00  
 Set incl.  
 EV45091-03  
 EV45091-15  
 EV45091-17  
 EV45091-22

POLITZER  
 EV45091-01  
 Set incl.  
 EV45091-03  
 EV45091-04  
 EV45091-15  
 EV45091-17  
 EV45091-22



ml REINER 50  
 EV45096-50 75  
 EV45096-75 100  
 EV45097-10 150  
 EV45097-15



EV45097-01



EV45097-02



EV45097-03



Spritze, Küretten  
 Syringe, Curettes  
 Jeringa, Curetas  
 Siringa, Curette



EV45098-01 1 ml  
 EV45098-02 2 ml  
 EV45098-05 5 ml  
 EV45098-10 10 ml  
 EV45098-20 20 ml  
 EV45098-50 50 ml

EV45099-01 1 ml  
 EV45099-02 2 ml  
 EV45099-05 5 ml  
 EV45099-10 10 ml  
 EV45099-20 20 ml  
 EV45099-50 50 ml

Innen Ø 1.5 mm 1.9 mm 2.5 mm 2.7 mm 3.4 mm 4.0 mm 4.5 mm

Küretten  
 Curettes  
 Curetas  
 Curette



Fig. 00 0 1 2 3 4 5

stumpf  
 blunt  
 romas  
 smusse



EV45109-00 EV45110-00 EV45110-01 EV45110-02 EV45110-03 EV45110-04 EV45110-05

scharf  
 sharp  
 cortantes  
 taglianti



EV45111-00 EV45112-00 EV45112-01 EV45112-02 EV45112-03 EV45112-04 EV45112-05

stumpf  
 blunt  
 romas  
 smusse



EV45114-00 EV45115-00 EV45115-01 EV45115-02 EV45115-03 EV45115-04 EV45115-05

scharf  
 sharp  
 cortantes  
 taglianti



EV45116-00 EV45117-00 EV45117-01 EV45117-02 EV45117-03 EV45117-04 EV45117-05

BUCK

14,5 cm, 5 3/4"

Ohrkatheter, Parazentese Nadeln, Ohrmesser  
 Catheters, Paracentesis Needles, Ear Knives  
 Cateteres, agujas para paracentesis, Cuchillos auriculares  
 Cateteri, Aghi per paracentesi, Coltelli auricolari

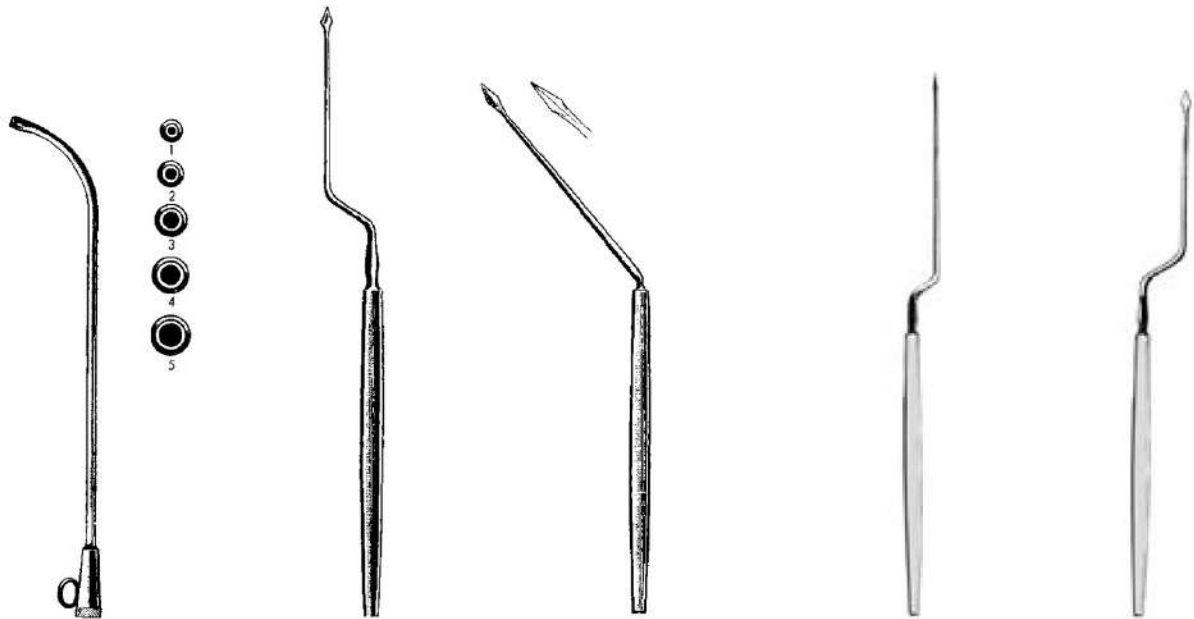


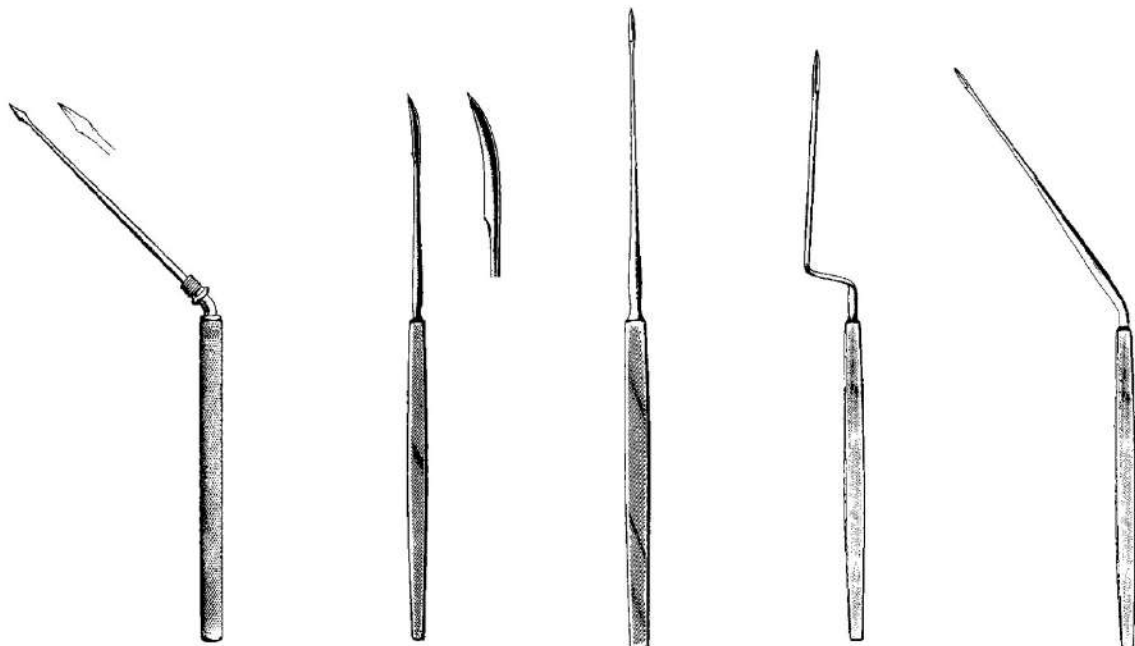
Fig. HARTMANN  
 1 EV45133-01 3,5 mm 2  
 EV45133-02 4,0 mm 3  
 EV45133-03 4,5 mm 4  
 EV45133-04 5,0 mm 5  
 EV45133-05 6,0 mm

POLITZER  
 EV45150-18  
 18 cm, 7"

POLITZER  
 EV45151-16  
 16,5 cm, 6 1/2"

LUCAE  
 EV45152-01  
 18 cm, 7"

LUCAE  
 EV45152-02  
 18 cm, 7"



POLITZER  
 EV45153-16  
 16 cm, 6 1/4"

POLITZER  
 EV45160-15  
 15 cm, 6"

SEXTON  
 EV45162-18  
 18 cm, 7"

SEXTON  
 EV45164-17  
 17 cm, 6 3/4"

SEXTON  
 EV45165-17  
 17 cm, 6 3/4"

Löffel, Schlingen, Haken  
 Ear spoons, Loops, Hooklets  
 Cucharas, Asas, Ganchitos  
 Cucchiali, Anse, Uncinetti

GERNAL SURGICAL



GROSS  
 EV45171-12  
 12 cm, 4 3/4"



BILLEAU  
 16 cm, 6 1/4"



EV45180-01



EV45180-02



EV45180-03



LANGENBECK  
 EV45181-13  
 13 cm, 5 1/8"



ZAUFAL  
 EV45184-16  
 16 cm, 6 1/4"



ZAUFAL-JANSEN  
 EV45185-15  
 15 cm, 6"



DAY  
 16 cm, 6 1/4"



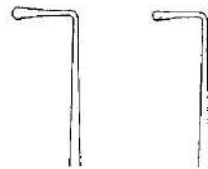
EV45190-01



EV45190-02



WAGENER  
 14 cm, 5 1/2"



EV45192-01



EV45192-02



EV45192-03



EV45192-04



EV45192-05



EV45192-06



EV45193-01  
 2 mm



EV45193-02  
 3 mm

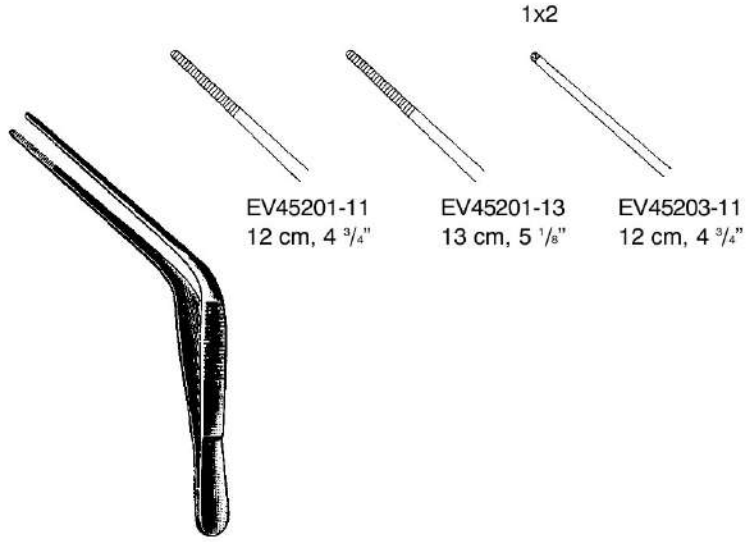
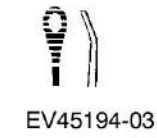


EV45193-03  
 4 mm



LUCAE  
 14 cm, 5 1/2"

Schlingen, Pinzetten  
 Loops, Dressing Forceps  
 Asas, Pinzas  
 Anse, Pinze



SHAPLEIGH  
13 cm, 5 1/8"

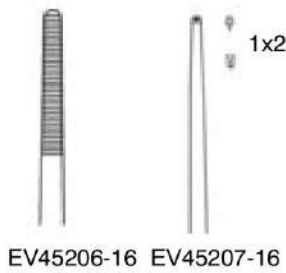
WILDE (TROELTSCH)



LUCAE  
EV45206-14  
14 cm, 5 1/2"



LUCAE  
EV45207-16  
16 cm, 6 1/4"

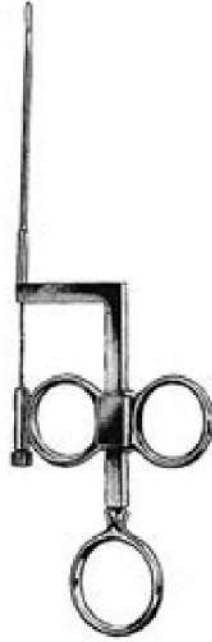


COTTLE  
EV45208-14  
14 cm, 5 1/2"

Polypenschnürer, Ohrzängchen  
 Snares, Ear Forceps  
 Cierra-nudos, Pinzas auriculares  
 Serranodi, Pinze auricolari



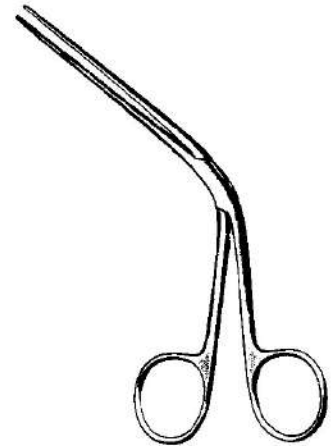
KRAUSE  
 EV45220-16  
 16 cm, 6 1/4"



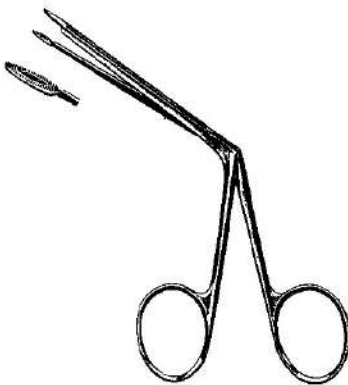
WILDE  
 EV45222-17  
 17 cm, 6 3/4"



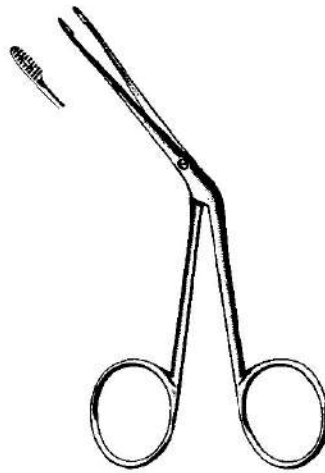
EV45225-02  
 doz./doc./dozz.  
 0,2 mm



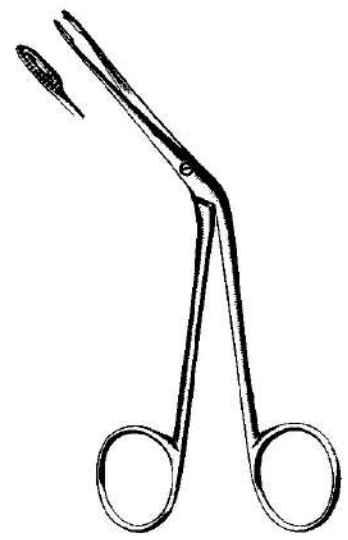
TILLEY  
 EV45243-14  
 14 cm, 5 1/2"



LITTAUER  
 EV45245-12  
 12 cm, 4 3/4"



HARTMANN  
 EV45246-12  
 12 cm, 4 3/4"

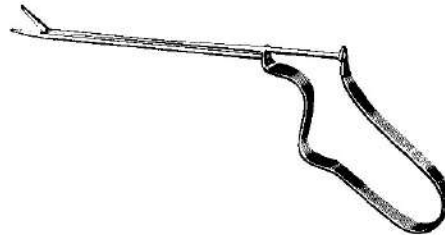


HARTMANN  
 EV45246-14  
 14 cm, 5 1/2"

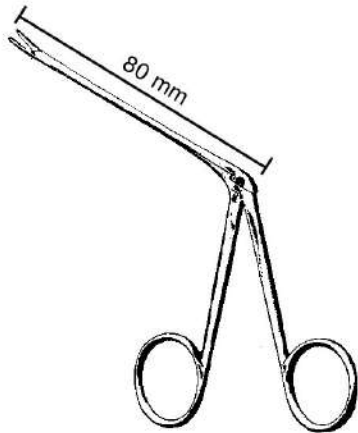
Fremdkörperheber, Fremdkörperzängchen  
 Foreign Body Levers, Ear Polypus Forceps  
 Elevadores para cuerpos extraños, Pinzas para pólipos  
 Leve per corpi estranei, Pinze per polipi



QUIRE  
 EV45251-10  
 10 cm, 4"



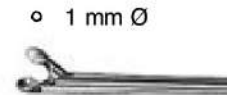
BUCK  
 EV45253-11  
 11 cm, 4 3/8"



EV45255-08 - EV45275-08



HARTMANN-WULLSTEIN  
 EV45255-08 8,5 cm,  
 3.4"



HARTMANN-WULLSTEIN  
 EV45257-08  
 8,5 cm, 3.4"



HARTMANN  
 EV45261-08 8,5 cm, 3.4"  
 EV45261-14 14,0 cm, 5 1/2"  
 EV45261-16 16,0 cm, 6 1/4"



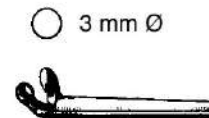
HARTMANN  
 EV45263-08 8,5 cm, 3.4"  
 EV45263-14 14,0 cm, 5 1/2"



HARTMANN  
 EV45265-08  
 8,5 cm, 3.4"



Ø mm HARTMANN  
 2,0 EV45267-20 8,5 cm, 3.4"  
 2,5 EV45267-25 8,5 cm, 3.4"  
 3,0 EV45267-30 8,5 cm, 3.4"



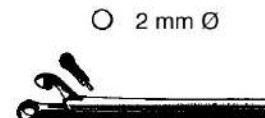
HARTMANN  
 EV45269-30  
 8,5 cm, 3.4"



STRUEMPEL  
 EV45271-08 8,5 cm,  
 3.4" 2,5x5 mm

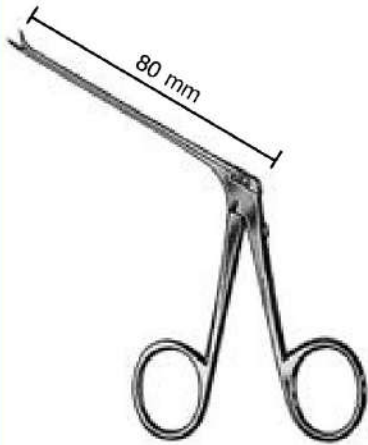


HARTMANN  
 EV45273-08  
 8,5 cm, 3.4"



HARTMANN-HOFFMANN  
 EV45275-08 8,5 cm,  
 3.4"

Mikro-Ohrscheren, Mikro-Ohrzängchen  
 Micro Ear Scissors, Micro Ear Forceps  
 Tijeras auriculares micro, Pinzas auriculares micro  
 Forbici auricolari micro, Pinze auricolari micro



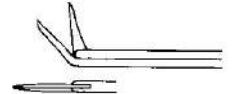
EV45310-40 - EV45322-70



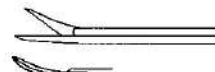
**A**  
 BELLUCCI  
 EV45310-40  
 micro mini  
 4 mm



**A**  
 BELLUCCI  
 EV45312-55  
 micro standard  
 5,5 mm



**D**  
 BELLUCCI  
 EV45313-55  
 micro standard  
 5,5 mm



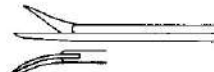
**B**  
 BELLUCCI  
 EV45315-55  
 micro standard  
 5,5 mm



**C**  
 BELLUCCI  
 EV45317-55  
 micro standard  
 5,5 mm



**A**  
 SHEA  
 EV45320-70  
 7,0 mm



**C**  
 SHEA  
 EV45321-70  
 7,0 mm

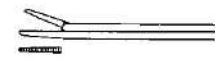


**B**  
 SHEA  
 EV45322-70  
 7,0 mm

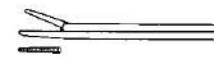
- A:** gerade / straight / recta / retta  
**B:** rechts / right / derecha / destra  
**C:** links / left / izquierda / sinistra  
**D:** aufgebogen / curved up / curva in alto / curva hacia arriba  
**E:** nach unten gebogen / curved down / curva in basso / curva hacia abajo



EV45350-40 - EV45360-35



**A**  
 EV45350-40  
 4 mm



**A**  
 EV45350-70  
 7 mm



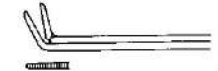
**A**  
 EV45352-40  
 4 mm



**C**  
 EV45353-60  
 6 mm



**B**  
 EV45355-60  
 6 mm



**D**  
 EV45357-40  
 4 mm



**E**  
 EV45359-40  
 4 mm



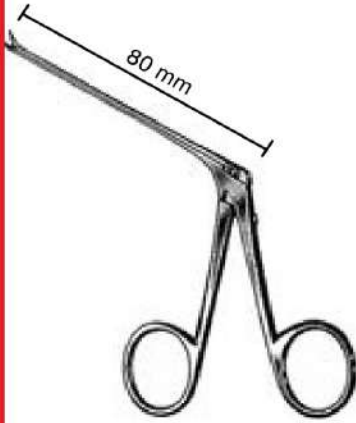
**A**  
 EV45360-35  
 3,5 mm

Mikro-Ohrzängchen, Hammerkopfstanze

Micro Ear Forceps, Malleus punch

Pinzas auriculares micro, Pinza saca-bocadas para cabeza de martillo

Pinze auricolari micro, Pinze taglianti per testa del martelletto taglio a scalpello



EV45362-45 - EV45383-30



**A**  
EV45362-45  
4,5 mm



**C**  
EV45363-45  
4,5 mm



**B**  
EV45365-45  
4,5 mm



**D**  
EV45367-50  
5,0 mm



**E**  
EV45369-50  
5,0 mm



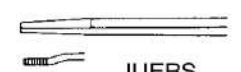
**A**  
GREVEN  
EV45370-50  
5,0 mm



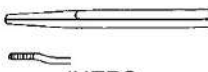
McGEE  
EV45371-40  
0,8x4,0 mm



COS  
EV45373-30  
1,8x0,8x3,0 mm



JUERS  
EV45375-60  
6,0 mm



JUERS  
EV45377-60  
6,0 mm



**C**  
HAUGH  
EV45381-30  
45° 3 mm



**B**  
HAUGH  
EV45383-30  
45° 3 mm

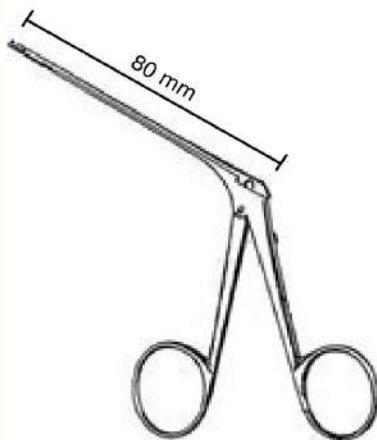
**A:** gerade / straight / recta / retta

**B:** rechts / right / derecha / destra

**C:** links / left / izquierda / sinistra

**D:** aufgebogen / curved up / curva in alto / curva hacia arriba

**E:** nach unten gebogen / curved down / curva in basso / curva hacia abajo



DIETER EV45385-01 -  
EV45387-02

micro ø 1,3 mm



EV45385-01

aufwärts  
upward  
arriba  
in alto

mini ø 1,8 mm



EV45387-01



EV45385-02

abwärts  
downward  
abajo  
in basso



EV45387-02





EV45390-35  
0,8 x 3,5 mm



EV45390-50 1  
x 5 mm



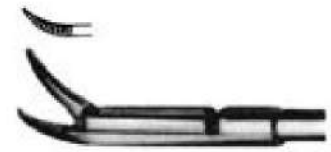
EV45391-35  
0,8 x 3,5 mm



EV45392-35  
0,8 x 3,5 mm



EV45393-50  
1 x 5 mm



EV45394-50  
1 x 5 mm

Mikro-Ohrzängchen  
 Micro Ear Forceps  
 Pinzas auriculares micro  
 Pinze auricolari micro



WULLSTEIN



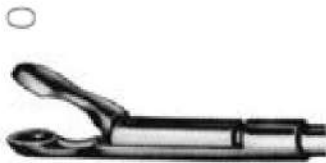
EV45400-01  
 0,9 x 1 mm



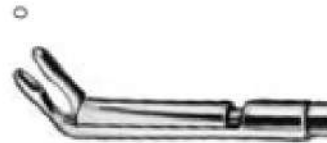
EV45400-02  
 0,8 x 1,3 mm



EV45400-03  
 1 mm



EV45401-25  
 1,7 x 2,5 mm



EV45402-10  
 0,9 x 1 mm



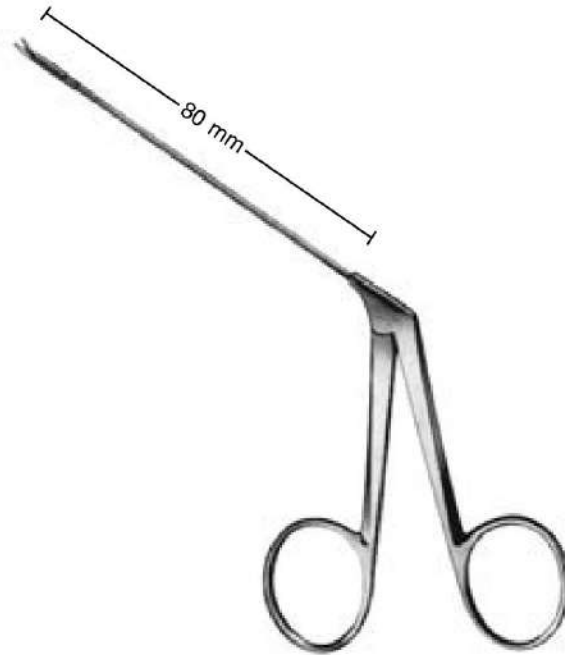
EV45403-13  
 0,8 x 1,3 mm



EV45404-13  
 0,8 x 1,3 mm



Mikro-Ohrscheren  
Micro Ear Scissors  
Tijeras auriculares micro  
Forbici auricolari micro



WULLSTEIN



EV45410-01



EV45411-01



EV45412-01



EV45413-01



EV45414-01

Messer  
Knives  
Cuchillos  
Coltelli



SCHUKNECHT  
EV45701-01  
16 cm, 6 1/4"



SCHUKNECHT  
EV45701-02  
16 cm, 6 1/4"



SCHUKNECHT  
EV45703-15  
15,5 cm, 6"



WULLSTEIN  
EV45704-15  
15,5 cm, 6"



TABB  
EV45705-15  
15,5 cm, 6"



PLESTER  
EV45706-35  
15,5 cm, 6"



EV45709-10  
Ø 1,0 mm



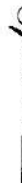
EV45709-14  
Ø 1,4 mm



EV45709-16  
Ø 1,6 mm



EV45709-20  
Ø 2,0 mm



EV45709-26  
Ø 2,6 mm



EV45709-28  
Ø 2,8 mm



EV45709-30 Ø  
3,0 mm



ROSEN  
EV45709-10 - EV45709-30  
16 cm, 6 1/4"



16 cm  
 6 1/4"



BARBARA  
 EV45710-15



BARBARA  
 EV45711-15



BARBARA  
 EV45713-15



BARBARA  
 EV45715-17



25°  
 SHAMBAUGH  
 mm 0,3 EV45720-03  
 0,6 EV45720-06  
 1,0 EV45720-10



45°  
 SHAMBAUGH  
 mm 0,3 EV45722-03  
 0,6 EV45722-06  
 1,0 EV45722-10  
 1,2 EV45722-12  
 1,5 EV45722-15  
 2,0 EV45722-20  
 2,5 EV45722-25



90°  
 SHAMBAUGH  
 mm 0,3 EV45724-03  
 0,6 EV45724-06  
 1,0 EV45724-10  
 1,2 EV45724-12  
 1,5 EV45724-15  
 2,0 EV45724-20  
 2,5 EV45724-25



BARBARA  
 EV45725-05=0,5 mm  
 EV45725-10=1,0 mm



EV45730-03 -  
 EV45747-10 15,5 cm, 6"



90°  
 mm 0,3 EV45730-03  
 0,6 EV45730-06  
 1,0 EV45730-10



90°  
 mm 0,3 EV45732-03  
 0,6 EV45732-06  
 1,0 EV45732-10



mm 0,5  
 1,0

McGEE  
 EV45733-05  
 EV45733-10



McGEE  
 EV45735-05  
 EV45735-10



BARBARA  
 EV45736-15  
 15,5 cm, 6"



ROSEN  
 mm 15,5 cm, 6"



mm 0,3  
 0,6  
 1,0



25°  
 EV45741-03  
 EV45741-06  
 EV45741-10



25°  
 EV45743-03  
 EV45743-06  
 EV45743-10

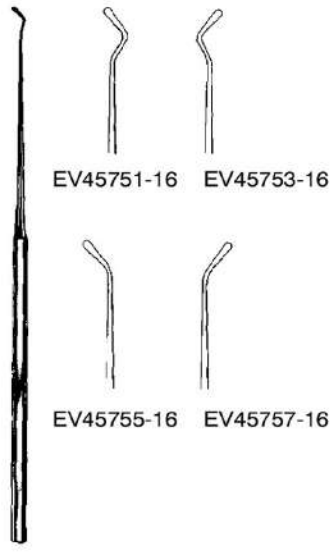


45°  
 EV45745-03  
 EV45745-06  
 EV45745-10



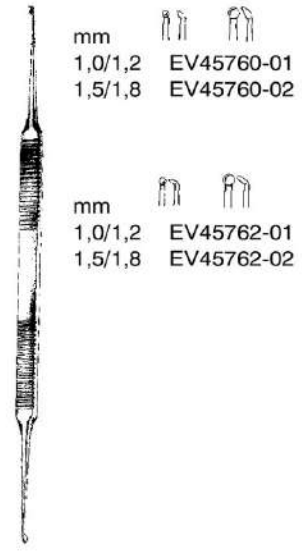
45°  
 EV45747-03  
 EV45747-06  
 EV45747-10

Dissektoren, Küretten, Elevatoren, Mikro-Meßsonde  
 Dissectors, Curettes, Elevators, Micro measuring rod  
 Disectores, Curetas, Elevadores, Sonda para mesurar  
 Dissettori, Curette, Elevatori, Sonda auricolare per misurare



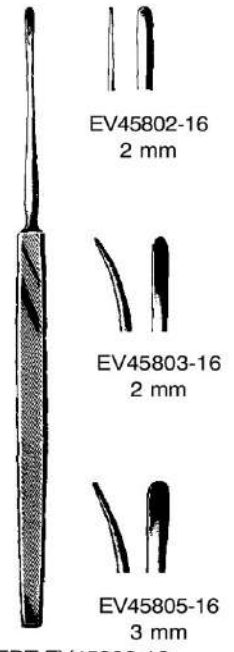
EV45751-16 EV45753-16  
 EV45755-16 EV45757-16

FISCH  
 EV45751-16 -  
 EV45757-16 16 cm, 6 1/4"

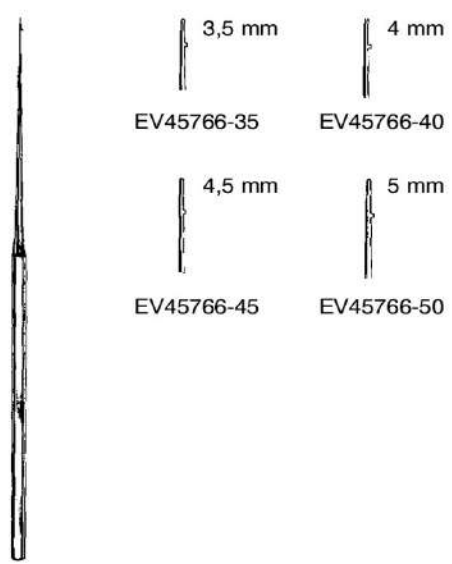


mm  
 1,0/1,2 EV45760-01  
 1,5/1,8 EV45760-02  
 mm  
 1,0/1,2 EV45762-01  
 1,5/1,8 EV45762-02

HOUSE  
 EV45760-01 -  
 EV45762-02 15 cm, 6"



EV45802-16  
 2 mm  
 EV45803-16  
 2 mm  
 EV45805-16  
 3 mm  
 LEMPERT EV45802-16 -  
 EV45805-16 16 cm, 6 1/4"



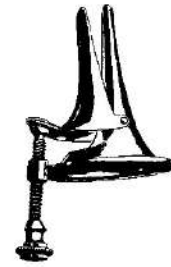
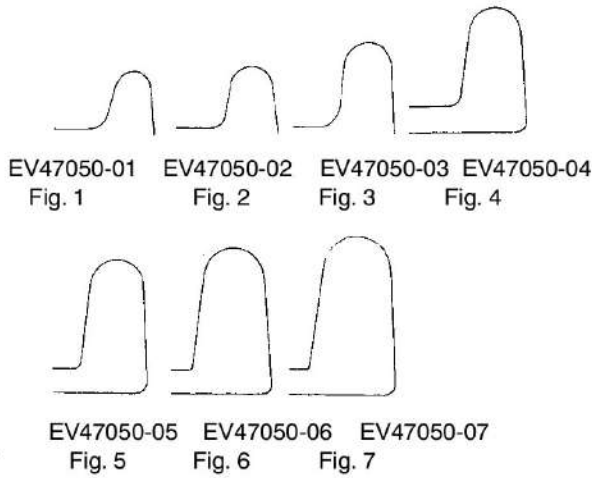
HOUSE  
 EV45766-35 - EV45766-50  
 16 cm, 6 1/4"



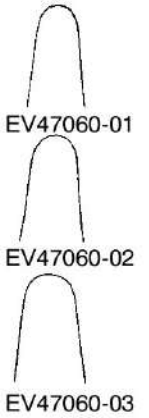
LEMPERT  
 EV45807-20  
 20,5 cm, 8"



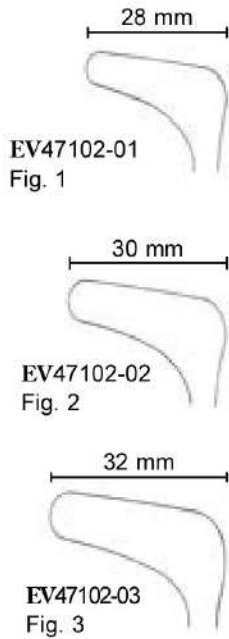
THUDICHUM  
EV47050-01 - EV47050-07



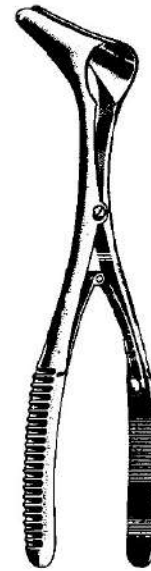
VOLTOLINI  
EV47060-01 - EV47060-03



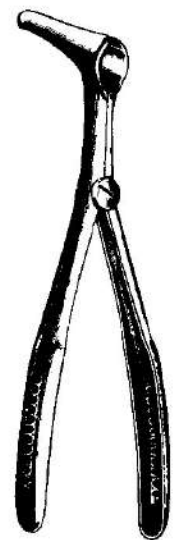
HARTMANN-HALLE  
EV47102-01 - EV47102-03  
15 cm, 6"



leichtes Modell  
lightweight  
mod. ligero  
mod. leggero



Mod. WIEN  
EV47112-01 25 mm  
EV47112-02 30 mm  
EV47112-03 35 mm



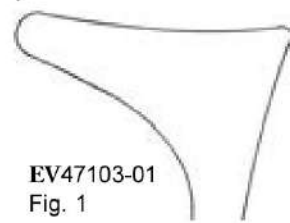
Mod. WIEN  
EV47113-03

Nasenspekula  
Nasal Specula  
Espéculos nasales  
Specoli nasali



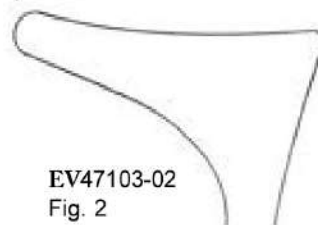
HARTMANN  
16 cm, 6 1/4"

30 mm



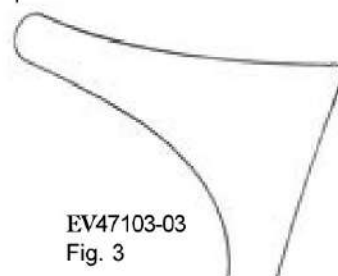
EV47103-01  
Fig. 1

33 mm



EV47103-02  
Fig. 2

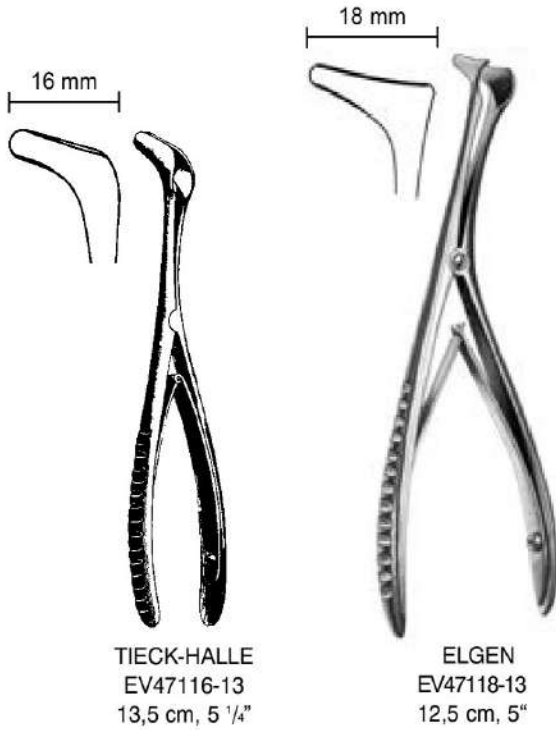
35 mm



EV47103-03  
Fig. 3

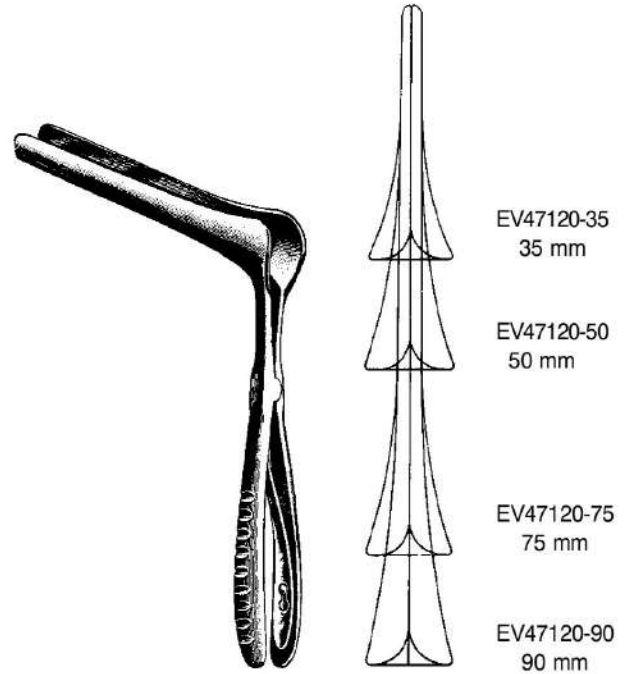


Nasenspekula, Kehlkopfspiegel  
 Nasal Specula, Laryngeal Mirrors  
 Espéculos nasales, espejos laríngeos  
 Specoli nasali, Specchi laringei

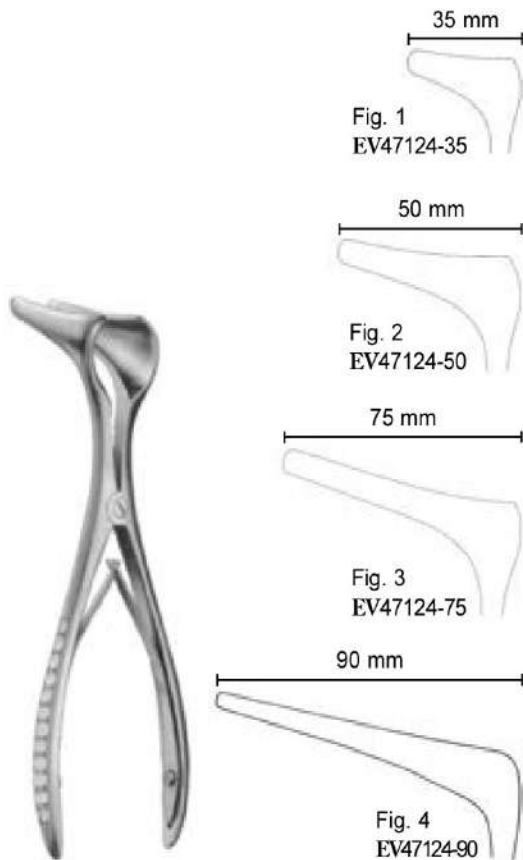


TIECK-HALLE  
 EV47116-13  
 13,5 cm, 5 1/4"

ELGEN  
 EV47118-13  
 12,5 cm, 5"



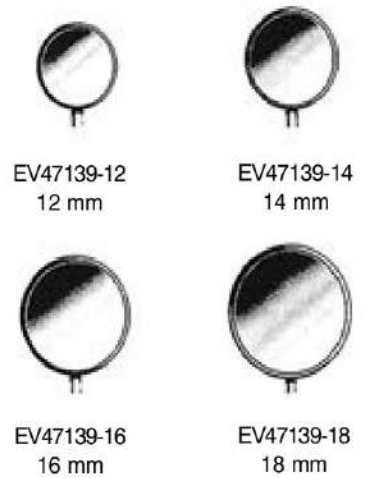
KILLIAN  
 EV47120-35 -  
 EV47120-90 13 cm,  
 5 1/8"



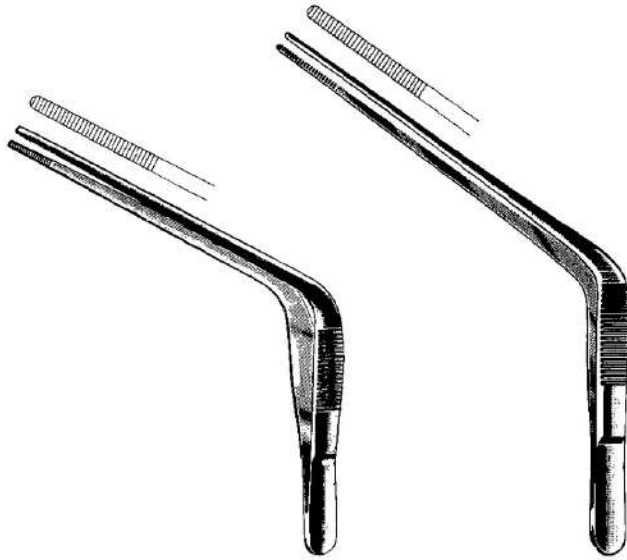
COTTLE  
 14 cm, 5 1/2"



MICHEL EV47139-12 -  
 EV47139-18 25 cm, 10"



Nasenpinzetten, Polypenzange  
 Ear Dressing Forceps, Ear Polypus Forceps  
 Pinzas auriculares, Pinzas para pólipos  
 Pinze auricolari, Pinze per polipi



TROELTSCH  
 EV47151-15  
 15 cm, 6"

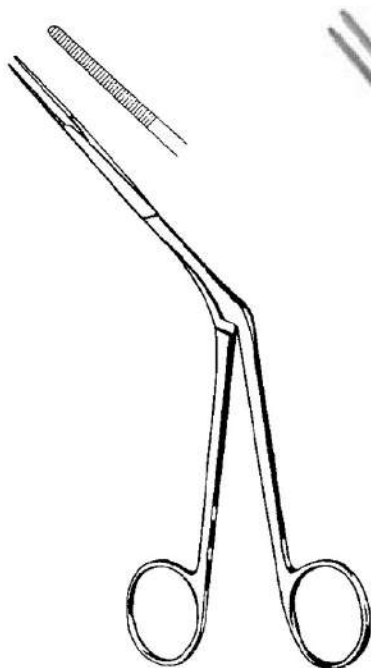
TROELTSCH  
 EV47151-18  
 18 cm, 7"



JANSEN-GRUENWALD  
 EV47154-20  
 20 cm, 8"



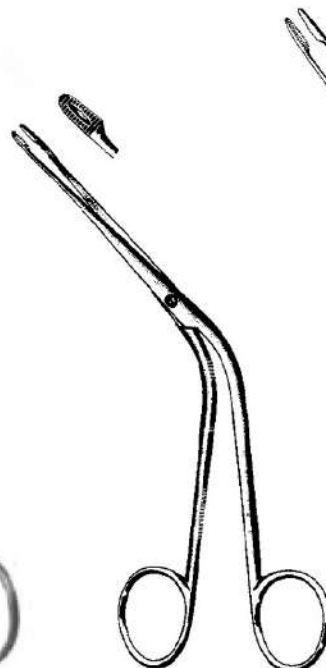
JANSEN  
 EV47155-20  
 20 cm, 8"



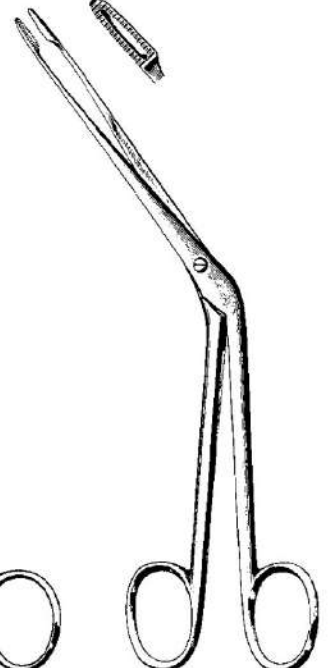
WESTMACOTT  
 EV47158-20  
 20 cm, 8"



LUBET-BARBON  
 EV47159-20  
 20 cm, 8"



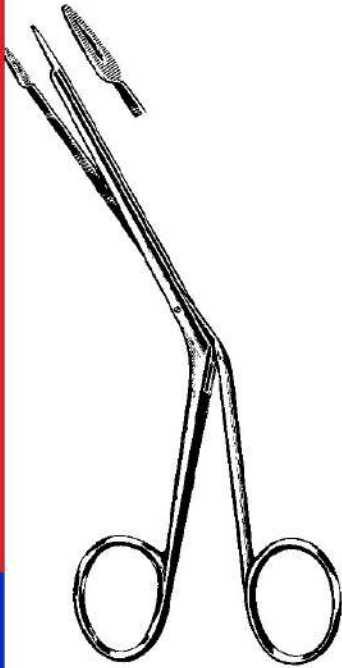
HARTMANN  
 EV47161-16  
 16 cm, 6 1/4"



HARTMANN  
 EV47161-20  
 20 cm, 8"

Polypenzangen, Septumzangen  
 Nasal Polypus and Septum Forceps  
 Pinzas para pólipos y para el tabique nasal  
 Pinze per polipi, Pinze per il setto nasale

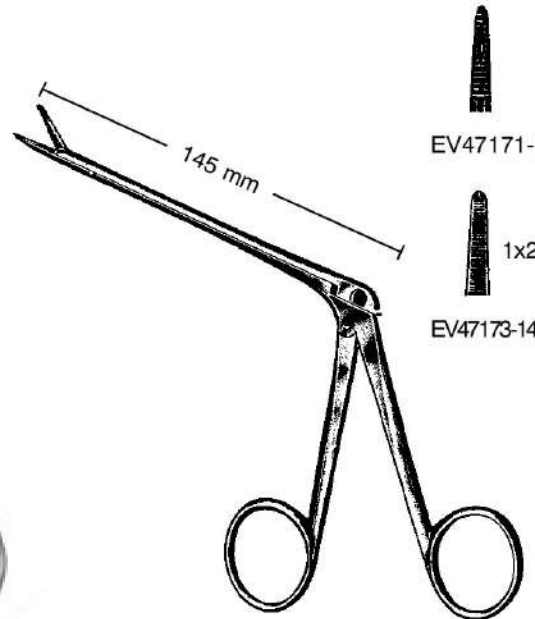
GERNAL SURGICAL



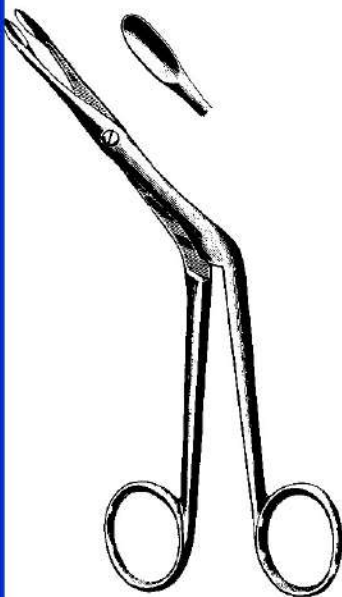
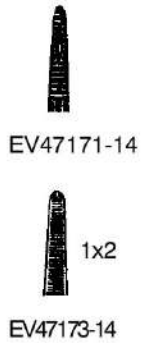
LITTAUER  
 EV47167-18  
 18 cm, 7"



HEYMANN-KNIGHT  
 EV47169-18  
 18 cm, 7"



NOYES  
 EV47171-14 -  
 EV47173-14 14,5  
 cm, 5 3/4"



HEYMANN  
 EV47181-18  
 18 cm, 7"



KNIGHT  
 EV47185-18  
 18 cm, 7"



BRUENINGS  
 EV47191-01 -  
 EV47191-04 19 cm, 7 1/2"

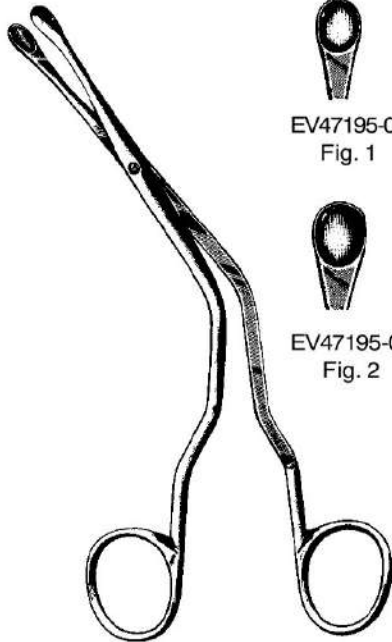
EV47191-01 EV47191-02

EV47191-03 EV47191-04

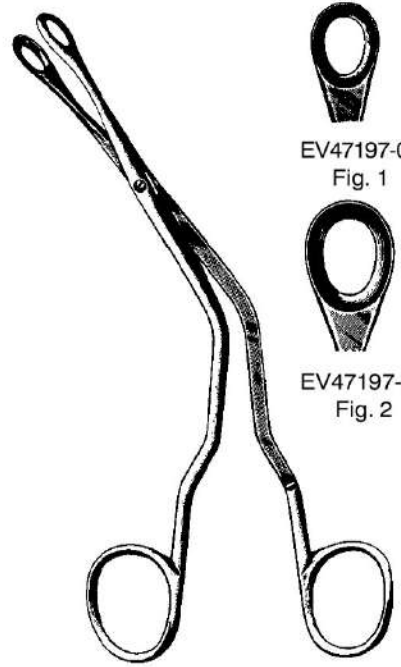
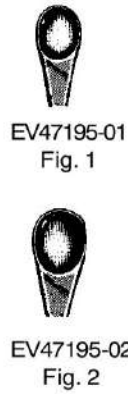
Scharfe Nasenzangen, Septumzangen  
 Nasal Cutting Forceps, Septum Forceps  
 Pinzas cortantes nasales y para el tabique nasal  
 Pinze taglianti nasali, Pinze per il setto nasale



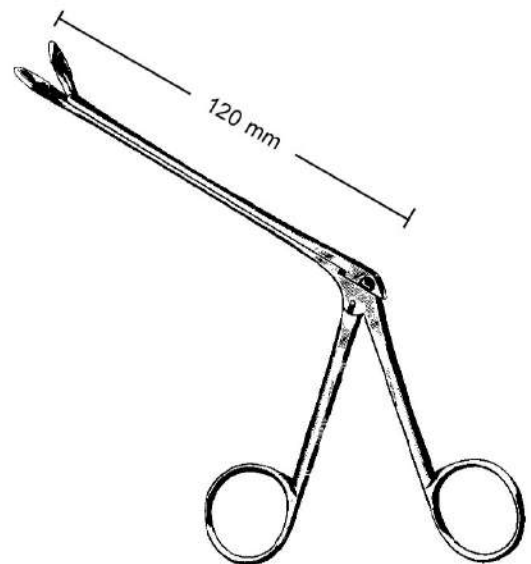
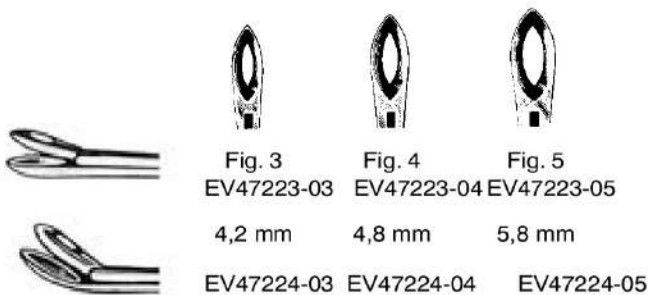
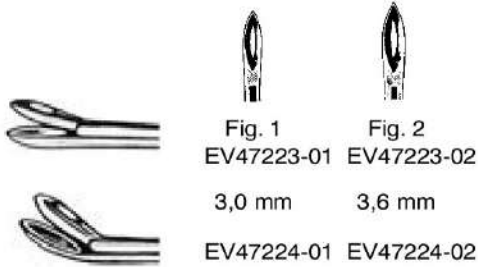
GRAIG  
 EV47192-16  
 18 cm, 7"



LUC  
 EV47195-01 -  
 EV47195-05 19 cm, 7 1/2"

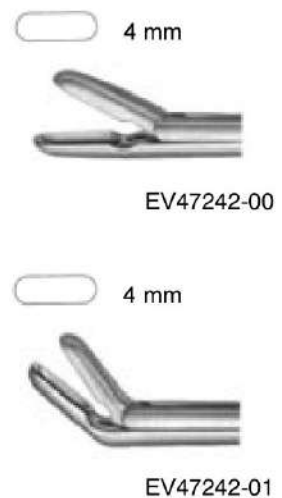
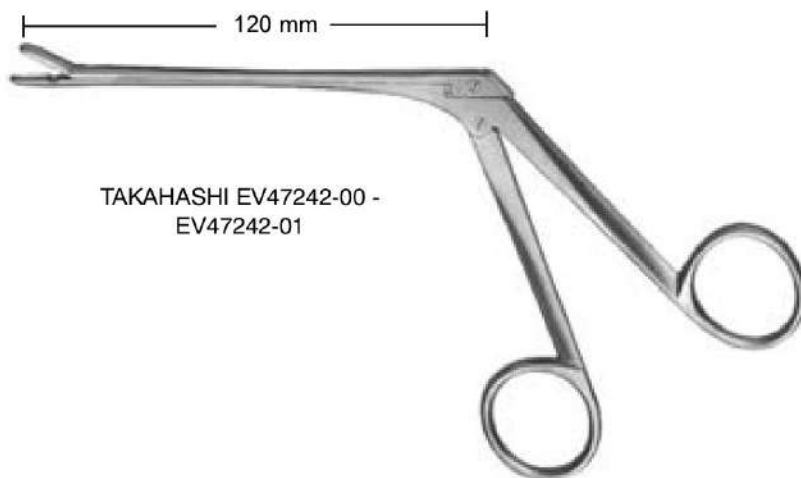
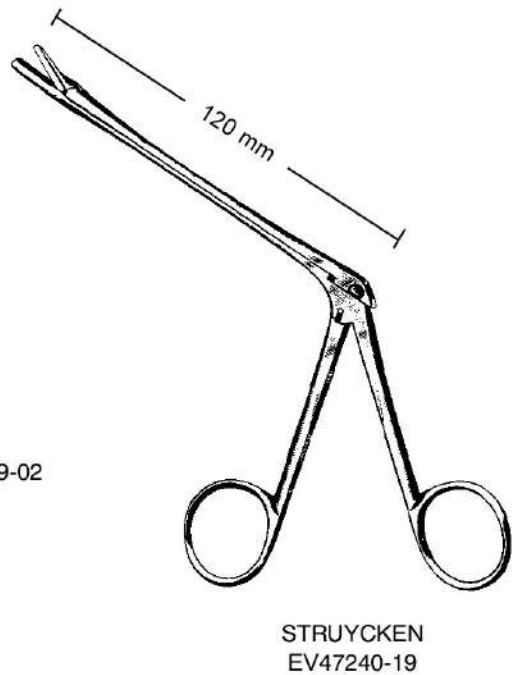
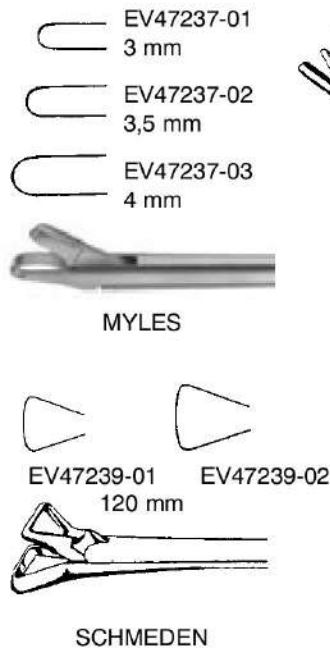
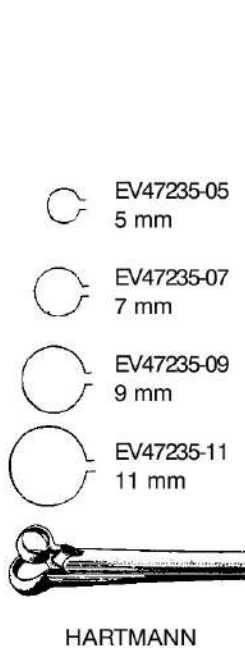


LUC  
 EV47197-01 -  
 EV47197-02 19 cm, 7 1/2"



WEIL-BLAKESLEY  
 EV47223-01 - EV47224-05

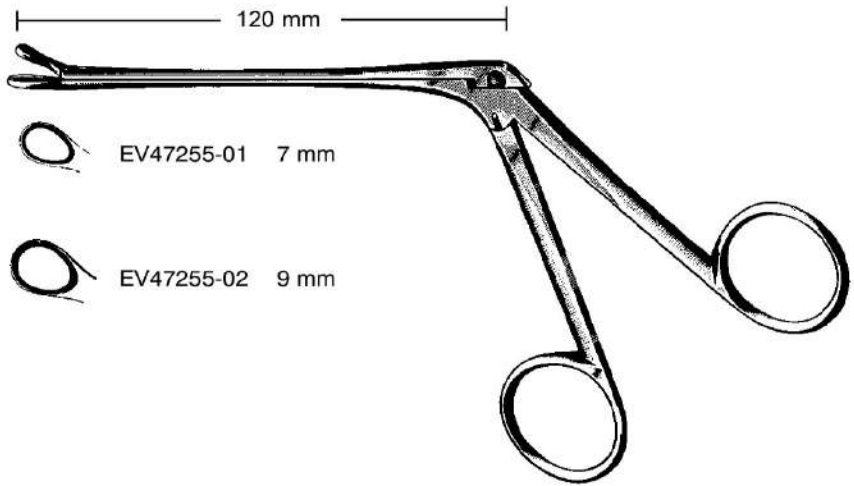
Scharfe Nasenzangen  
 Nasal Cutting Forceps  
 Pinzas cortantes nasales  
 Pinze taglianti nasali



Scharfe Nasenzangen, Septumzange, Kieferhöhlenstanze  
 Nasal Cutting Forceps, Septum Forceps, Antrum Punch Forceps  
 Pinzas cortantes nasales, Pinza para magullar tabique, Pinzas cortantes para maxilares  
 Pinze taglienti nasali, Pinza per ammaccare il setto, Pinze taglienti per seno mascellare



RUBIN  
 EV47251-21  
 21 cm, 8 1/4"



WATSON-WILLIAMS  
 EV47255-01



CAPLAN  
 EV47256-20  
 20 cm, 8"



KERRISON 3x3 mm  
 EV47303-03 4x4 mm  
 EV47303-04 5x5 mm  
 EV47303-05 6x6 mm  
 EV47303-06 17 cm, 6 3/4"

Kieferhöhlenstanze, Nasenschere  
 Antrum Punch Forceps, nasal scissors  
 Pinzas cortantes para maxilares, tijera nasal  
 Pinze sfenoidali, forbici nasali



EV47304-01 5x3,5 mm

EV47304-03 5x4 mm

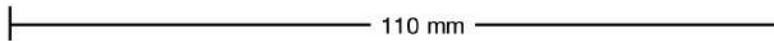


EV47304-02 5x3,5 mm

EV47304-04 5x4 mm



HAJEK-KOFLER  
 EV47304-01 - EV47304-04



EV47305-02  
 rechts gebogen  
 right curved curva  
 a la derecha curva  
 a destra

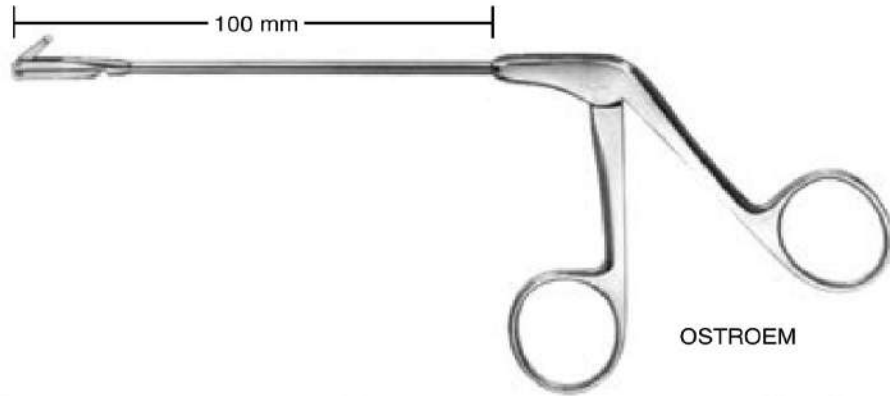


EV47305-03 links  
 gebogen left  
 curved curva a la  
 izquierda curva a  
 sinistra

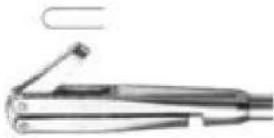


EV47305-01  
 gerade  
 straight  
 recta retta

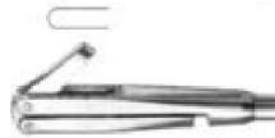
Knochenstanze, Septumzangen  
 Punches, Septum Forceps  
 Pinzas osteótomas, Pinzas para el tabique nasal  
 Pinze osteotomi, Pinze per il setto nasale



OSTROEM



EV47315-00  
 2 mm  
 oben schneidend  
 up cutting cortante  
 por arriba  
 tagliente in alto



EV47316-00  
 2 mm  
 rechts schneidend  
 right cutting cortante  
 a la derecha  
 tagliente a destra



EV47317-00  
 2 mm  
 links schneidend  
 left cutting  
 cortante a la izquierda  
 tagliente a sinistra



CITELLI  
 EV47311-10 1,0 mm  
 EV47311-25 2,5 mm  
 EV47311-30 3,0 mm



MIDDLETON-JANSEN  
 EV47323-19  
 19 cm, 7 1/2"



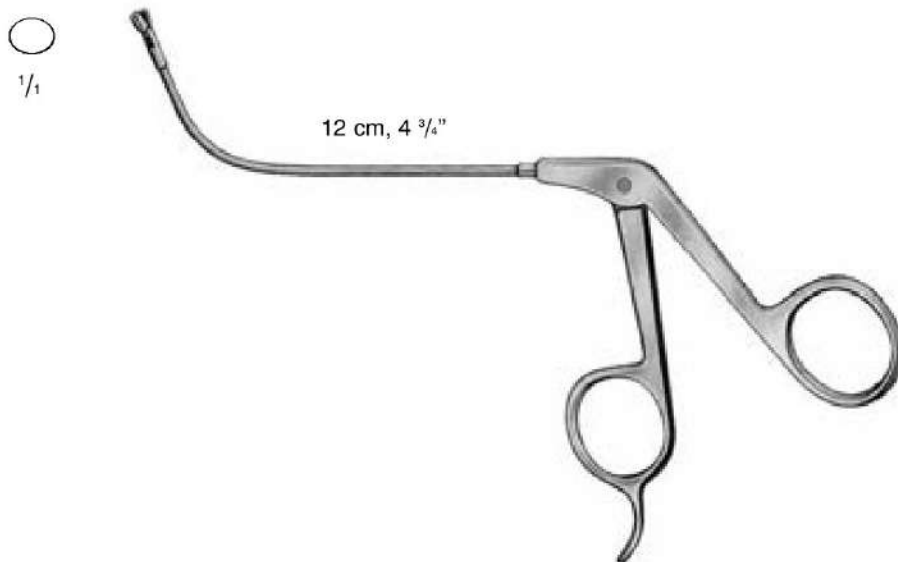
MIDDLETON-JANSEN  
 EV47325-19  
 19 cm, 7 1/2"



Kieferhöhlenstanze, Sinuskopie-Zangen  
 Antrum Punch Forceps, Sinuscopy forceps  
 Pinzas cortantes para maxilares, Pinzas para senoscopia  
 Pinze sfenoidali per seno mascellare, Pinze per sinuscopia



HAJEK-KOFLER  
 EV47316-16  
 3,5 mm



Maul  
 jaw  
 boca  
 morso

horizontal öffnend  
 horizontal cutting  
 abierta horizontal  
 apertura orizzontale

vertikal öffnend  
 vertical cutting  
 abierta vertical  
 apertura verticale

65° ○ 3 mm rund  
 70° ○ } oval  
 90° ○ }  
 110° ○ }

EV47317-65  
 EV47317-70  
 EV47317-90  
 EV47317-11

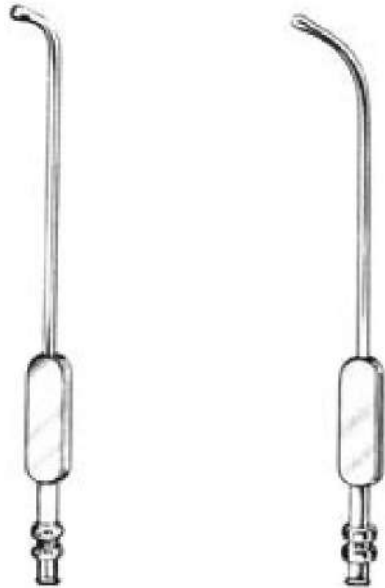
EV47318-65  
 EV47318-70  
 EV47318-90  
 EV47318-11

Zirkular Stanze  
Circular Forceps  
Pinza circular  
Pinza circolare



EV47319-35 3,5 mm  
EV47319-45 4,5 mm

Spülkanülen, Stirnhöhlendilatator  
 cannulas, Frontal sinus bougies  
 cánulas, Dilatador para el seno  
 cannulas, Dilatatore per seno frontale



EICKEN (KILLIAN)  
 14,5 cm, 5 3/4"  
 Ø

|            |        |            |
|------------|--------|------------|
| EV47331-20 | 2,0 mm | EV47332-20 |
| EV47331-25 | 2,5 mm | EV47332-25 |
| EV47331-30 | 3,0 mm | EV47332-30 |
| EV47331-40 | 4,0 mm | EV47332-40 |



Ø mm RITTER-HALLE  
 2,5 EV47342-25  
 3,0 EV47342-30  
 4,0 EV47342-40



Kiefer- und Stirnhöhlen-Spülkanülen, Saugraspatorium  
Antrum and Frontal Sinus Wash Cannulas, Suction Raspatory  
Cànulas lavadoras para seno maxilar y seno frontal, Legra de succión  
Cannule per seno mascellare e seno frontale, Raspatorio con aspiratore



KILLIAN Ø  
1,5 mm  
EV47345-15



GUILEN 19  
cm, 7 1/2"  
EV47347-20

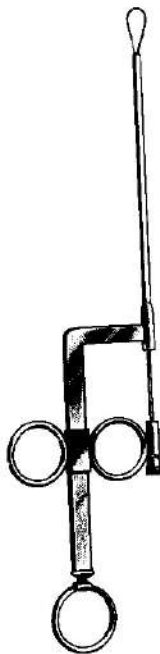
Polypenschnürer  
Nasal Polypus Snares  
Polipótomos  
Serranodi



KRAUSE-VOSS  
EV47350-26  
26 cm, 10 1/4"



KRAUSE  
EV47351-26  
26 cm, 10 1/4"



WILDE  
EV47352-24  
24 cm, 9 1/2"



Bündel mit 12 Stück  
Bundle with 12 pieces  
12 piezas atados  
confezione di 12 pezzi

EV47355-03 0,3 mm



EV47370-16  
EV47371-16 stumpf,  
blunt,  
romos, smussi



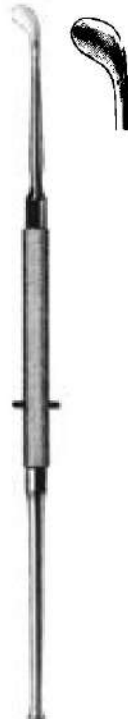
EV47372-16  
EV47373-16 spitz,  
pointed, agudos,  
acuti



JOSEPH EV47370-16 -  
EV47373-16 16 cm, 6  
<sup>1</sup>/<sub>4</sub>"



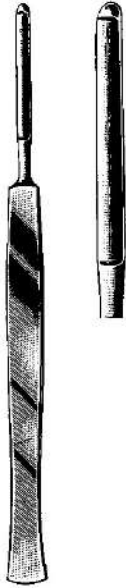
FREER  
EV47374-16  
16,5 cm, 6 <sup>1</sup>/<sub>2</sub>"



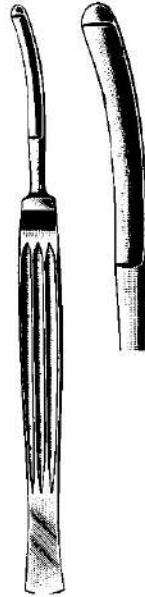
FREER  
EV47375-19  
19 cm, 7 <sup>1</sup>/<sub>2</sub>"



JOSEPH  
EV47375-16  
16,5 cm, 6 <sup>1</sup>/<sub>2</sub>"



JOSEPH  
 EV47376-16  
 16 cm, 6 1/4"



CONVERSE  
 EV47379-16  
 16 cm, 6 1/4"



COTTLE  
 EV47380-15  
 15 cm, 6"



COTTLE  
 EV47382-15  
 15 cm, 6"



JOSEPH  
 EV47384-15  
 15 cm, 6"



JOSEPH  
 EV47385-15  
 15 cm, 6"



ELGEN  
 19 cm, 7 1/2"



EV47386-01  
 spitz pointed  
 agudo acuto



EV47386-02  
 stumpf blunt  
 romo smusso



ANTRUM  
 19 cm, 7 1/2"



EV47387-01 vor-  
 wärts schneidend  
 forward cutting corte  
 hacia adelante  
 taglio in avanti

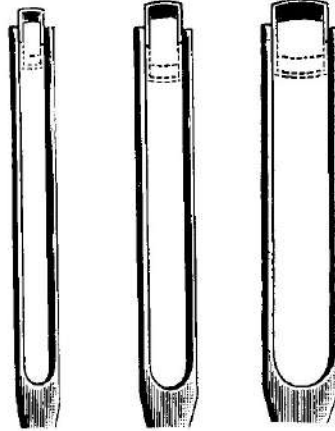


EV47387-02 rück-  
 wärts schneidend  
 backward cutting  
 corte hacia atras  
 taglio retrograde

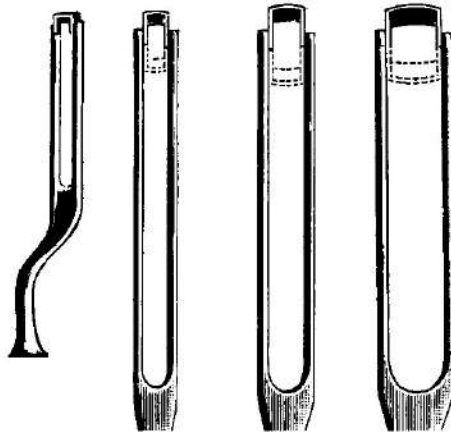
Schwingmesser  
Septum Swivel Knives  
Bisturios para el tabique nasal  
Coltelli per setto



BALLENGER  
EV47390-03 -  
EV47392-05  
20 cm, 8"



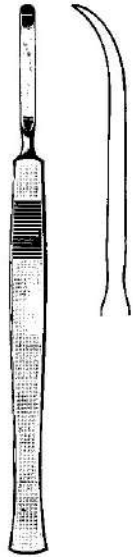
EV47390-03 3 mm  
EV47390-04 4 mm  
EV47390-05 5 mm



EV47392-03 3 mm  
EV47392-04 4 mm  
EV47392-05 5 mm



Septum Elevatoren  
 Septum Elevators  
 Elevadores para el tabique  
 Elevatori per setto



EV47410-04  
4 mm



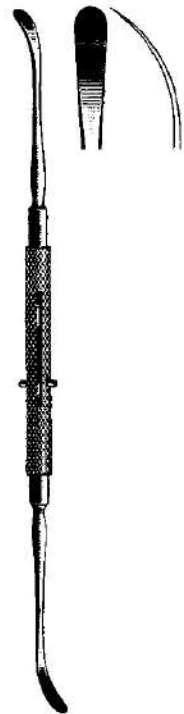
EV47410-05  
5 mm



HALLE  
 EV47410-16  
 16.5 cm, 6 1/2"



JOSEPH  
 EV47411-16  
 16 cm, 6 1/4"



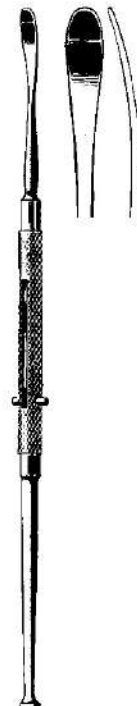
ROGER  
 EV47413-19  
 19 cm, 7 1/2"



MASING  
 EV47414-21  
 22 cm, 8 3/4"



FREER  
 EV47415-18  
 18 cm, 7"



FREER  
 EV47417-19  
 19 cm, 7 1/2"



FREER  
 EV47419-19  
 19 cm, 7 1/2"

Septum Elevatoren  
Septum Elevators  
Elevadores para el tabique  
Elevatori per setto



**KILLIAN**  
EV47420-01  
18,5 cm, 7 1/4"



**PIERCE**  
EV47420-02  
21 cm, 8 1/4"



**SINUS**  
EV47420-03  
18 cm, 7"



**PENNINGTON**  
EV47420-04  
21 cm, 8 1/4"



**McKENTY**  
EV47420-20  
22 cm, 8 3/4"



**HOWARTH**  
EV47421-21  
21,5 cm, 8 1/2"

Septum Elevatoren  
Septum Elevators  
Elevadores para el tabique  
Elevatori per setto



COTTLE  
EV47421-23  
23 cm, 9"



COTTLE JOSEPH  
EV47422-22 22  
cm, 8 3/4"



COTTLE  
EV47423-22  
22 cm, 8 3/4"



COTTLE  
EV47424-16  
16 cm, 6 1/4"



COTTLE  
EV47425-19  
19 cm, 7 1/2"



KILLIAN  
EV47426-22  
22 cm, 8 3/4"



HAJEK-BALLENGER  
EV47428-21  
22 cm, 8 3/4"



BALLENGER  
EV47430-22  
22 cm, 8 3/4"

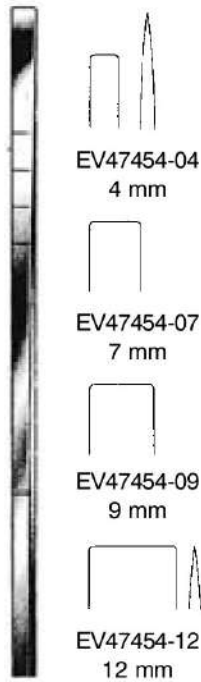


FREER  
EV47450-04  
15 cm, 6"



FREER  
EV47451-04  
15 cm, 6"

Osteotome, Knorpelquetscher  
 Osteotomes, Cartilage crusher  
 Osteótomos, Macha cadera  
 Osteotomi, Tritacartilagine



EV47454-04  
4 mm

EV47454-07  
7 mm

EV47454-09  
9 mm

EV47454-12  
12 mm

COTTLE  
 EV47454-04 -  
 EV47454-12 18 cm,  
 7"



6 mm

COTTLE  
 EV47455-06  
 18 cm, 7"



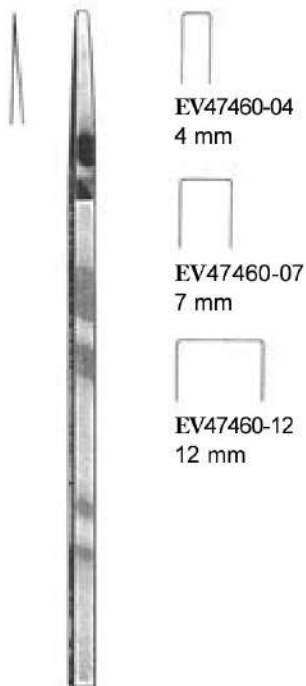
EV47458-04  
4 mm

EV47458-07  
7 mm

EV47458-09  
9 mm

EV47458-12  
12 mm

COTTLE  
 EV47458-04 -  
 EV47458-12 18 cm,  
 7"

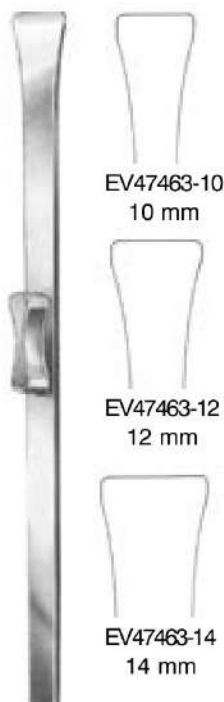


EV47460-04  
4 mm

EV47460-07  
7 mm

EV47460-12  
12 mm

COTTLE  
 18 cm, 7"

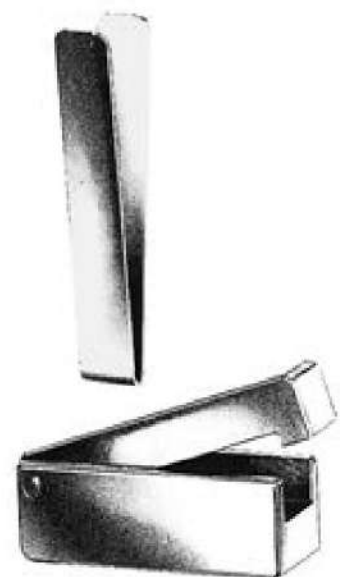


EV47463-10  
10 mm

EV47463-12  
12 mm

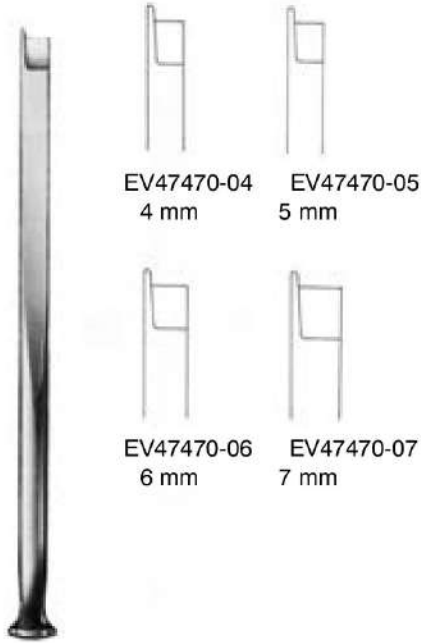
EV47463-14  
14 mm

RUBIN  
 18,5 cm, 7 1/8"



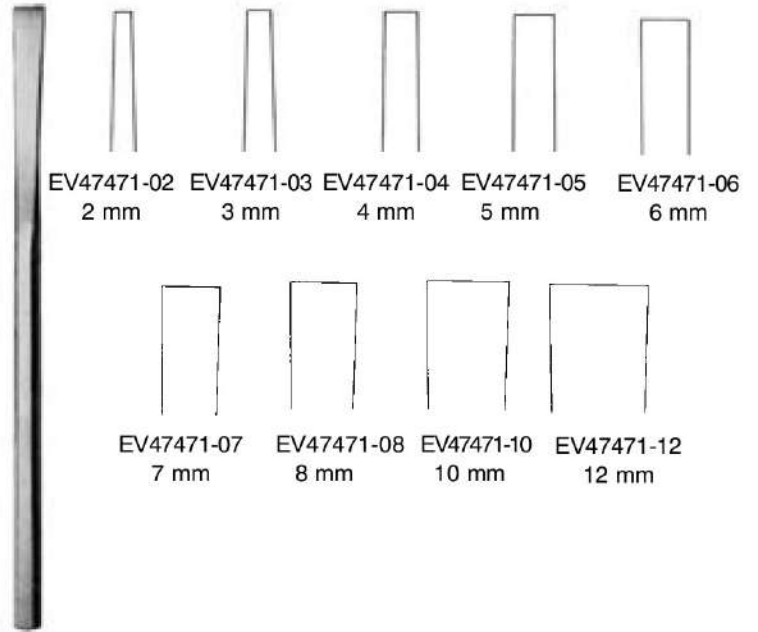
COTTLE  
 Knorpelquetscher  
 EV47461-00

Osteotome, Septum Meißel  
 Osteotomes, Rhinoplastic Chisels  
 Osteótomos, Cinceles para la plàstica nasal  
 Osteotomi, Scalpelli per plastica nasale



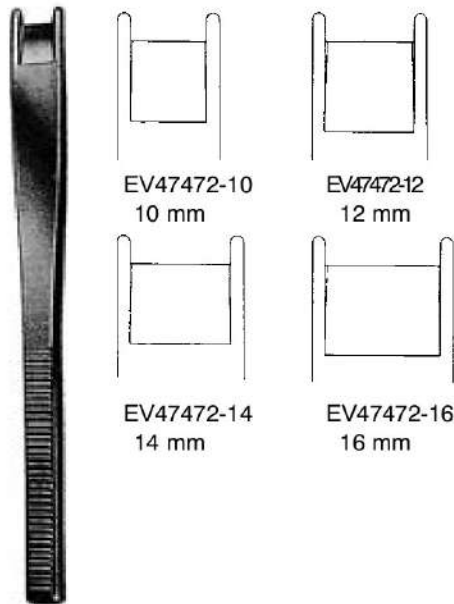
EV47470-04 4 mm  
 EV47470-05 5 mm  
 EV47470-06 6 mm  
 EV47470-07 7 mm

FOMON EV47470-04 -  
 EV47470-07 17 cm, 6 3/4"



EV47471-02 2 mm  
 EV47471-03 3 mm  
 EV47471-04 4 mm  
 EV47471-05 5 mm  
 EV47471-06 6 mm  
 EV47471-07 7 mm  
 EV47471-08 8 mm  
 EV47471-10 10 mm  
 EV47471-12 12 mm

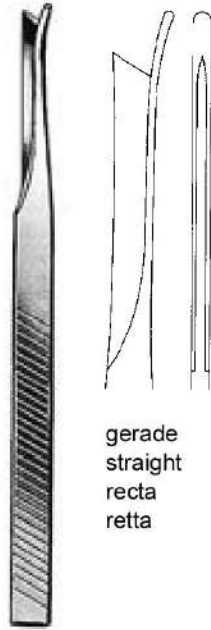
SHEEHAN EV47471-07  
 - EV47471-12 16 cm, 6 3/4"



EV47472-10 10 mm  
 EV47472-12 12 mm  
 EV47472-14 14 mm  
 EV47472-16 16 mm

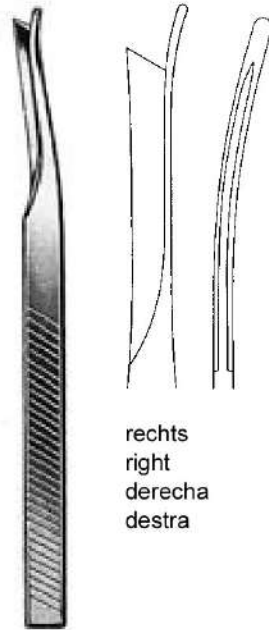
CINELLI EV47472-10 -  
 EV47472-16 16 cm, 6 1/4"

Septum Meißel, Osteotom  
 Rhinoplastic Chisels, Osteotom  
 Cinceles para la plástica nasal, Osteótom  
 Scalpelli per plastica nasale, Osteotom



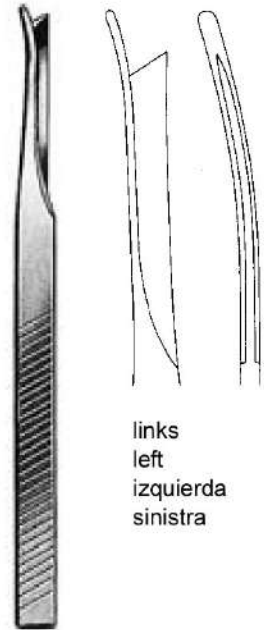
gerade  
 straight  
 recta  
 retta

SILVER  
 EV47473-01  
 18 cm, 7"



rechts  
 right  
 derecha  
 destra

SILVER  
 EV47473-02  
 18 cm, 7"



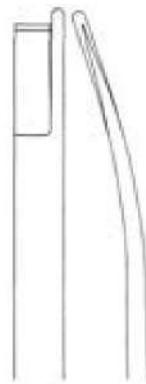
links  
 left  
 izquierda  
 sinistra

SILVER  
 EV47473-03  
 18 cm, 7"



EV47474-01

rechts  
 right  
 derecha  
 destra



EV47474-02

links  
 left izquier-  
 da sinistra



EV47474-03

gerade  
 straight  
 recta retta

NEIVERT-ANDERSON  
 EV47474-01 - EV47474-03  
 20,5 cm, 8" 7 mm

Septum-Hohlmeißel, Osteotom  
 Septum Gouges, Osteotom  
 Gubias para tabique nasal, Osteótom  
 Sgorbie per il setto nasale, Osteotom



KILLIAN  
 EV47481-05  
 16 cm, 6 1/4"



KILLIAN-CLAUS  
 EV47482-05  
 17 cm, 6 3/4"



mm HAJEK  
 4 EV47484-04  
 6 EV47484-06  
 8 EV47484-08  
 16 cm, 6 1/4"



WEST  
 EV47486-16  
 16 cm, 6 1/4"



WEST  
 EV47487-16  
 16 cm, 6 1/4"

6 mm



FREER  
 EV47489-16  
 16 cm, 6 1/4"

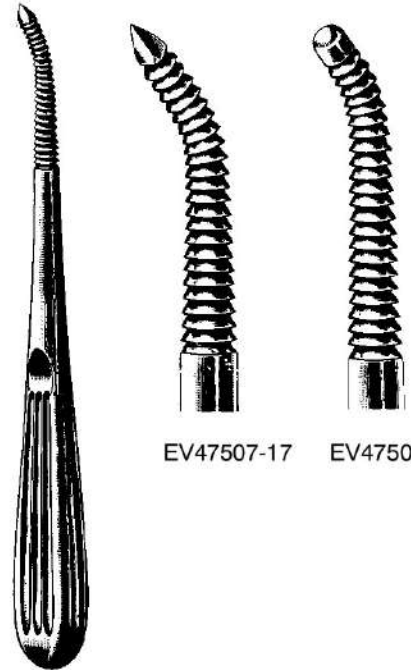
Knochenfeile, Nasenraspeln  
 Bone File, Nasal Rasps  
 Limas para hueso, Escofinas nasales  
 Lime per ossa, Raspa nasale



JOSEPH  
 EV47502-16  
 16 cm, 6 1/4"

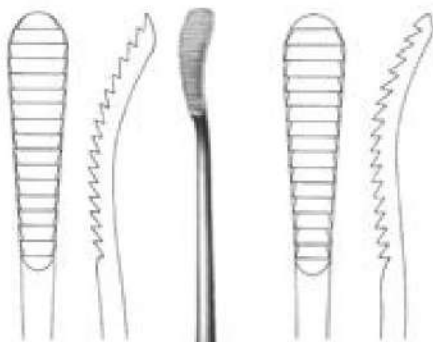


MALTZ  
 EV47504-18  
 18 cm, 7"

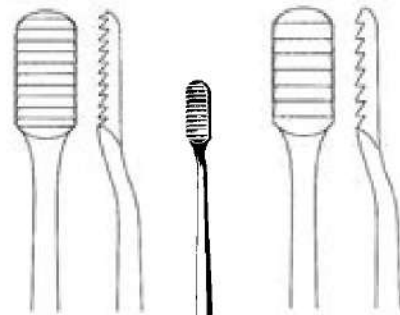


EV47507-17    EV47507-19

WIENER EV47507-17 -  
 EV47507-19 18 cm, 7"



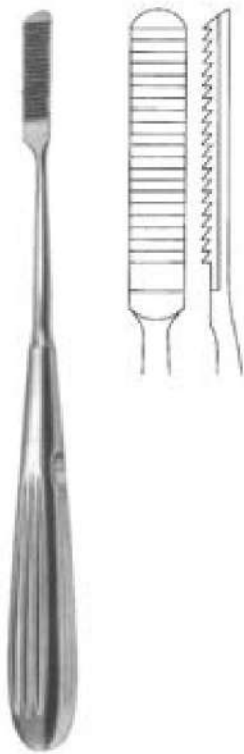
AUFRICHT  
 EV47511-21    21 cm, 8 1/4"    EV47513-21



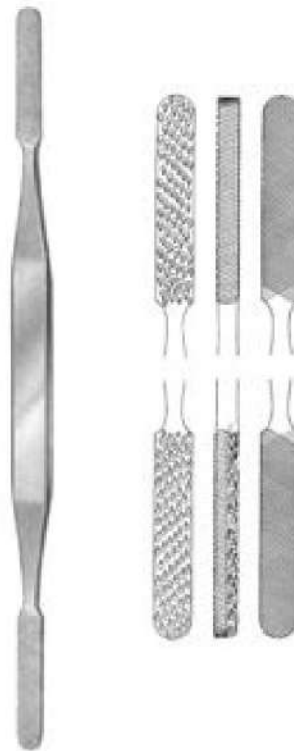
JOSEPH (LEWIS) EV47514-16  
 18 cm, 7"    EV47516-16



Nasenraspeln  
 Nasal Rasps  
 Escofinas nasales  
 Raspa nasale



MALTZ (COTTLE)  
 EV47518-21 21  
 cm, 8 1/4"



FOMON  
 EV47520-21  
 21 cm, 8 1/4"



MILLER  
 18 cm, 7"



EV47521-01

5 mm



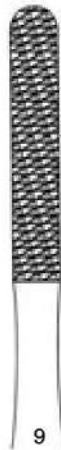
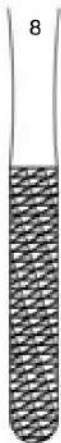
EV47521-02

4,3 mm



EV47521-03

5 mm



FOMON

EV47522-01 - EV47522-09 TC  
 20 cm, 8"

Fig. 1/2

EV47522-01 TC

Fig. 3/4

EV47522-04 TC

Fig. 5/6

EV47522-05 TC

Fig. 7/8

EV47522-07 TC

Fig. 9/10

EV47522-09 TC

Nasenraspeln, Nasensägen  
 Nasal Rasps, Nasal Saws  
 Escofinas nasales, Sierras nasales  
 Raspa nasale, Seghe nasale



PEET  
 EV47523-01  
 EV47523-02  
 19 cm, 7 1/2"



GALLAHER  
 EV47526-16 - EV47529-16  
 16 cm, 6 1/4"



Fig. 1  
 EV47526-16



Fig. 2  
 EV47527-16

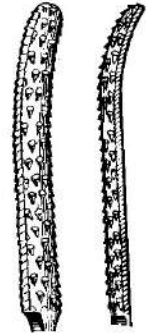
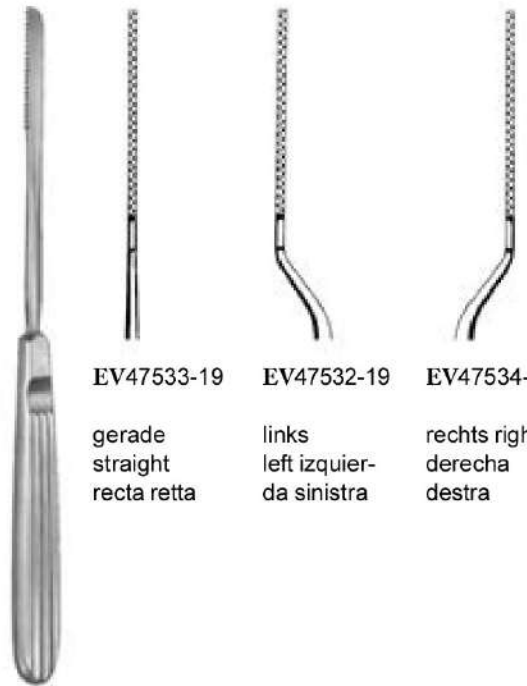


Fig. 3  
 EV47529-16



JOSEPH EV47535-01  
 EV47535-02 17 cm, 6 3/4"



JOSEPH  
 19 cm, 7 1/2"

|                                   |                                       |                                   |
|-----------------------------------|---------------------------------------|-----------------------------------|
| EV47533-19                        | EV47532-19                            | EV47534-19                        |
| gerade<br>straight<br>recta recta | links<br>left izquier-<br>da sinistra | rechts right<br>derecha<br>destra |

Nasenhaken  
Nasal retractor  
Retradores nasales  
Retrattori nasali



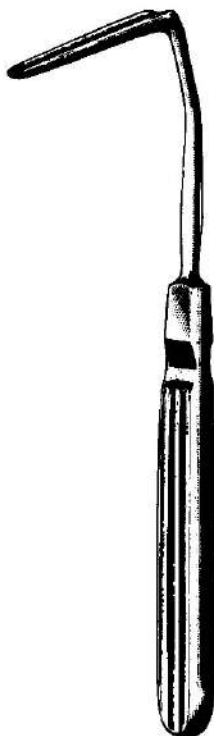
COTTLE  
EV47540-16  
16 cm, 6 1/4"



MASIG  
EV47541-14  
14 cm, 5 1/2"



AUFRICHT  
EV47542-12  
12 cm, 4 3/4"



AUFRICHT  
EV47551-16  
16 cm, 6 1/4"



AUFRICHT  
EV47551-16L  
16 cm, 6 1/4"



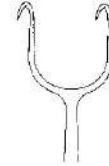
MASIG-NEIVERT  
EV47552-16 16  
cm, 6 1/4"

Nasenhaken, Hauthäkchen  
 Nasal retractor  
 Retractores nasales, Ganchos para la piel  
 Retrattori nasali, uncini nasali

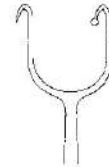
10 x 12 mm



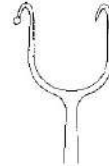
COTTLE  
 EV47553-15  
 15 cm, 6"



EV47554-01



EV47554-02



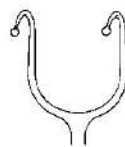
EV47554-03

COTTLE  
 14,5 cm, 5 3/4"

3 x 11 mm



KILNER  
 EV47555-08  
 8 cm, 3 1/8"



FOMON  
 EV47556-16  
 16 cm, 6 1/4"



FOMON  
 EV47557-17  
 17 cm, 6 3/4"

Hauthäkchen, Columella Pinzette  
 Retractor, Columnella forceps  
 Ganchos para la piel, Pinza para columnela  
 Uncini, Pinzetta columella



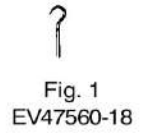
FREER  
 EV47558-15  
 15 cm, 6"



COTTLE-NEIVERT  
 EV47559-20  
 20 cm, 8"



GILLIES  
 18 cm, 7"



LANGE  
 EV47563-22  
 23 cm, 9"



COTTLE  
 EV47564-16  
 16 cm, 6 1/4"



COTTLE  
 EV47565-10  
 10 cm, 4"



CONVERSE  
 EV47566-12  
 12 cm, 4 3/4"

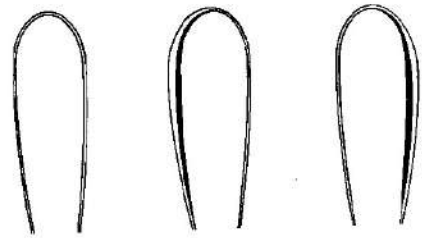
Septumrichtzangen, Küretten  
 Septum Straightening Forceps, Curettes  
 Pinza para enderezar el tabique nasal, curetas  
 Pinza per la plastica nasale, Curette



ASCH  
 EV47571-23  
 23 cm, 9"



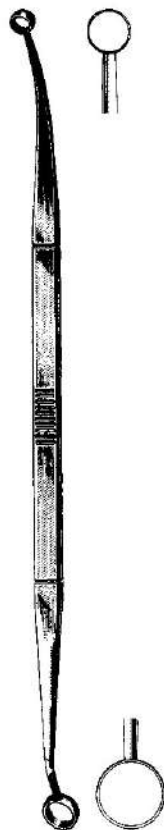
WALSHAM EV47572-23 -  
 EV47575-23 23 cm, 9"



EV47572-23  
 gerade  
 straight  
 recta retta

EV47573-23  
 links left  
 izquierda a  
 sinistra

EV47575-23  
 rechts right  
 derecha a  
 destra



FAULKNER  
 EV47601-21  
 21 cm, 8 1/4"



COAKLEY EV47607-01  
 - EV47607-06 17 cm,  
 6 3/4"



EV47607-01  
 Fig. 1



EV47607-02  
 Fig. 2



EV47607-03  
 Fig. 3



EV47607-04  
 Fig. 4



EV47607-05  
 Fig. 5



EV47607-06  
 Fig. 6

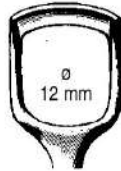
Ringmesser  
Adenoid Currettes  
Cuchillos para vegetaciones adenoides  
Coltelli per vegetazioni adenoide



EV47620-00  
Fig. 0



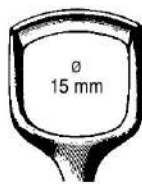
EV47620-01  
Fig. 1



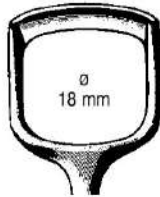
EV47620-02  
Fig. 2



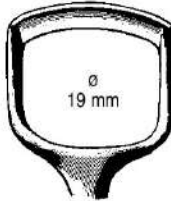
BECKMANN EV47620-01  
- EV47620-06 22 cm, 8 3/4"



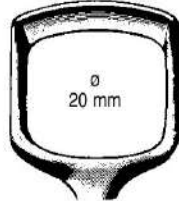
EV47620-03  
Fig. 3



EV47620-04  
Fig. 4



EV47620-05  
Fig. 5



EV47620-06  
Fig. 6



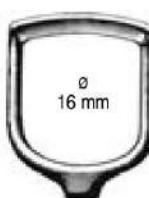
St. CLAIR-THOMSON  
EV47636-01 -  
EV47636-04 21 cm, 8 1/4"



EV47636-01  
Fig. 1



EV47636-02  
Fig. 2



EV47636-03  
Fig. 3



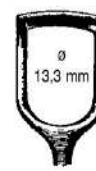
EV47636-04  
Fig. 4



BARNHILL EV47630-01 -  
EV47630-04 21 cm, 8 1/4"



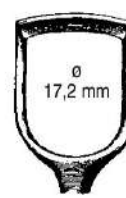
EV47630-00  
Fig. 0



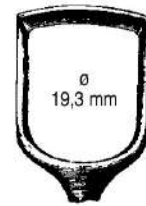
EV47630-01  
Fig. 1



EV47630-02  
Fig. 2



EV47630-03  
Fig. 3



EV47630-04  
Fig. 4



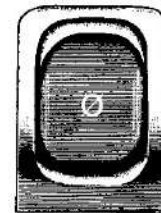
LAFORCE EV47641-01 -  
EV47641-03 25 cm, 10"



EV47641-01  
Fig. 1  
ø 12 mm



EV47641-02  
Fig. 2  
ø 16 mm



47641-03  
Fig. 3  
ø 18 mm

Ersatzklingen allein, gelocht  
Spare blades, perforated  
Hojas de repuesto, perforadas  
Lame di ricambio, forate

Fig. 1 EV47642-01  
Fig. 2 EV47642-02  
Fig. 3 EV47642-03



Zungenspatel, Wangen- und Lippenhalter  
 Tongue Depressors, Cheek and Lip Retractors  
 Baja-lenguas, Separadores para labios y mejillas  
 Abbassalingua, Divaricatori per guance e labbra

Holz  
 wood  
 madera  
 legno



EV49102-16  
 16 cm, 6 1/4"  
 Pack. à 100

21,7 mm



MAYO  
 EV49103-17  
 17 cm, 6 3/4"

21,4 mm



KROENIG  
 EV49104-15  
 15 cm, 6"

23 mm



FRENZEL  
 EV49105-16  
 16,5 cm, 6 1/2"

13 mm

16 mm



EV49106-01  
 14,5 cm, 5 3/4"

15 mm



EV49106-02  
 14,5 cm, 5 3/4"

15 mm



BRUENINGS  
 EV49107-19  
 19 cm, 7 1/2"

19 mm

20 mm



CAWOOD-MINNESOTA  
 EV49108-15  
 15 cm, 6"

20 mm

23 mm



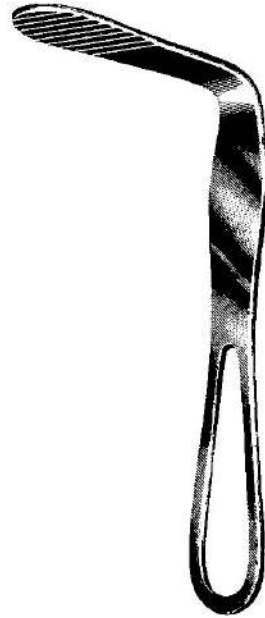
BUCHWALD  
 EV49109-19  
 19 cm, 7 1/2"

19 mm

Zungendrucker  
Tongue Depressors  
Baja-lenguas  
Abassalingua



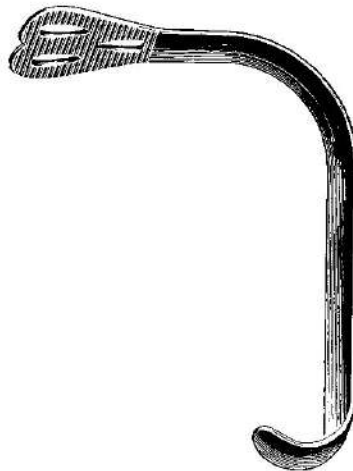
MORITZ-SCHMIDT  
EV49110-19 19  
cm, 7 1/2"



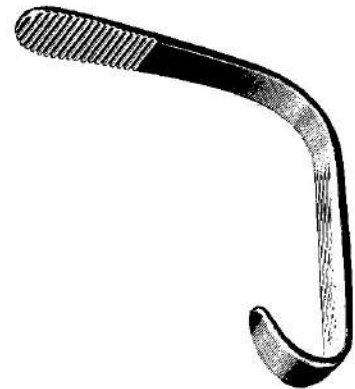
HARTMANN  
EV49111-15  
15 cm, 6"



EV49115-01 EV49115-02  
Fig. 1 Fig. 2  
14 cm, 5 1/2" 15 cm, 6"

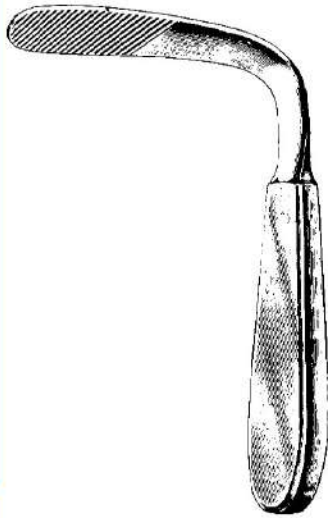


WIEDER EV49115-01 -  
EV49115-02

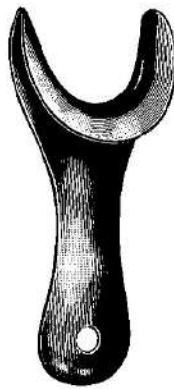


ANDREW  
EV49117-11  
11 cm, 4 3/8"

Zungendrucker, Wangen- und Lippenhalter, Zungenzangen  
 Tongue Depressor, Cheek and Lip Retractor, Tongue Holding Forceps  
 Baja-lenguas, Separadores para labios y mejillas, Pinza tira-lenguas  
 Abassalingua, Divaricatori per guance e labbra, Pinza tiralingua



TOBOLD  
 EV49119-14  
 14,5 cm, 5 3/4"



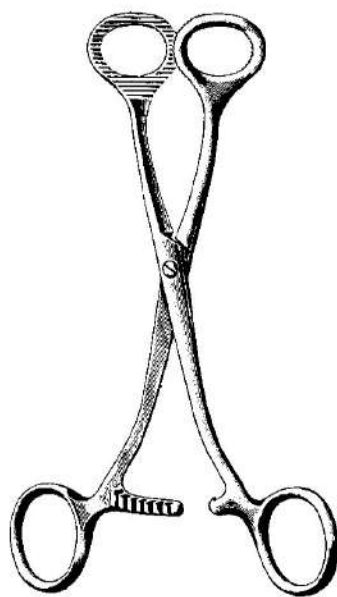
EV49230-11  
 11 cm, 4 3/8"



STERNBERG  
 EV49231-12 12 cm, 4 3/4"  
 EV49231-14 14 cm, 5 1/2"  
 EV49231-16 16 cm, 6 1/4"



EV49235-19  
 19 cm, 7 1/2"

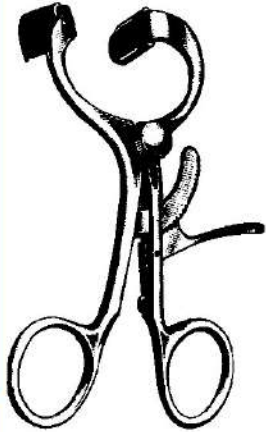


COLLIN  
 EV49250-16 16 cm, 6 1/4"  
 EV49250-18 18 cm, 7"

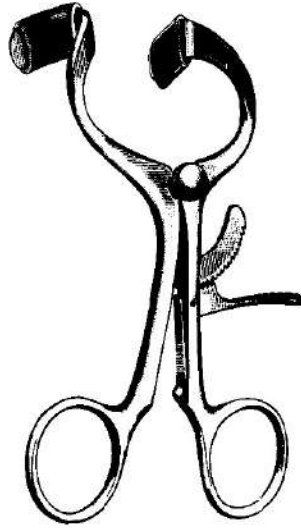


EV49255-99  
 1 Paar  
 1 Pair  
 1 pareja  
 1 coppia

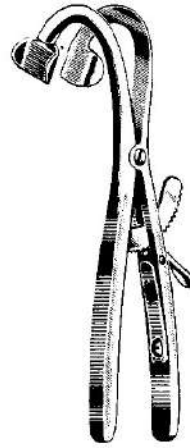
YOUNG  
 EV49255-16  
 16 cm, 6 1/4"



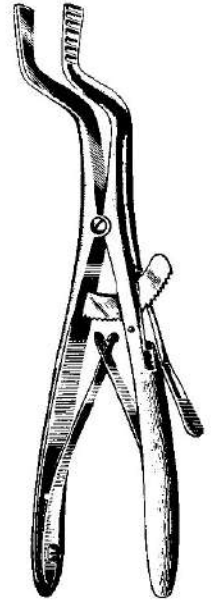
DOYEN-JANSEN (MOLT)  
EV49265-12 12 cm, 4 <sup>3</sup>/<sub>4</sub>"



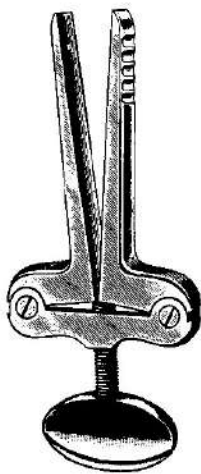
DOYEN-JANSEN (MOLT)  
EV49265-14 14 cm, 5 <sup>1</sup>/<sub>2</sub>"



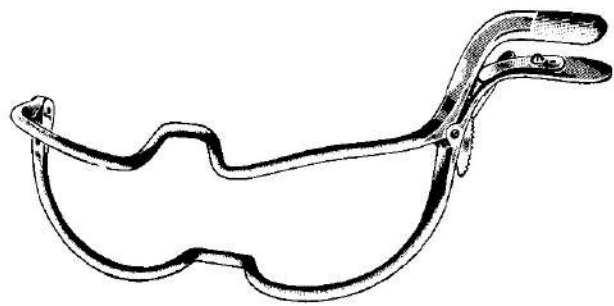
DENHART  
EV49267-12  
12 cm, 4 <sup>3</sup>/<sub>4</sub>"



ROSER-KOENIG  
EV49270-16 16 cm, 6 <sup>1</sup>/<sub>4</sub>"  
EV49270-19 19 cm, 7 <sup>1</sup>/<sub>2</sub>"



HEISTER  
EV49272-13  
13 cm, 5 <sup>1</sup>/<sub>8</sub>"



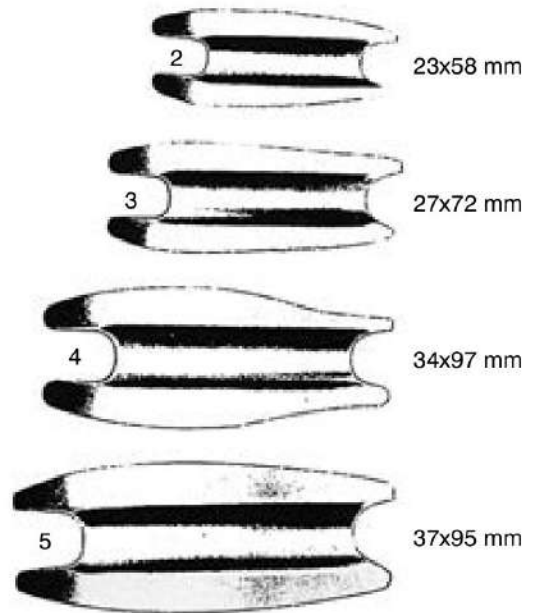
JENNINGS  
EV49274-09 9 cm, 3 <sup>1</sup>/<sub>2</sub>"  
EV49274-11 11 cm, 4 <sup>3</sup>/<sub>8</sub>"  
EV49274-13 13 cm, 5 <sup>1</sup>/<sub>8</sub>"  
EV49274-15 15 cm, 6"

Zungenspatel, Mundsperrer  
 Tongue depressor, Mouth Gags  
 Baja-lengua, Abre bocas  
 Abbassalingua, Apribocca



linke Seite  
 left side  
 izquierda  
 lato sinistro

rechte Seite  
 right side  
 derecha  
 lato destro



2 23x58 mm

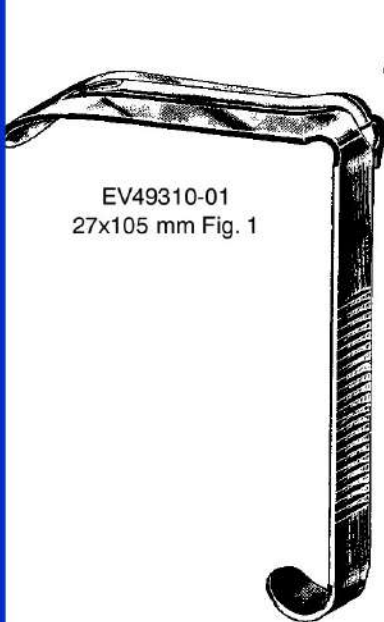
3 27x72 mm

4 34x97 mm

5 37x95 mm

RING

- |            |        |            |
|------------|--------|------------|
| EV49287-02 | Fig. 2 | EV49288-02 |
| EV49287-03 | Fig. 3 | EV49288-03 |
| EV49287-04 | Fig. 4 | EV49288-04 |
| EV49287-05 | Fig. 5 | EV49288-05 |



EV49310-01  
 27x105 mm Fig. 1

DAVIS-BOYLE  
 EV49310-00  
 compl.



EV49310-02  
 25x90 mm Fig. 2



EV49310-03  
 25x75 mm Fig. 3



EV49310-04  
 22x60 mm Fig. 4



EV49310-05  
 20x25 mm Fig. 5



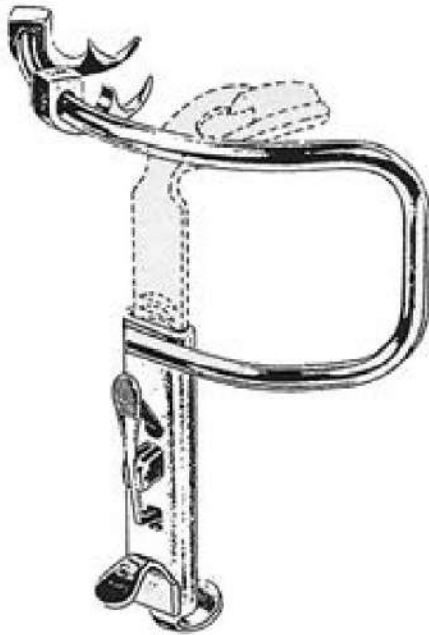
für Erwachsene  
 for adults  
 para adulto  
 per adulti

EV49310-10  
 Sperrer allein, links Gag  
 only, left Abre-boca suelta,  
 izquierda  
 Apribocca solo, sinistra

EV49310-12 Sperrer  
 allein, rechts Gag only,  
 right Abre-boca suelta,  
 derecha  
 Apribocca solo, destra

EV49310-08 Silikoneinlagen/Silicone pads in-  
 serto de silicona/inserto in silicone

Mundsperrer  
Mouth Gags  
Abre-Bocas  
Apribocca



EV49315-10  
Sperrer allein  
Gag only Abre-  
boca solo  
Apribocca solo



EV49315-01  
37 x 80 mm  
Fig. 1



EV49315-02  
32 x 75 mm  
Fig. 2



EV49315-03  
28 x 65 mm  
Fig. 3

**KILNER-DOUGHTY**

EV49315-00  
komplett  
complete  
completo

**EV49317-00 DINGMANN, complete**  
mit 3 auswechselbaren Zungendrücke,  
2 seitliche Wangenhaken und 2 Zahnhaken

with 3 interchangeable tongue depressors,  
2 rotating cheek holders  
2 movable tooth hooks and thread guide

con 3 baja lenguas intercambiables,  
2 valvas giratorias p. los labios,  
2 ganchos graduables

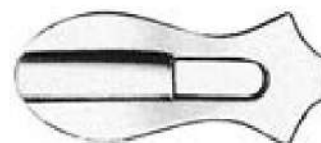
con 3 depressori intercambiabili,  
2 valve laterali rotative  
2 uncini a denti mobile



1 24x62 mm  
EV49317-01



2 28x65 mm  
EV49317-02



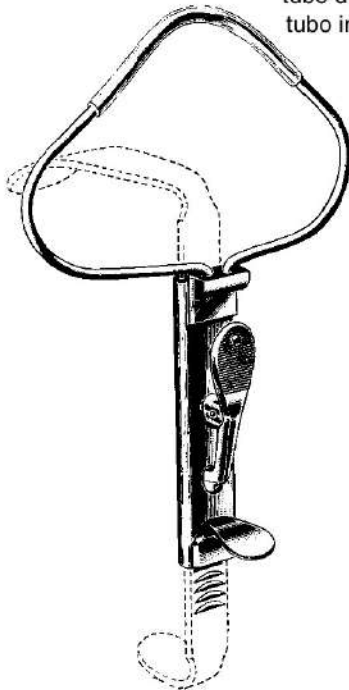
3 31x75 mm  
EV49317-03



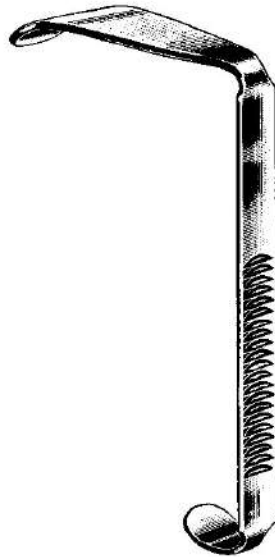
DINGMANN  
EV49317-10  
Sperrer allein, Gag only Abre-  
boca solo, Apribocca solo

Mundsperrer  
Mouth Gag  
Abre-bocas  
Apribocca

EV49320-20  
Silikon-Schlauch  
Silicon Tubing  
tubo de silicona  
tubo in silicone



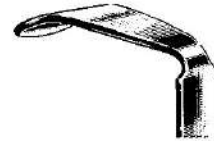
EV49320-10 McIVOR  
EV49320-00  
compl.



EV49320-01  
27x95 mm Fig. 1



EV49320-02  
22x85 mm Fig. 2



EV49320-03  
22x70 mm Fig. 3



DAVIS-MEYER  
EV49340-00

Zungenspatel  
Tongue blades  
Baja-lenguas  
Abbassalingua



EV49342-01 29 x 67 mm

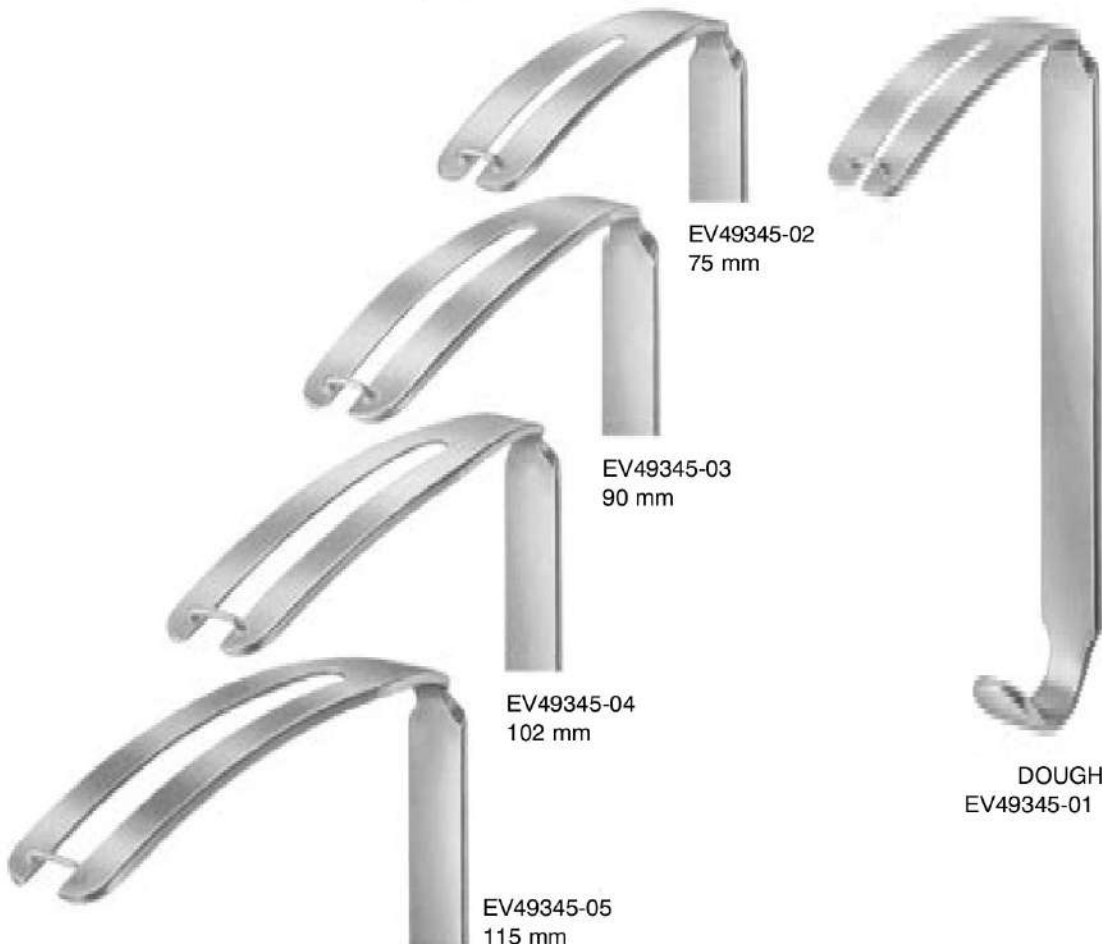
EV49342-02 33 x 75 mm

EV49342-03 38 x 85 mm

EV49342-04 40 x 92 mm

EV49342-05 46 x 100 mm

RUSSEL-DAVIS



EV49345-02  
75 mm

EV49345-03  
90 mm

EV49345-04  
102 mm

EV49345-05  
115 mm

DOUGHTY  
EV49345-01 65 mm



Mundkeil, Bruststütze, Repositionszange  
 Oral wedges, Chest support, Disimpaction forceps  
 Abrebooca, Soporte de pecho, Pinzas para reposiciones  
 Apribocca, Supporto per petto, Pinze per riposizione

Holz  
 wood  
 madera  
 legno



MAUNDER  
 EV49360-10



NEGUS  
 EV49400-01



links  
 left side  
 izquierda  
 lato sinistro

ROWE

EV49501-22 22,5 cm, 8.9"  
 EV49501-23 23,5 cm, 9 1/4"  
 EV49501-24 24,0 cm, 9 1/2"

Baby, baby, bebé, lattante  
 Kind, child, niño, bambino  
 Erwachs., adult, adulto



rechts  
 right side  
 derecha  
 lato destro

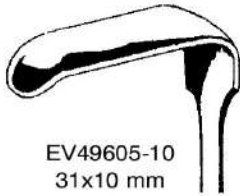
ROWE

EV49503-22 22,5 cm, 8.9"  
 EV49503-23 23,5 cm, 9 1/4"  
 EV49503-24 24,0 cm, 9 1/2"

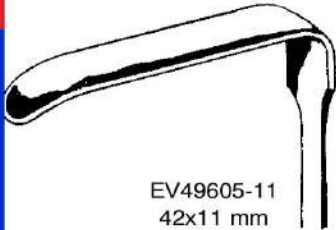
Wundhaken für Mund-Kiefer-Gesicht  
 Retractors for Mouth-, Jaw- and Face Surgery  
 Separadores para cirugía plástica  
 Divaricatori per chirurgia plastica



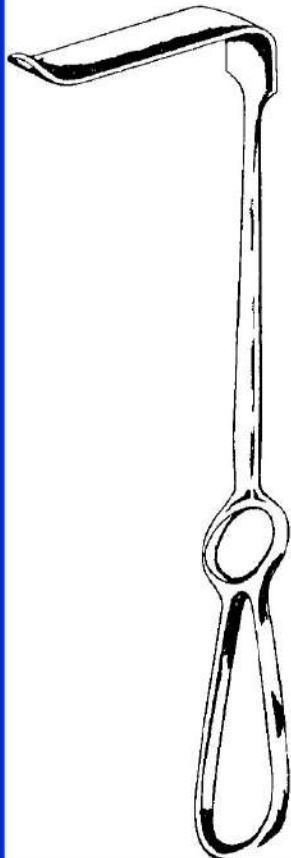
EV49605-07  
25x7 mm



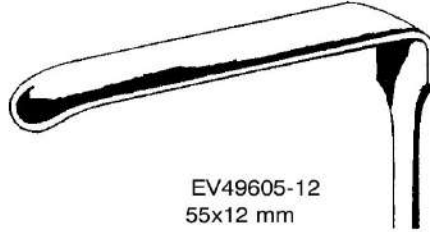
EV49605-10  
31x10 mm



EV49605-11  
42x11 mm



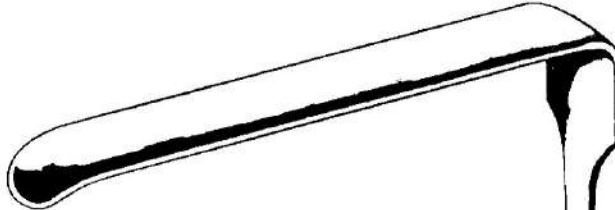
OBWEGESER  
 EV49610-12 -  
 EV49610-16 22 cm, 8 3/4"



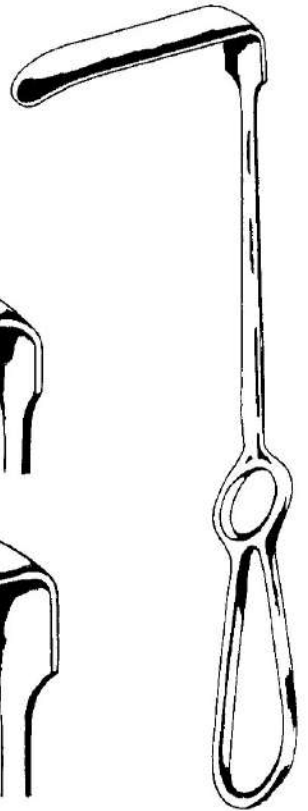
EV49605-12  
55x12 mm



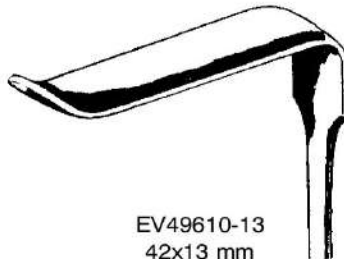
EV49605-14  
70x14 mm



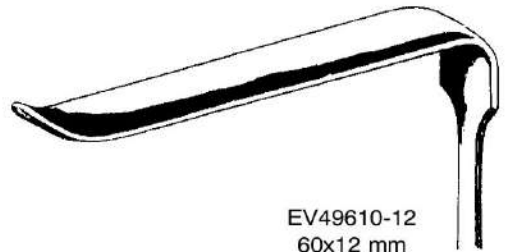
EV49605-16  
80x16 mm



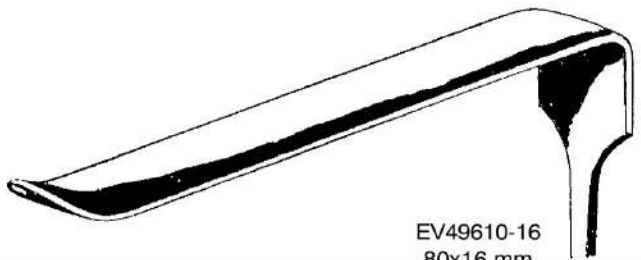
OBWEGESER EV49605-07  
 - EV49605-16 22 cm, 8 3/4"



EV49610-13  
42x13 mm

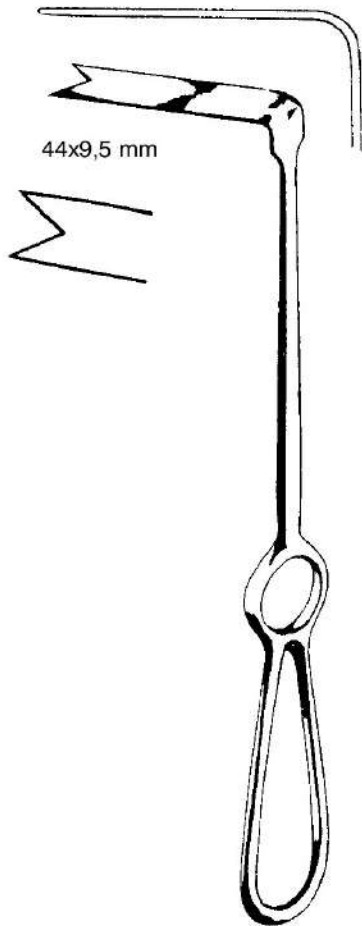


EV49610-12  
60x12 mm

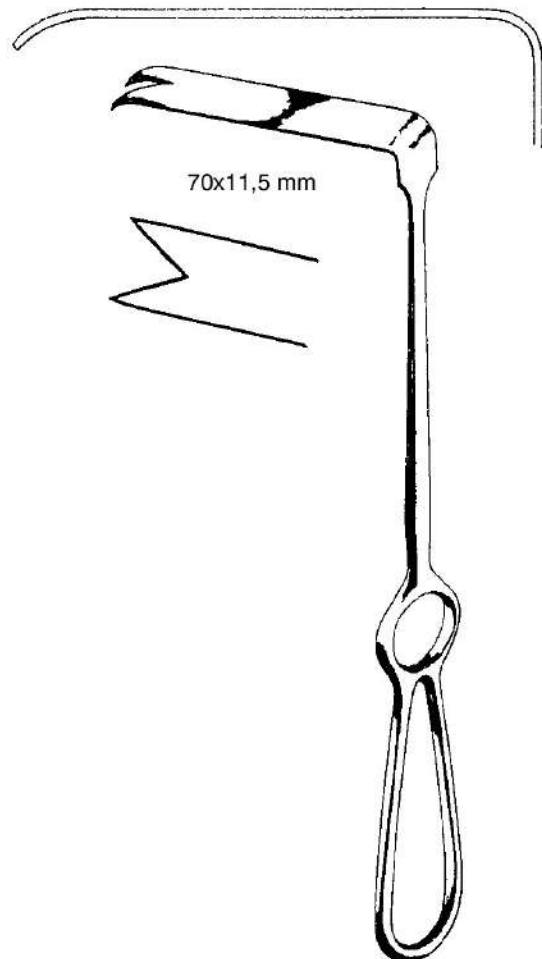


EV49610-16  
80x16 mm

Wundhaken für Mund-Kiefer-Gesicht  
Retractors for Mouth-, Jaw- and Face Surgery  
Separadores para cirugía plástica  
Divaricatori per chirurgia plastica

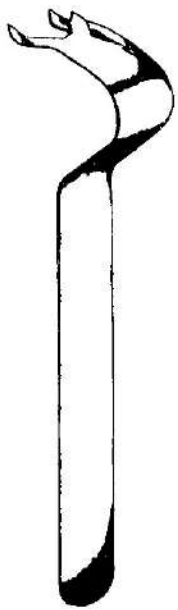


SPINA-NASALIS  
EV49613-10  
22 cm, 8 <sup>3</sup>/<sub>4</sub>"

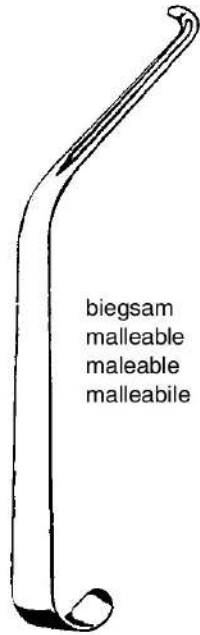


RAMUS  
EV49615-12  
22 cm, 8 <sup>3</sup>/<sub>4</sub>"

Wundhaken für Mund-Kiefer-Gesicht, Raspatorien  
 Retractors for Mouth-, Jaw- and Face Surgery, Periosteal Elevators  
 Separadores para cirugía plástica, Periostótomos  
 Divaricatori per chirurgia plastica, Periostotomi



OBWEGESER  
 EV49620-15  
 15,5 cm, 6"

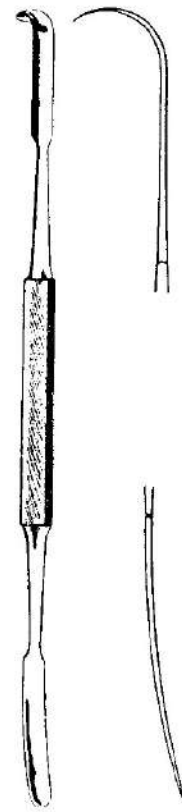


OBWEGESER  
 EV49623-16  
 16 cm, 6 1/4"

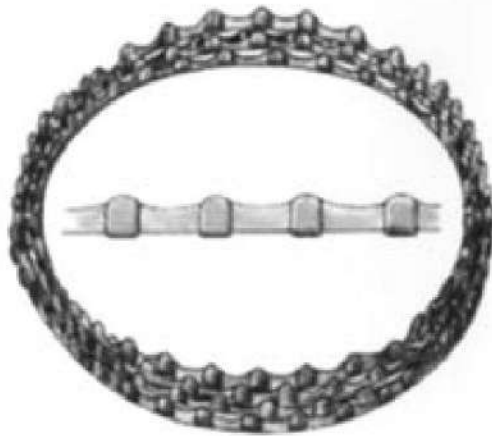
biegsam  
 malleable  
 maleable  
 malleabile



OBWEGESER  
 EV49627-01  
 21 cm, 8 1/4"

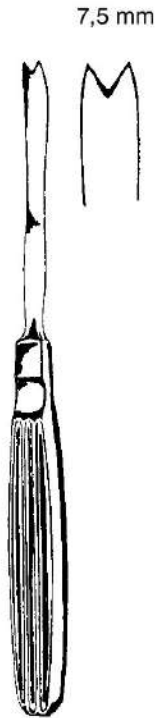


OBWEGESER  
 EV49630-02  
 20,5 cm, 8"



ERICH  
EV49631-00  
20,5 cm, 8"

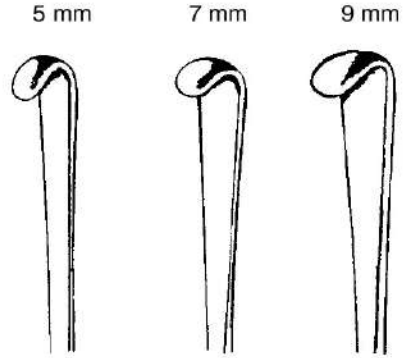
Raspatorien  
 Periosteal Elevators  
 Periostótomos  
 Periostotomi



OBWEGESER  
 EV49635-18  
 17,5 cm, 7"



OBWEGESER  
 EV49640-05 -  
 EV49640-09 20 cm, 8"



EV49640-05 EV49640-07 EV49640-09



OBWEGESER  
 EV49650-06 -  
 EV49650-11 17,5 cm, 7"



EV49650-06



EV49650-07



EV49650-09



EV49650-11

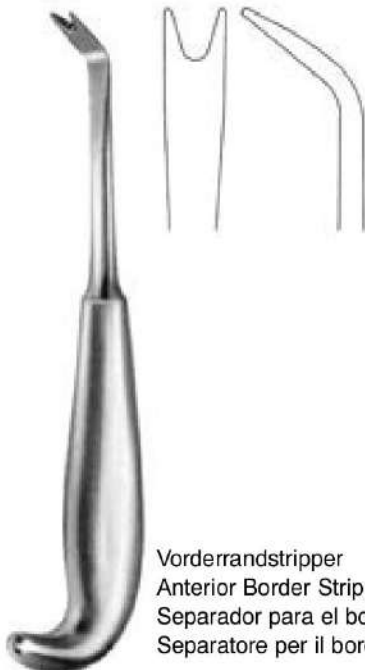
Elevator, Osteotom, Ahle  
 Elevator, Osteotome, Awls  
 Elevadores, Osteotomos, Agujas  
 Elevatori, Osteotomo, Aghi



DINGMAN  
 EV49660-18  
 18 cm, 7"



OBWEGESER  
 EV49665-24  
 23,5 cm, 9 1/4"



Vorderrandstripper  
 Anterior Border Stripper  
 Separador para el borde anterior  
 Separatore per il bordo anteriore

HARGIS  
 EV49670-19  
 19 cm, 7 1/2"



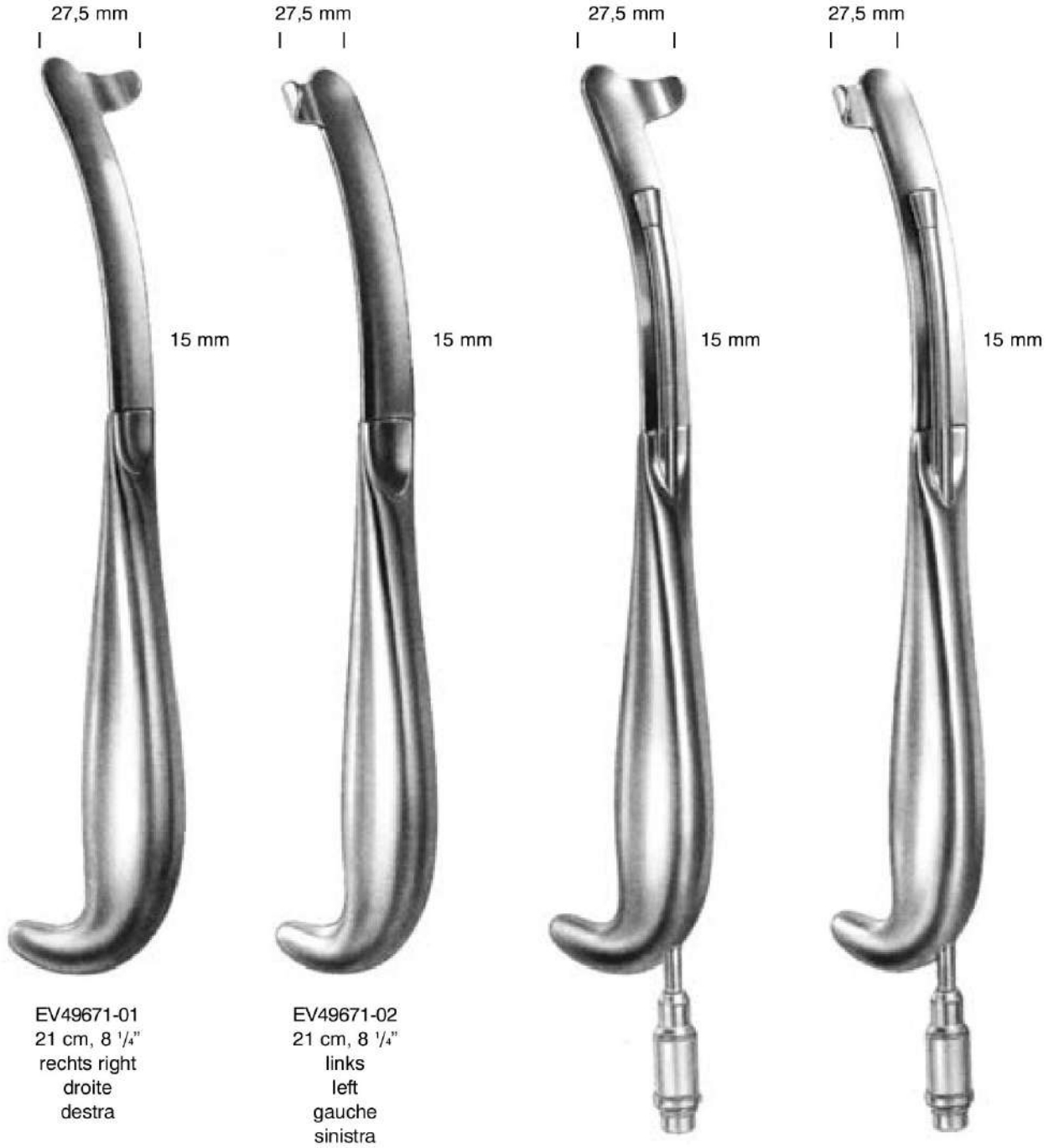
Spreizzange  
 Ramus Separator  
 Pinza para separar la rama  
 Pinza per separare il ramo

SMITH  
 EV49670-20  
 23,5 cm, 9 1/4"



OBWEGESER  
 EV49670-23  
 23 cm, 9"

Intraorale Retraktoren  
 Intra Oral Retractors  
 Separadores intra orales  
 Retrattori intraorali



EV49671-01  
 21 cm, 8 1/4"  
 rechts right  
 droite  
 destra

EV49671-02  
 21 cm, 8 1/4"  
 links  
 left  
 gauche  
 sinistra

EV49671-01 CL  
 24,5 cm, 9 3/4"  
 rechts  
 right  
 droite  
 destra

EV49671-02 CL  
 24,5 cm, 9 3/4"  
 links left  
 gauche  
 sinistra



Raspatorien  
 Periosteal Elevators  
 Legras  
 Elevatori per periostio



HARGIS  
 23 cm, 9"



EV49673-01  
 6,5 mm  
 rechts right  
 derecha  
 destra

EV49673-02  
 9 mm  
 rechts right  
 derecha  
 destra



EV49673-03  
 6,5 mm  
 links left  
 izquierda  
 sinistra

EV49673-04  
 9 mm links  
 left  
 izquierda  
 sinistra



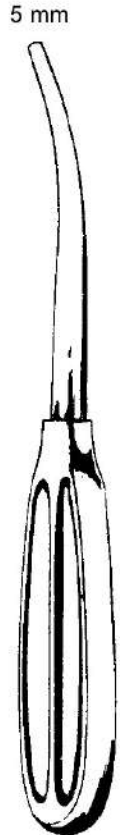
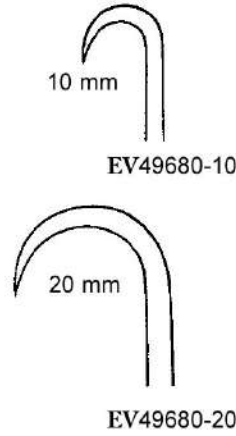
Ahle, Haken, Elevator  
 Auls, Retractors for Mouth-, Jaw- and Face Surgery  
 Agujas, Separadores para cirugía plástica  
 Aghi, Divaricatori per chirurgia plastica



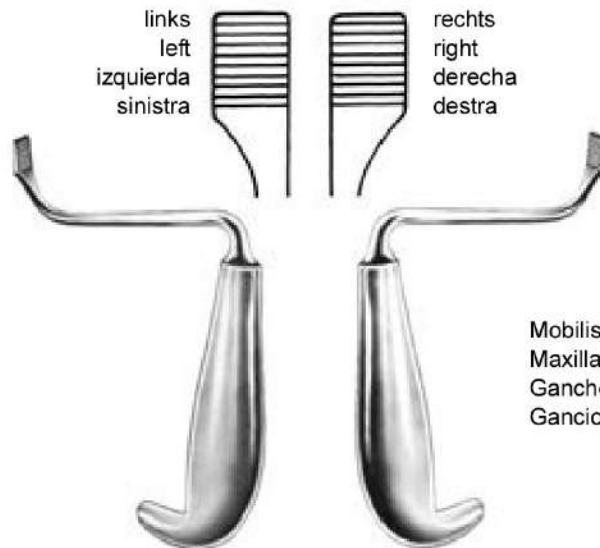
OBWEGESER  
 EV49675-18  
 18 cm, 7"



19 cm, 7 1/2"



5 mm  
 DINGMAN  
 EV49685-21  
 21 cm, 8 1/4"



TESSIER  
 EV49691-15 15 cm, 6"

TESSIER  
 EV49692-15 15 cm, 6"

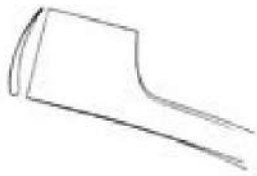
Mobilisierhaken  
 Maxillary Mobilizer  
 Gancho para movilización  
 Gancio per mobilizzare



EV49694-25  
25 cm, 9 <sup>3</sup>/<sub>4</sub>"  
12,5 / 27 mm

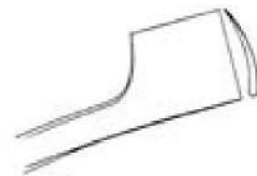
EV49694-25 CL  
28 cm, 11" 12,5 /  
27 mm

Sagittalspreizer  
Sagittal Split Separators  
Separadores sagitales  
Separatori sagittali



rechts  
right  
derecha  
destra

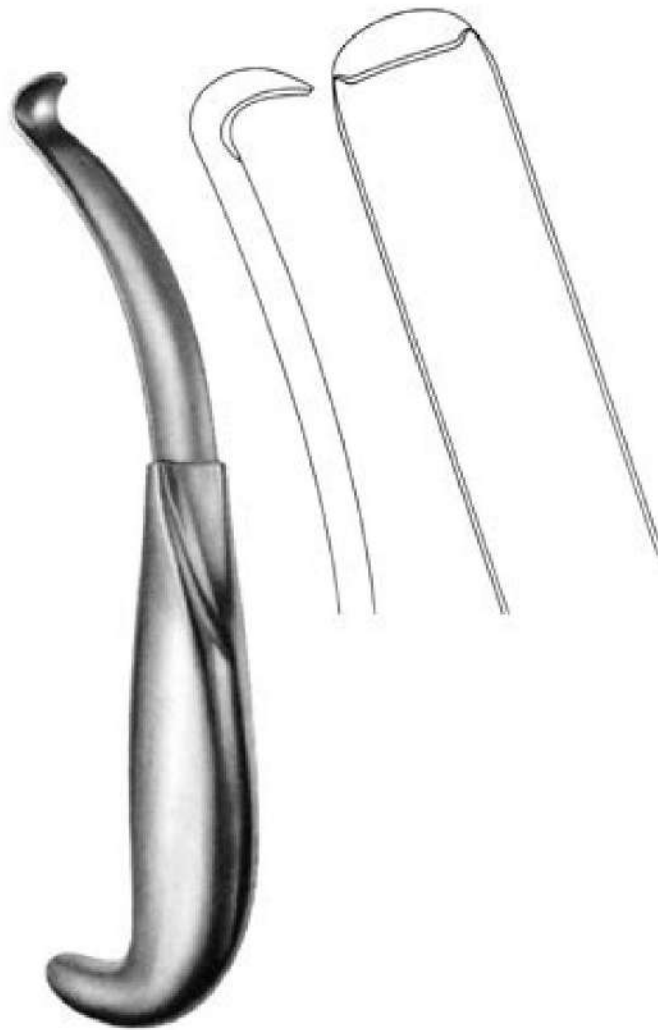
SMITH  
EV49695-01  
18,5 cm, 7 1/4"  
9 mm



links  
left  
izquierda  
sinistra

SMITH  
EV49695-02  
18,5 cm, 7 1/4"  
9 mm

Unterkieferkörperhaken  
Mandibular Body Retractor  
Separador para el cuerpo mandibular  
Separatore per il corpo mandibolare



HARGIS  
EV49696-18  
18 cm, 7"

Osteotome  
Osteotome  
Osteótomos  
Osteotomi



EV49700-01  
21,5 cm, 8 1/2"



EV49700-02  
21,5 cm, 8 1/2"



Blattosteotom  
Blade Osteotomes  
Osteótomos de hoja  
Osteotomo a lama



OBWEGESER  
22 cm, 8 <sup>3</sup>/<sub>4</sub>"



EV49705-08  
8 mm



EV49705-12  
12 mm



EV49705-16  
16 mm



EV49705-20  
20 mm



Osteotome  
 Osteotome  
 Osteótomos  
 Osteotomi



EV49710-04  
 4x1,2 mm



EV49710-06  
 6x1,2 mm



EV49710-08  
 8x1,2 mm

EPKER  
 18 cm, 7"



EV49711-04  
 4x1,2 mm



EV49711-06  
 6x1,2 mm

EPKER  
 18 cm, 7"



EV49713-06  
 6x1,2 mm



EV49713-08  
 8x1,2 mm

EPKER  
 18 cm, 7"







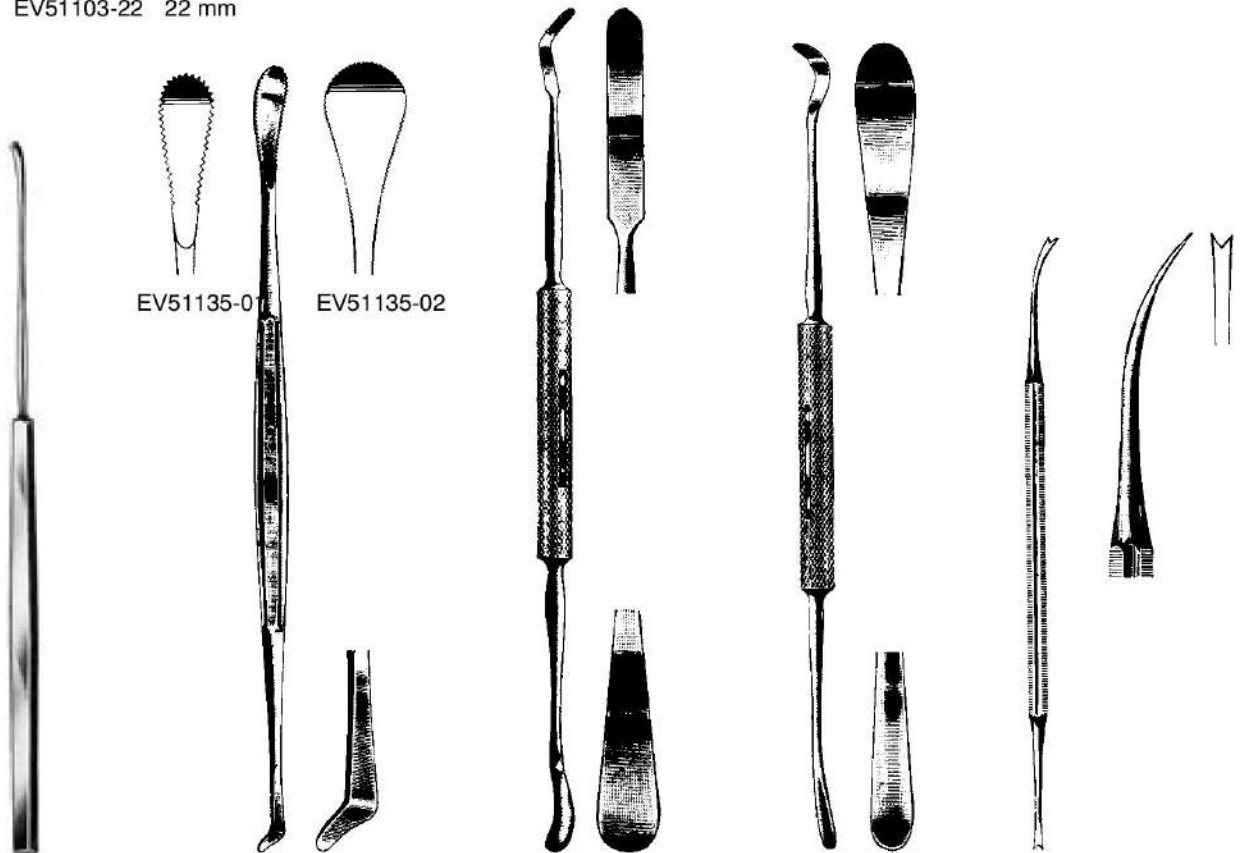
LOVE 15 cm, 6"  
 EV51103-18 18 mm  
 EV51103-20 20 mm  
 EV51103-22 22 mm

HOFER  
 EV51109-24  
 24 cm, 9 1/2"

NAGER  
 EV51111-23  
 23 cm, 9"

HURD  
 EV51131-22  
 22 cm, 8 1/4"

LOPEZ-REINKE  
 EV51133-23  
 23 cm, 9"



EV51135-01

EV51135-02

YANKAUER  
 EV51134-21  
 21 cm, 8 1/4"

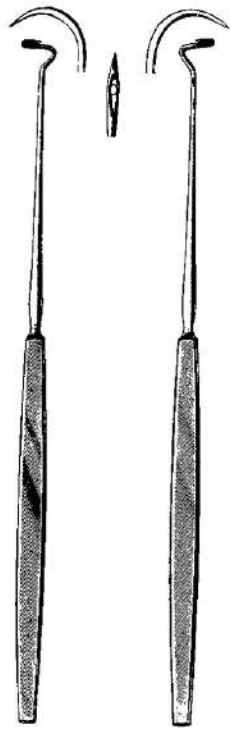
HENKE  
 23 cm, 9"

CARPENTER  
 EV51139-25  
 25 cm, 10"

CARPENTER  
 EV51143-24  
 24 cm, 9 1/2"

LUNIATSCHEK  
 EV51151-19  
 19 cm, 7 1/2"

Tonsillen-Nadeln, Tonsillen-Messer  
 Tonsil Needles, Tonsil-Knives  
 Agujas para suturas de amígdalas, Bisturios para amígdalas  
 Aghi per tonsille, Coltelli per tonsille



DUPUY-WEISS  
 EV51165-22 EV51167-22  
 22 cm, 8 3/4"



CLAUS  
 EV51168-23  
 23 cm, 9"



CLAUS-EICKEN  
 EV51169-23  
 23 cm, 9"



NAGER  
 EV51170-24  
 24 cm, 9 1/2"



FISHER  
 EV51171-22  
 22,5 , 9"



ABRAHAM  
 EV51172-19  
 19 cm, 7 1/2"



ABRAHAM  
 EV51173-21  
 21 cm, 8 1/4"



CANFIELD  
 EV51174-21  
 21 cm, 8 1/4"



BRUENINGS  
 EV51177-23  
 23 cm, 9"

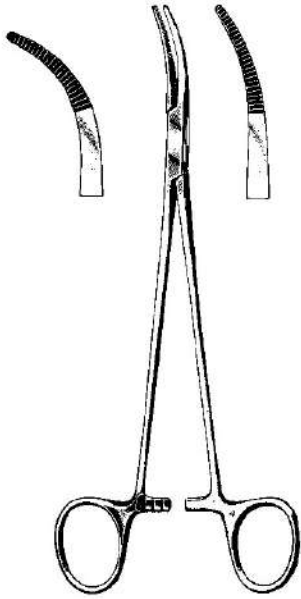


DOUGLAS  
 EV51178-21  
 21 cm, 8 1/4"

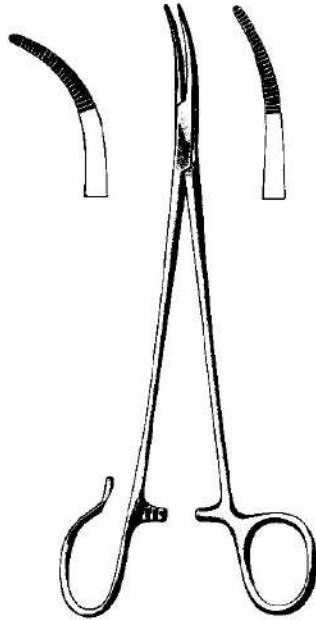


DOUGLAS  
 EV51179-17  
 17 cm, 6 3/4"

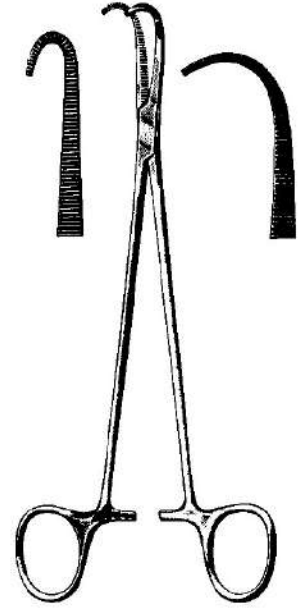
Tonsillenzange  
Tonsil Seizing Forceps  
Pinzas para coger las amígdalas  
Pinze per tonsille



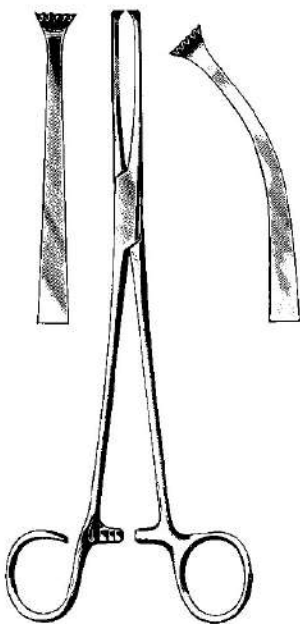
19 cm, 7 1/2"  
SAWTELL SCHNIDT  
EV51181-19 EV51183-19



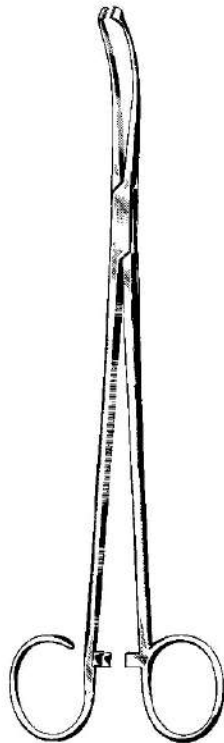
19 cm, 7 1/2"  
SAWTELL SCHNIDT  
EV51185-19 EV51187-19



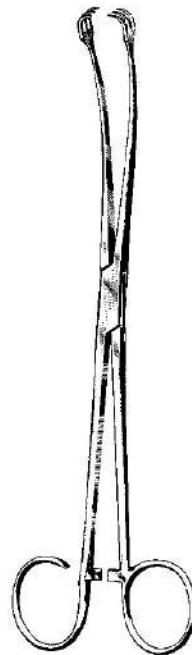
19 cm, 7 1/2"  
NEGUS NEGUS  
EV51191-19 EV51193-19



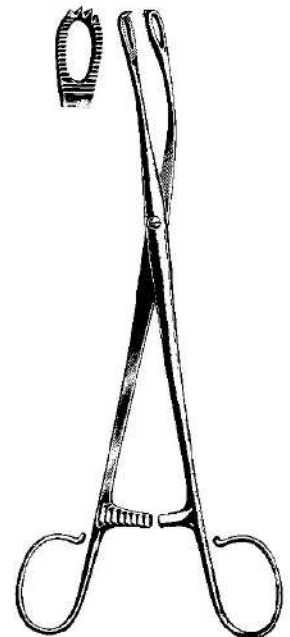
19 cm, 7 1/2"  
COLVER  
EV51202-19 EV51203-19



WHITE  
EV51205-18 18 cm, 7"  
EV51205-23 23 cm, 9"



BALLENGER  
EV51207-21  
21,5 cm, 8 1/2"

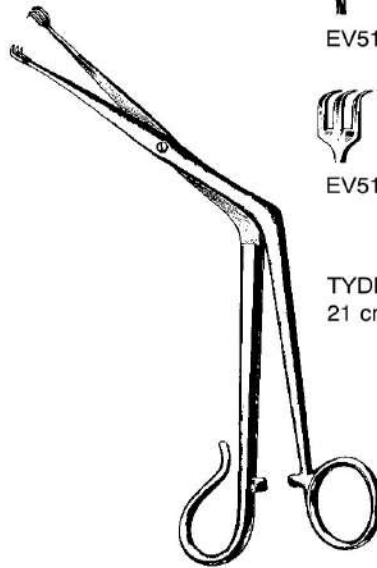


BLOHMKE  
EV51209-20  
20 cm, 8"

Tonsillen-Zangen u. -Pinzetten, Tonsillen-Kompressoren, Tonsillen-Schnürer  
 Tonsil-Forceps, Tonsil-Snares  
 Pinzas, Compresores para amígdalas, Cierra-nudos para amígdalas  
 Pinze, Compresori per tonsille, Serranodi per tonsille



ABRAHAM  
 EV51210-20  
 20 cm, 8"

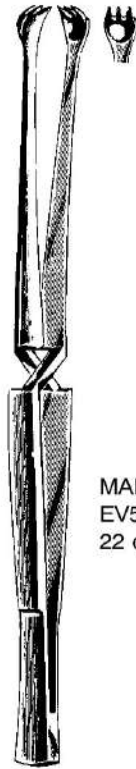


EV51211-21



EV51213-21

TYDING  
 21 cm, 8 1/4"



MARSCHIK  
 EV51219-22  
 22 cm, 8 3/4"



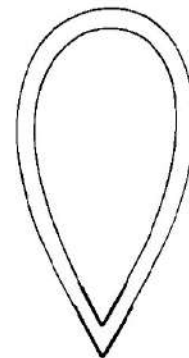
EVES  
 EV51250-28  
 28 cm, 11"



EVES  
 EV51252-28  
 28 cm, 11"



BRUENINGS  
 EV51256-28  
 28 cm, 11"

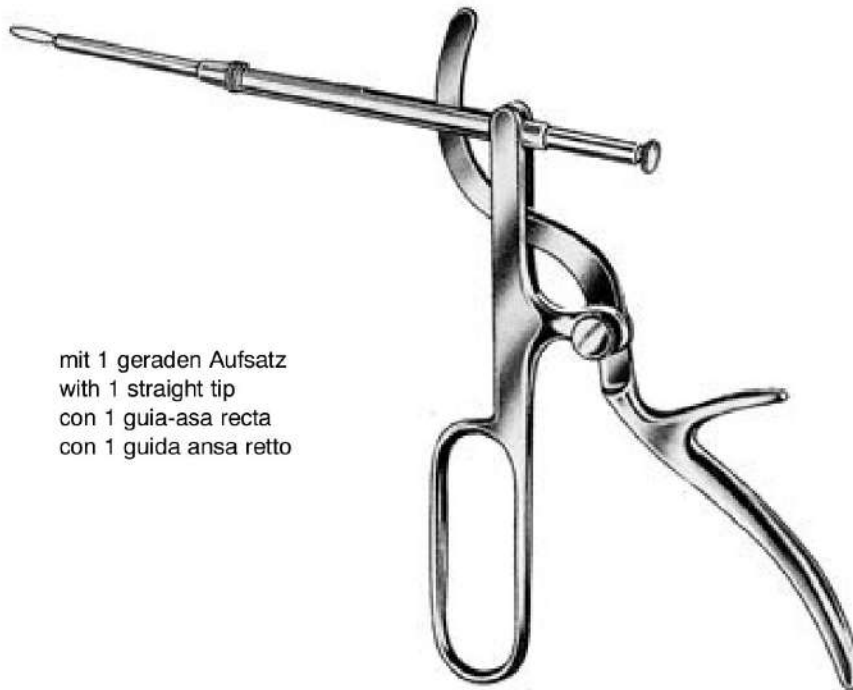


EV51257-40 40 mm  
 EV51257-50 50 mm  
 Pack of 100 pcs



EV51259-03 0,3 mm  
 EV51259-04 0,4 mm  
 EV51259-05 0,5 mm  
 Pack of 12 pcs

Tonsillotom  
Tonsillectomes  
Amigdalótomos  
Tonsillotomi



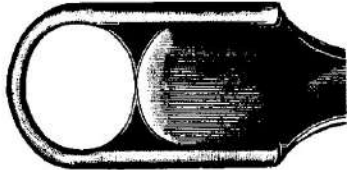
mit 1 geraden Aufsatz  
with 1 straight tip  
con 1 guida-asa recta  
con 1 guida ansa retto

TYDING  
EV51260-00

Tonsillotom, Spritzen, Septum Nadeln  
 Tonsillectomes, Syringes, Septum needles  
 Amigdalótomos, Jeringas, Septum aguja  
 Tonsillotomi, Siringhe, Septum aghi

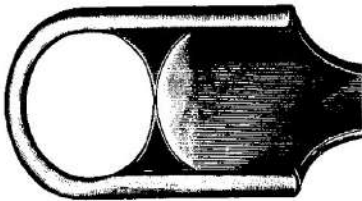
Aufsatz allein  
 blade only  
 hoja sola  
 lama sola

EV51270-01



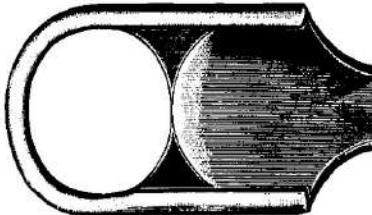
1

EV51270-02



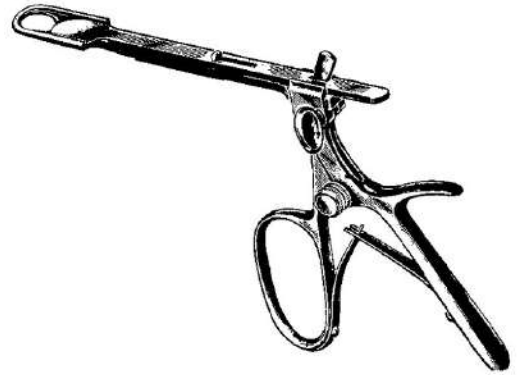
2

EV51270-03

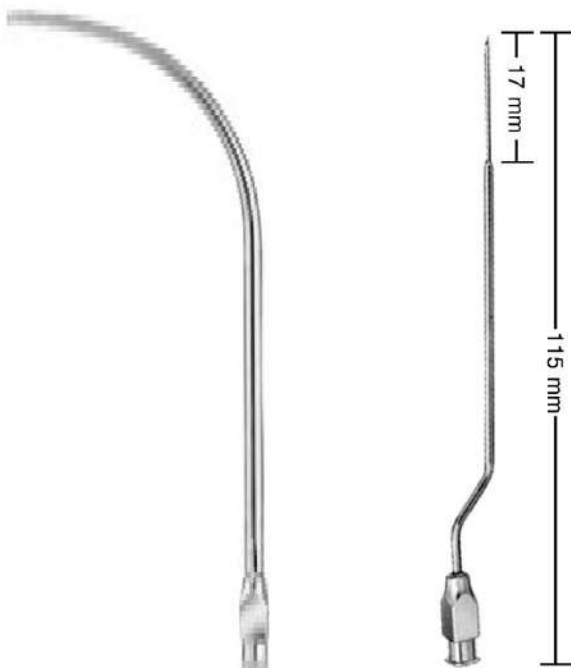


3

51270-04  
 Handgriff allein  
 Handle only  
 mango para  
 manipolo solo

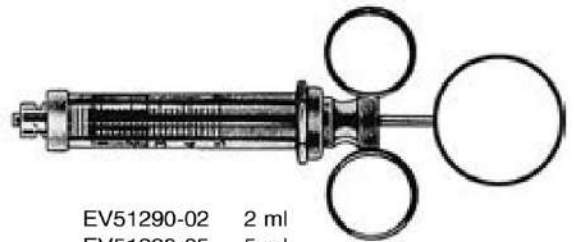


SLUDER-BALLENGER  
 EV51270-00  
 mit 3 Aufsätzen  
 with 3 blades  
 con 3 hojas  
 con 3 lame



EV51291-00  
 2,5 mm Ø

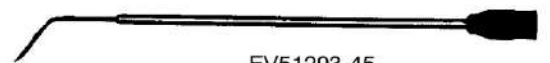
EV51293-00  
 0,8 mm Ø



EV51290-02 2 ml  
 EV51290-05 5 ml  
 EV51290-10 10 ml  
 EV51290-20 20 ml



EV51292-00



EV51293-45  
 45°



EV51293-90  
 90°

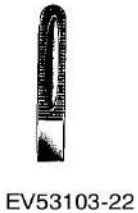
Septum-Schere, Kehlkopfpolypenzangen, Deckelhalter  
 Septum-Scissors, Laryngeal Polypus Forceps, Epiglottis Retractor  
 Tijeras para septo, Pinzas para pólipos laríngeos, Depresor para epiglottis  
 Forbice per il setto nasale, Pinze per polipi laringei, Depressore per epiglottide



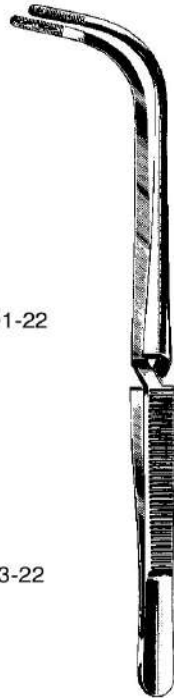
KILLIAN  
 EV53102-20  
 20 cm, 8"



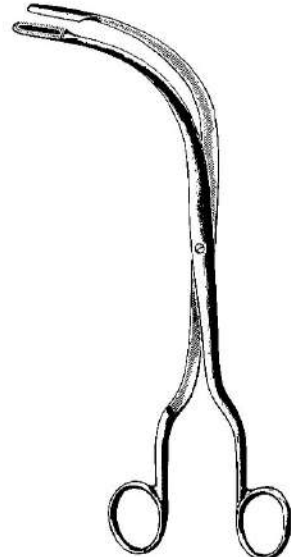
EV53101-22



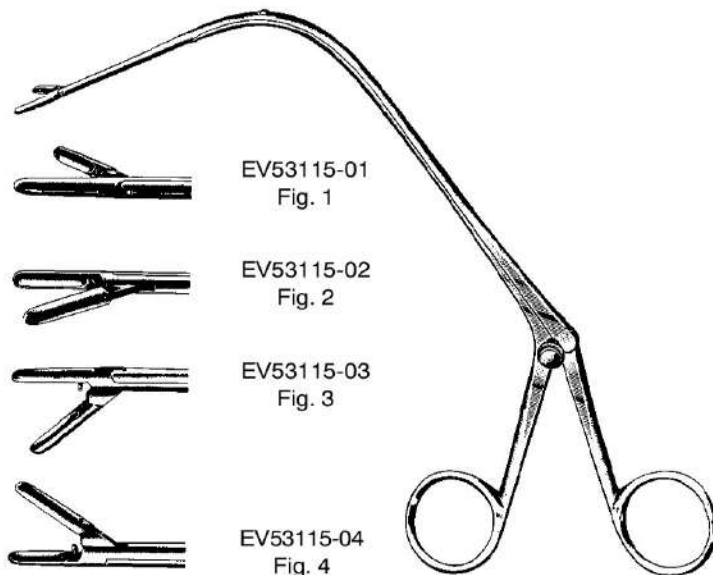
EV53103-22



JACKSON EV53101-22 -  
 EV53103-22 22 cm, 8 3/4"



FRAENKEL  
 EV53111-18  
 18 cm, 7"



EV53115-01  
 Fig. 1  
 EV53115-02  
 Fig. 2  
 EV53115-03  
 Fig. 3  
 EV53115-04  
 Fig. 4

JURASZ  
 EV53115-01 - EV53115-04  
 23 cm, 9"



REICHERT  
 EV53121-24  
 24 cm, 9 1/2"

Universalgriffe, Verlängerungsrohre, Aufsätze  
 Universal Handles, Interchangeable Tips, Tubes  
 Mangos universales y Tubos de extension, Puntas  
 Manici universali e Tubi di prolungamento, Terminale laringeo



BRUENINGS  
EV53131-20  
20 cm, 8"



HUBER  
EV53130-00

|            |                |            |                |
|------------|----------------|------------|----------------|
| BRUENINGS  |                |            |                |
| EV53132-20 | 20 cm, 8"      | EV53132-50 | 50 cm, 19 3/4" |
| EV53132-30 | 30 cm, 11 3/4" | EV53132-60 | 60 cm, 23 1/2" |
| EV53132-40 | 40 cm, 15 3/4" |            |                |



FRAENKEL  
EV53150-00



SEIFERT  
EV53152-00



FRAENKEL  
EV53154-00



SCHEINMANN  
EV53155-00



SCHEINMANN  
EV53157-00



BRUENINGS EV53158-02 -  
EV53158-03

- EV53158-02
- EV53158-03

- EV53160-02

- EV53160-03



BRUENINGS EV53160-02 -  
EV53160-03



LANGE  
EV53162-00

- ⊕ 53164-01

- ⊕ 53164-02



KRAUSE EV53164-01 -  
EV53164-02



KRAUSE  
EV53166-00



SCHUMACHER  
EV53170-00



BARACANI  
EV53175-00

- ⊕ EV53177-01

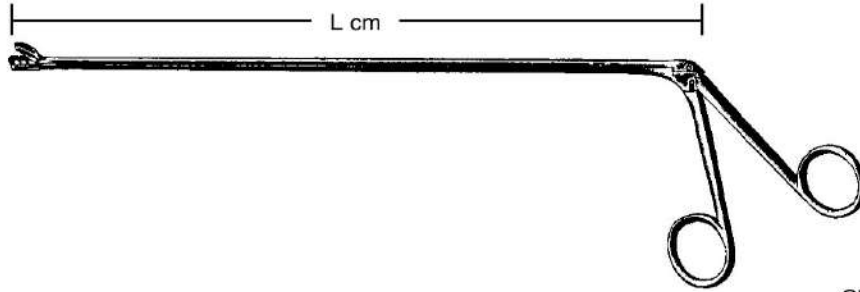
- ⊕ EV53177-02



CORDES EV53177-01 -  
EV53177-02



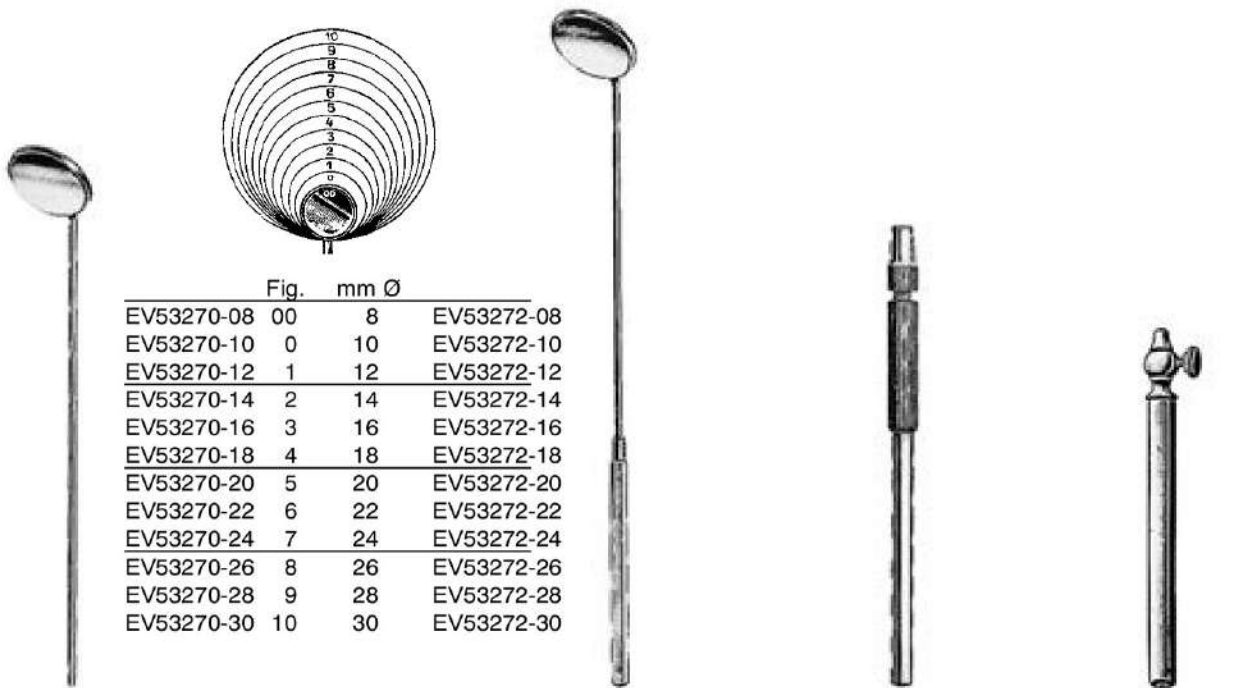
Broncho-Oesophagoskopiezangen, Kehlkopfspiegel, Griffe  
 Broncho-Esophagoscopy Forceps, Laryngeal Mirrors, Handles  
 Pinzas para bronco-esofagoscopia, Espejos laringeos, Mangos  
 Pinze per bronco-esofagoscopia, Specchi laringei, Manici



CHEVALIER-JACKSON  
 EV53230-01 - EV53260-08



| cm         | Fig. 1     | Fig. 2     | Fig. 3     | Fig. 4     | Fig. 5     | Fig. 6     | Fig. 7     | Fig. 8     |
|------------|------------|------------|------------|------------|------------|------------|------------|------------|
| 30/11 3/4" | EV53230-01 | EV53230-02 | EV53230-03 | EV53230-04 | EV53230-05 | EV53230-06 | EV53230-07 | EV53230-08 |
| 40/15 3/4" | EV53240-01 | EV53240-02 | EV53240-03 | EV53240-04 | EV53240-05 | EV53240-06 | EV53240-07 | EV53240-08 |
| 50/19 3/4" | EV53250-01 | EV53250-02 | EV53250-03 | EV53250-04 | EV53250-05 | EV53250-06 | EV53250-07 | EV53250-08 |
| 60/23 1/2" | EV53260-01 | EV53260-02 | EV53260-03 | EV53260-04 | EV53260-05 | EV53260-06 | EV53260-07 | EV53260-08 |



| Fig.       | mm Ø |               |
|------------|------|---------------|
| EV53270-08 | 00   | 8 EV53272-08  |
| EV53270-10 | 0    | 10 EV53272-10 |
| EV53270-12 | 1    | 12 EV53272-12 |
| EV53270-14 | 2    | 14 EV53272-14 |
| EV53270-16 | 3    | 16 EV53272-16 |
| EV53270-18 | 4    | 18 EV53272-18 |
| EV53270-20 | 5    | 20 EV53272-20 |
| EV53270-22 | 6    | 22 EV53272-22 |
| EV53270-24 | 7    | 24 EV53272-24 |
| EV53270-26 | 8    | 26 EV53272-26 |
| EV53270-28 | 9    | 28 EV53272-28 |
| EV53270-30 | 10   | 30 EV53272-30 |

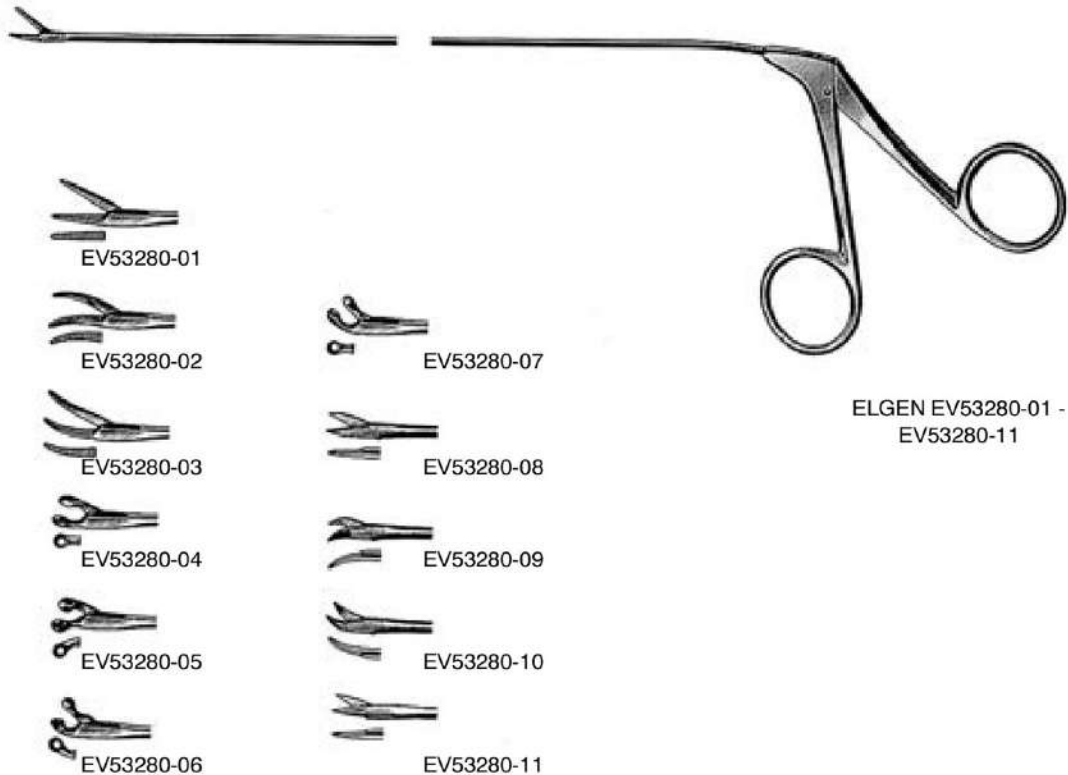
EV53270-08 - EV53270-30

EV53272-08 - EV53272-30

EV53274-12

EV53276-10

Mikro-Rohrschaftzangen  
 Micro Laryngeal Forceps  
 Pinzas para la micro-cirugía de la laringe  
 Pinze ad asta tubolare per microchirurgia



ELGEN EV53280-01 -  
EV53280-11

**ELGEN Mikro-Rohrschaftzangen 22 cm (8 3/4")**

- EV53280-01 gerieftes Maul, gerade 1,5 x 10 mm
- EV53280-02 gerieftes Maul, links gebogen 1,5 x 8,5 mm
- EV53280-03 gerieftes Maul, rechts gebogen 1,5 x 8,5 mm
- EV53280-04 Löffelmaul, gerade 2,5 mm
- EV53280-05 Löffelmaul, links abgewinkelt 2,5 mm
- EV53280-06 Löffelmaul, rechts abgewinkelt 2,5 mm
- EV53280-07 Löffelmaul, aufwärts abgewinkelt 2,5 mm
- EV53280-08 Schere, gerade, vertikal
- EV53280-09 Schere, links gebogen
- EV53280-10 Schere, rechts gebogen
- EV53280-11 Schere, horizontal schneidend, gerade

**ELGEN Pinza microlaringea 22 cm (8 3/4")**

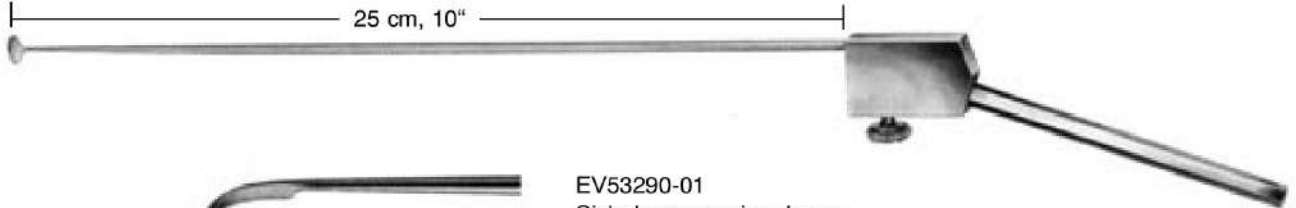
- EV53280-01 boca estriada recta 1,5 x 10 mm
- EV53280-02 boca estriada curva a la izquierda 1,5 x 8,5 mm
- EV53280-03 boca estriada curva a la derecha 1,5 x 8,5 mm
- EV53280-04 boca redonda cortante recta 2,5 mm Ø
- EV53280-05 boca redonda cortante angulada al la izquierda 2,5 mm Ø
- EV53280-06 boca redonda cortante angulada a la derecha 2,5 mm Ø
- EV53280-07 boca redonda cortante angulada hacia arriba 2,5 mm Ø
- EV53280-08 Tijera recta corte vertical
- EV53280-09 Tijera curva a la izquierda
- EV53280-10 Tijera curva a la derecha
- EV53280-11 Tijera recta corte horizontal

**ELGEN Micro-Laryngeal Forceps 22 cm (8 3/4")**

- EV53280-01 Grasping tip, straight, serrated, 1,5 x 10 mm
- EV53280-02 Grasping tip, curved to left, serrated, 1,5 x 8,5 mm
- EV53280-03 Grasping tip, curved to right, serrated, 1,5 x 8,5 mm
- EV53280-04 Cup forceps, straight, 2,5 mm
- EV53280-05 Cup forceps, angled to left, 2,5 mm
- EV53280-06 Cup forceps, angled to right, 2,5 mm
- EV53280-07 Cup forceps, angled up, 2,5 mm
- EV53280-08 Scissors, straight, vertical
- EV53280-09 Scissors, curved to left
- EV53280-10 Scissors, curved to right
- EV53280-11 Scissors, straight, horizontal

**ELGEN Pinze ad asta tubolare per microchirurgia 22 cm (8 3/4")**

- EV53280-01 morsi zigrinati, retti, 1,5 x 10 mm
- EV53280-02 morsi zigrinati, curvi a sinistra, 1,5 x 8,5 mm
- EV53280-03 morsi zigrinati, curvi a destra, 1,5 x 8,5 mm
- EV53280-04 morsi a forma di cucchiaio rotondo retto, 2,5 mm
- EV53280-05 morsi a forma di cucchiaio rotondo angolati a sinistra, 2,5 mm
- EV53280-06 morsi a forma di cucchiaio rotondo angolati a destra, 2,5 mm
- EV53280-07 morsi a forma di cucchiaio rotondo angolati in alto, 2,5 mm
- EV53280-08 forbici, rette, taglio verticale
- EV53280-09 forbici, curve a sinistra 53280-10
- EV53280-10 forbici, curve a destra 53280-11
- EV53280-11 forbici, rette, taglio orizzontale



EV53290-01  
 Sichelmesser micro-laryngeal sickle microlaringeo cuchillo de hoz Coltello falcato



EV53290-02  
 Schälmesser, quer, oval micro-laryngeal separador oval, horizontal microlaringeo separador ovalado, horizontal Seperatore ovale verticale



EV53290-03  
 Schälmesser, längs, oval micro-laryngeal separador oval, vertical microlaringeo separador ovalado, vertical Seperatore ovale orizzontale



EV53290-04  
 Schälmesser, 45° abgewinkelt micro-laryngeal round cutting knife, 45° angled microlaringeo cuchillo para cortes redondos, 45° angulado Seperatore angolato 45°



EV53290-05  
 Häkchen, 90° gebogen stumpf micro-laryngeal hook 90° angled, blunt microlaringeo ganchito 90° angulado, romo Uncino angolato 90° smusso

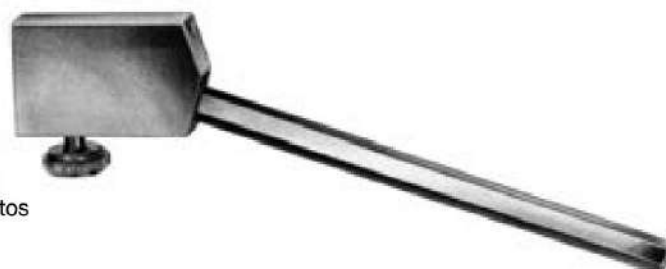


EV53290-06  
 Häkchen, 30° retrograd gebogen micro-laryngeal probe, 30° backwards curved blunt with button microlaringeo ganchito, 30° curvo retrogrado Uncino angolato retrogrado 30°

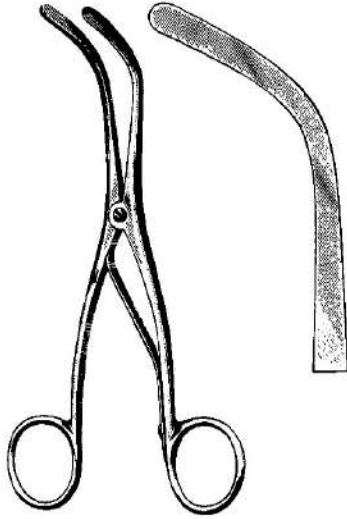


EV53290-07  
 Fadengabel micro-laryngeal ligatore adjuster microlaringeo horquilla de hilos Forchetta da sutura

EV53290-08  
 Handgriff für Stabinstrumente  
 Handle for microlaryngeal instruments  
 Mango para microlaringeos instrumentos  
 Manico per strumenti microlaringei

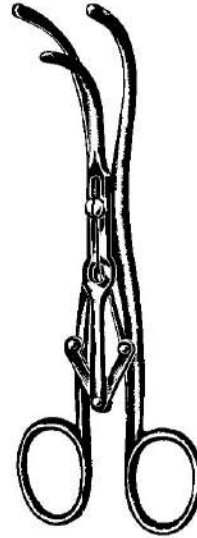


Tracheal Dilatatoren, Trachealhaken, Tracheal-Wundspreizer  
 Trachea Dilators, Trachea hooks, Tracheal Retractors  
 Dilatadores para la tráquea, Ganchos para traqueotomía, Retractor traqueal  
 Dilatatori per tracheotomia, Ganci per tracheotomia, Divaricatori tracheali



TROUSSEAU-BABY  
 EV55111-13 13 cm, 5 1/8"

TROUSSEAU EV55111-14  
 14 cm, 5 1/2"



LABORDE  
 EV55113-14  
 14 cm, 5 1/2"



BOSE  
 EV55115-07  
 7 cm, 2 3/4"

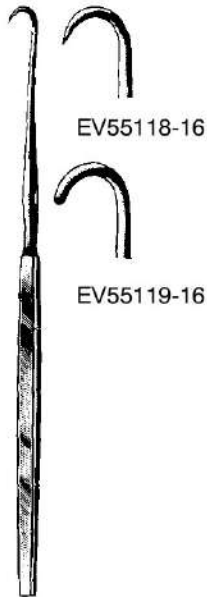


JACKSON  
 EV55116-15  
 15 cm, 6"

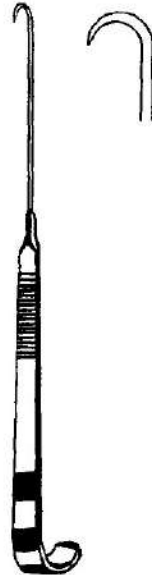


JACKSON  
 EV55117-17  
 17 cm, 6 3/4"

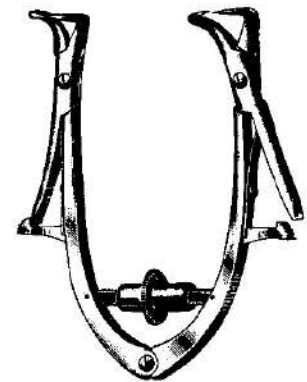
Trachealhaken, Kanüle  
 Trachea Hooks, Tubes  
 Ganchos para traqueotomía, Cánula  
 Ganci per tracheotomia, Cannule



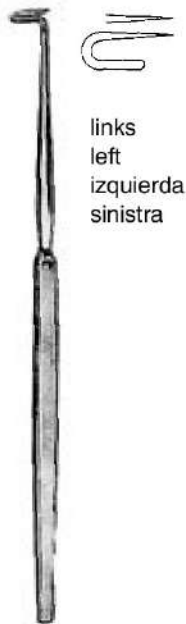
ITerson EV55118-16 -  
 EV55119-16 16 cm, 6 1/4"



NEWS  
 EV55120-15  
 15 cm, 6"



FRIEDMANN  
 EV71351-10 10 cm, 4"  
 EV71351-15 15 cm, 6"



BOSE  
 EV55122-16  
 16 cm, 6 1/4"

links  
 left  
 izquierda  
 sinistra



BOSE  
 EV55124-16  
 16 cm, 6 1/4"

rechts  
 right  
 derecha  
 destra



WAGENER-MOSHER  
 EV55151-05 5 mm  
 EV55151-07 7 mm  
 EV55151-09 9 mm

Tracheal-Kanülen, Schilddrüsenhaken, Sonde, Kropffaßzange, Muskelklemme  
 Tracheal Tubes, Thyroid Gland Retractor, Directors-Enucleators, Goitre Seizing Forceps, Muscular Clamp  
 Cánulas traqueales, Separador para la glándula tiroidea, Sondas,  
 Pinza para coger el bocio, Pinza-clamp para músculos  
 Cannule tracheali, Divaricatori per la tiroide, Sonde, Pinze per gozzo, Pinza muscolare



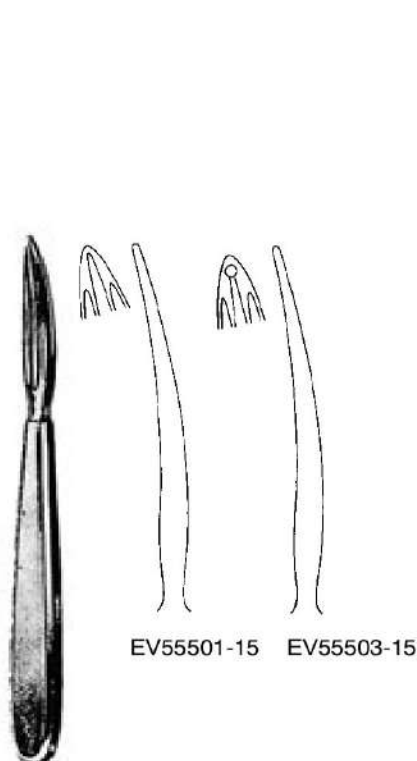
**LUER**  
 Neusilber Ger-  
 man silver  
 alpaca argentone

**CHEVALIER-JACKSON**  
 Neusilber  
 German silver  
 alpaca  
 argentone

| Fig. | Ø<br>mm | Länge des Außenrohrs<br>Length of outer tube<br>Largo de la cánula exterior<br>Lunghezza del tubo esterno |
|------|---------|---|
| 0    | 4       | 45 mm   |
| 1    | 5       | 50 mm   |
| 2    | 6       | 55 mm   |
| 3    | 7       | 60 mm   |
| 4    | 8       | 65 mm   |
| 5    | 9       | 70 mm   |
| 6    | 10      | 75 mm   |
| 7    | 11      | 80 mm   |
| 8    | 12      | 85 mm   |
| 9    | 13      | 90 mm   |

- EV55220-04
- EV55220-05
- EV55220-06
- EV55220-07
- EV55220-08
- EV55220-09
- EV55220-10
- EV55220-11
- EV55220-12
- EV55220-13

- EV55240-04
- EV55240-05
- EV55240-06
- EV55240-07
- EV55240-08
- EV55240-09
- EV55240-10
- EV55240-11
- EV55240-12
- EV55240-13



**KOCHER** EV55501-15 -  
 EV55503-15 15 cm, 6"

**SCHOENBORN**  
 EV55511-21  
 21 cm, 8 1/4"



**LAHEY**  
 EV55520-15 15 cm, 6"  
 EV55520-20 20 cm, 8"

**MASTIN**  
 EV55523-17  
 17 cm, 6 3/4"

Rippenscheren  
Rib Shears  
Costótomos  
Costotomi



COLLIN  
EV57102-23  
23 cm, 9"



EV57105-22  
22 cm, 8 3/4"



GLUCK  
EV57107-22  
22 cm, 8 3/4"

mit ziehendem Schnitt  
with eccentric sliding blade  
con hoja de retroacción  
con lama di retroazione



STILLE  
EV57111-21  
21 cm, 8 1/4"

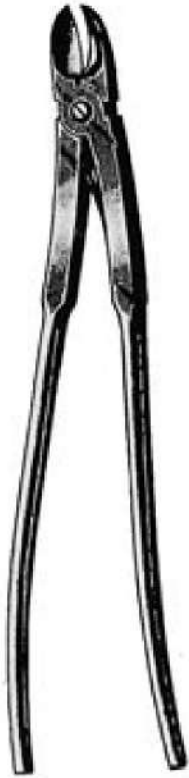


CORYLLOS  
EV57125-35  
35 cm, 13 3/4"



CORYLLOS  
EV57123-35  
35 cm, 13 3/4"

Rippenscheren, Sternumscheren  
Rib Shears, Sternum Scissors  
Costótomos, Tijeras de esternón  
Costotomi, Forbici per sterno



BETHUNE  
EV57126-34  
34 cm, 13 1/2"



SAUERBRUCH  
EV57131-26  
26 cm, 10 1/4"



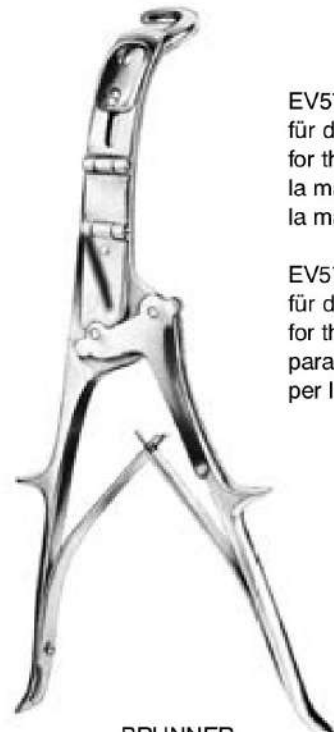
GIERTZ-STILLE  
EV57137-27  
27 cm, 10 1/2"



SCHUMACHER  
EV57138-21  
21 cm, 8 1/4"



SAUERBRUCH-FREY  
EV57141-36 36 cm,  
14.2"



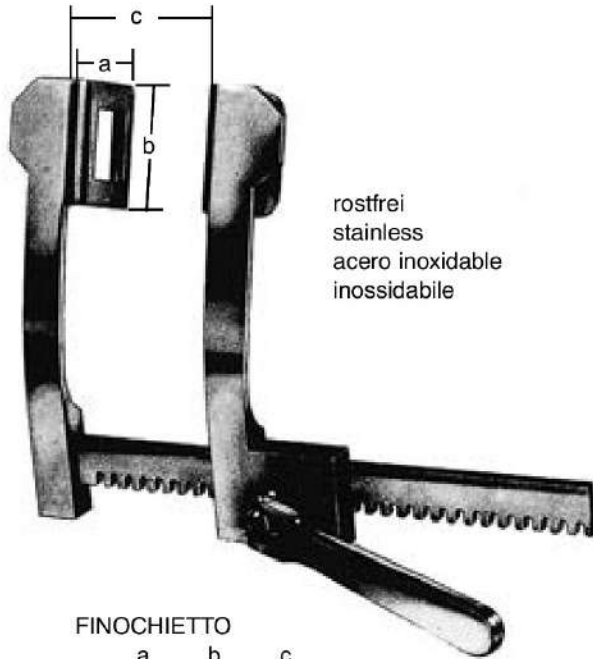
BRUNNER  
EV57146-28 -  
EV57147-28 28 cm, 11"

EV57146-28  
für die rechte Hand  
for the right hand para  
la mano derecha per  
la mano destra

EV57147-28  
für die linke Hand  
for the left hand  
para la mano izquierda  
per la mano sinistra

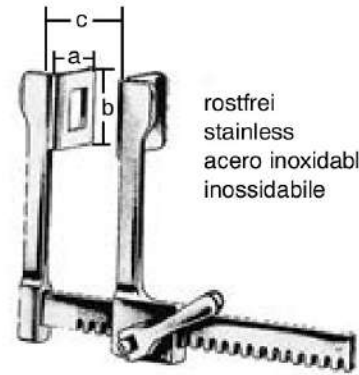


Rippensperrer  
 Rib Spreaders  
 Separadores costales  
 Divaricatori costali



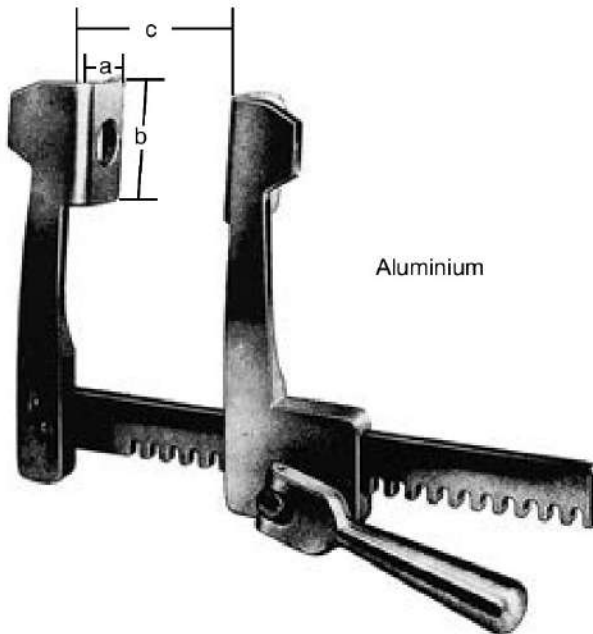
rostfrei  
 stainless  
 acero inoxidable  
 inossidabile

| FINOCHIETTO |    |    |     |
|-------------|----|----|-----|
|             | a  | b  | c   |
|             | mm | mm | mm  |
| EV57210-16  | 38 | 44 | 160 |
| EV57210-20  | 52 | 62 | 200 |
| EV57210-25  | 65 | 85 | 250 |



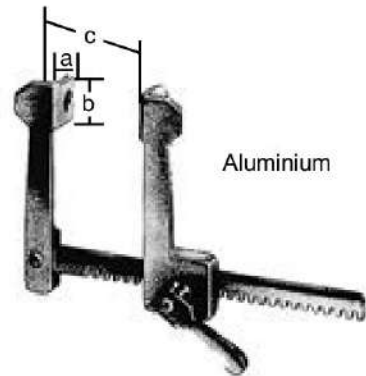
rostfrei  
 stainless  
 acero inoxidable  
 inossidabile

| FINOCHIETTO-BABY |    |    |    |
|------------------|----|----|----|
|                  | a  | b  | c  |
|                  | mm | mm | mm |
| EV57214-75       | 18 | 20 | 75 |



Aluminium

| FINOCHIETTO |    |    |     |
|-------------|----|----|-----|
|             | a  | b  | c   |
|             | mm | mm | mm  |
| EV57230-13  | 38 | 44 | 135 |
| EV57230-17  | 52 | 62 | 175 |
| EV57230-18  | 85 | 65 | 175 |



Aluminium

| FINOCHIETTO-BABY |    |    |    |
|------------------|----|----|----|
|                  | a  | b  | c  |
|                  | mm | mm | mm |
| EV57234-75       | 15 | 15 | 75 |

Rippensperrer  
Rib Spreaders  
Separadores costales  
Divaricatori costali

FINOCHIETTO-BURFORD

|            | a  | b  | c   |
|------------|----|----|-----|
|            | mm | mm | mm  |
| EV57236-20 | 65 | 62 | 200 |
|            | 47 | 62 |     |
| EV57236-25 | 65 | 62 | 250 |
|            | 47 | 62 |     |
| EV57236-30 | 65 | 62 | 300 |
|            | 47 | 52 |     |



rostfrei  
stainless  
acero inoxidable  
inossidabile

Erwachsene  
Adult Size  
para adultos  
per adulti

FINOCHIETTO-BURFORD

|            | a  | b  | c   |
|------------|----|----|-----|
|            | mm | mm | mm  |
| EV57242-20 | 47 | 62 | 200 |
|            | 65 | 62 |     |
| EV57242-25 | 47 | 62 | 250 |
|            | 65 | 62 |     |
| EV57242-30 | 47 | 62 | 300 |
|            | 65 | 62 |     |



Aluminium

Kinder  
Child Size  
para niños  
per bambini

FINOCHIETTO-BURFORD

|            | a  | b  | c   |
|------------|----|----|-----|
|            | mm | mm | mm  |
| EV57244-13 | 34 | 42 | 135 |
|            | 48 | 42 |     |

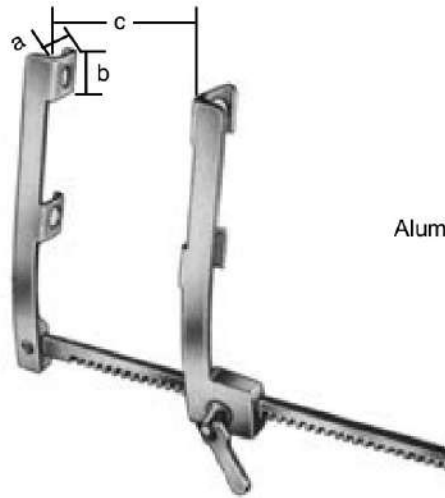


Aluminium

Rippensperrer  
 Rib Spreaders  
 Separadores costales  
 Divaricatori costali

FINOCHIETTO

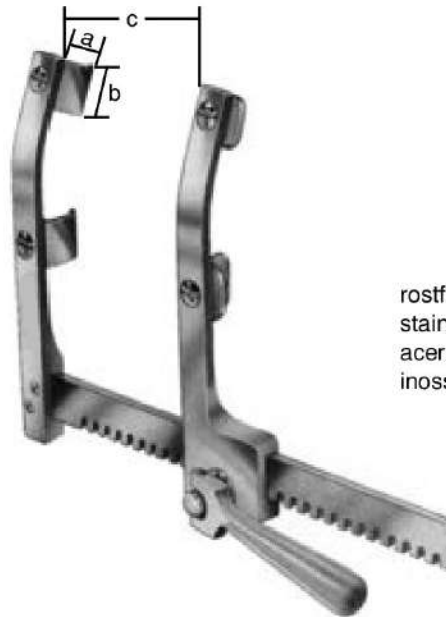
|            | a  | b  | c   |
|------------|----|----|-----|
|            | mm | mm | mm  |
| EV57245-13 | 14 | 14 | 120 |



Aluminium

MORSE

|            | a  | b  | c   |
|------------|----|----|-----|
|            | mm | mm | mm  |
| EV57246-16 | 17 | 22 | 160 |



rostfrei  
 stainless  
 acero inoxidable  
 inossidabile

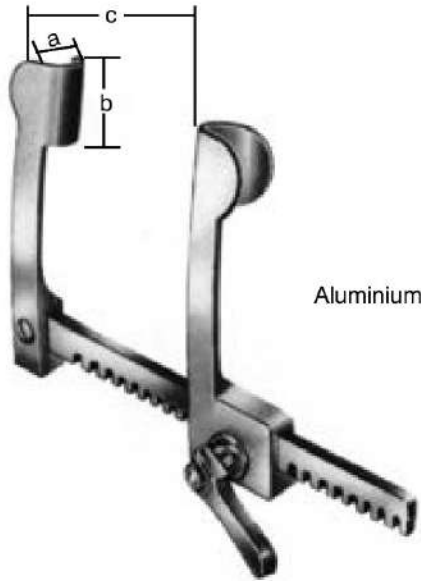
MORSE-FAVALORO

|            | a  | b  | c   |
|------------|----|----|-----|
|            | mm | mm | mm  |
| EV57246-21 | 19 | 27 | 210 |



rostfrei  
 stainless  
 acero inoxidable  
 inossidabile

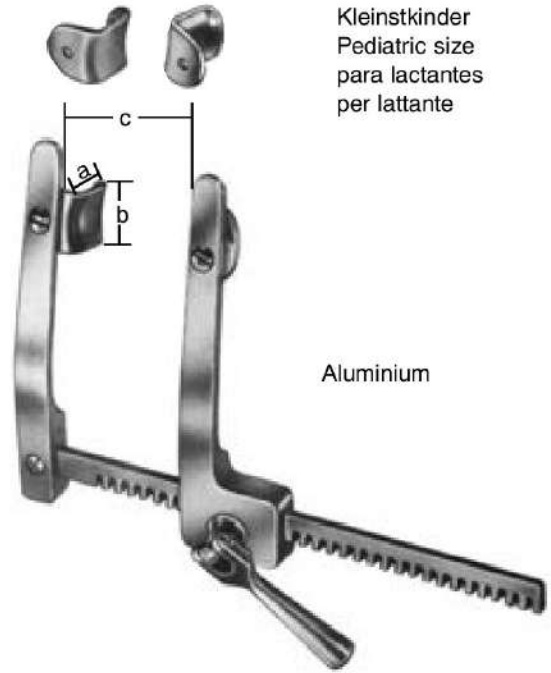
Rippensperrer  
Rib Spreaders  
Separadores costales  
Divaricatori costali



Aluminium

COOLEY-NEONATAL

|            | a  | b  | c  |
|------------|----|----|----|
|            | mm | mm | mm |
| EV57247-95 | 12 | 16 | 95 |

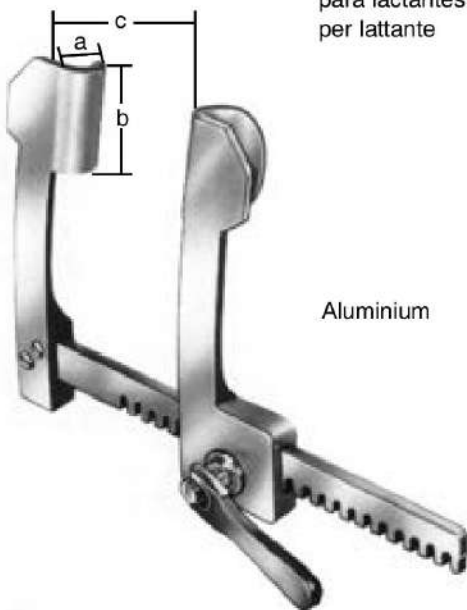


Aluminium

Kleinstkinder  
Pediatric size  
para lactantes  
per lattante

COOLEY

|            | a  | b  | c  |
|------------|----|----|----|
|            | mm | mm | mm |
| EV57249-01 | 10 | 14 | 90 |



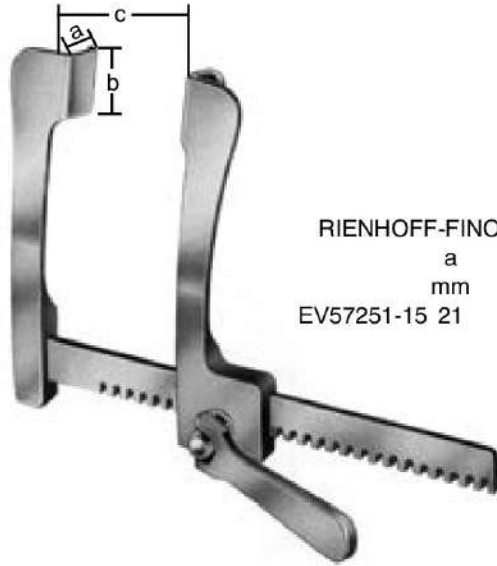
Aluminium

Kleinstkinder  
Pediatric size  
para lactantes  
per lattante

COOLEY

|            | a  | b  | c   |
|------------|----|----|-----|
|            | mm | mm | mm  |
| EV57248-14 | 15 | 30 | 140 |

Rippensperrer  
 Rib Spreaders  
 Separadores costales  
 Divaricatori costali



RIENHOFF-FINOCHIETTO  
 a b c  
 mm mm mm  
 EV57251-15 21 26 150

rostfrei  
 stainless  
 acero inoxidable  
 inossidabile

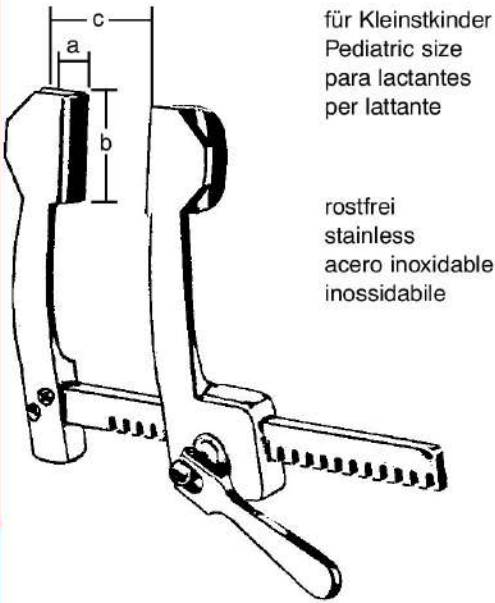


DE BOER  
 a b c  
 mm mm mm  
 EV57252-19 27 100 190

rostfrei  
 stainless  
 acero inoxidable  
 inossidabile

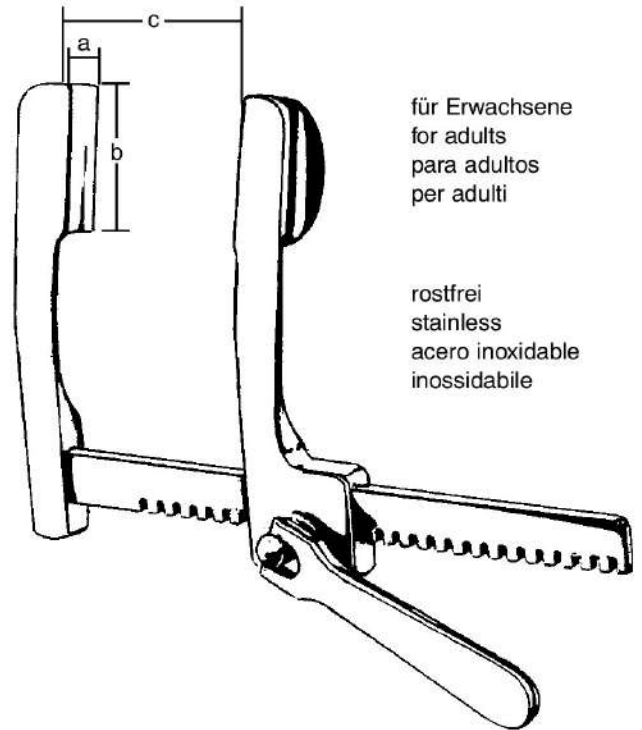
Rippensterrer  
Rib Spreaders  
Separadores costales  
Divaricatori costali

GERNAL SURGICAL



für Kleinstkinder  
Pediatric size  
para lactantes  
per lattante

rostfrei  
stainless  
acero inoxidable  
inossidabile



für Erwachsene  
for adults  
para adultos  
per adulti

rostfrei  
stainless  
acero inoxidable  
inossidabile

COOLEY

|            | a  | b  | c   |
|------------|----|----|-----|
|            | mm | mm | mm  |
| EV57260-02 | 16 | 30 | 105 |
| EV57260-03 | 21 | 44 | 150 |

COOLEY

|            | a  | b  | c   |
|------------|----|----|-----|
|            | mm | mm | mm  |
| EV57260-04 | 37 | 49 | 200 |



rostfrei  
stainless  
acero inoxidable  
inossidabile



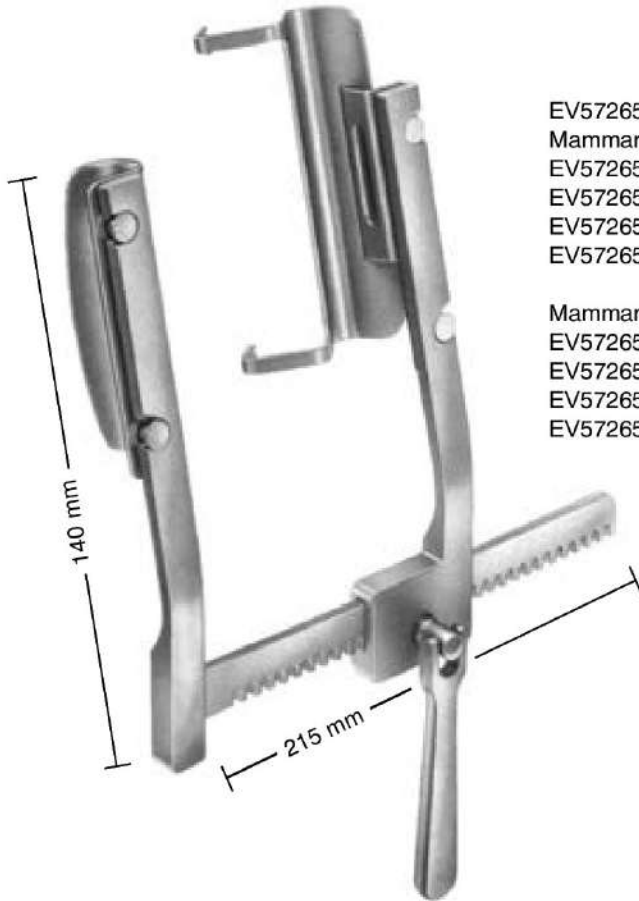
rostfrei  
stainless  
acero inoxidable  
inossidabile

HAIGHT

|            | a  | b  | c  | h  |
|------------|----|----|----|----|
|            | mm | mm | mm | mm |
| EV57260-06 | 30 | 30 | 90 | 65 |
| EV57260-09 | 30 | 30 | 90 | 90 |

TUFFIER

|            | a  | b  | c   |
|------------|----|----|-----|
|            | mm | mm | mm  |
| EV57264-16 | 50 | 45 | 165 |



- EV57265-00  
Mammaria Sperrer, komplett bestehend aus:  
EV57265-10 Sperrer allein  
EV57265-20 Mammariablatt, komplett mit Aufnahmeblatt links und rechts  
EV57265-30 1 Paar Sternumblätter 30x100 mm  
EV57265-40 1 Paar Sternumblätter 40x100 mm

- Mammaria spreader, complete consisting of:  
EV57265-10 Retractor only  
EV57265-20 Mammariablade complete with holding blades left and right  
EV57265-30 1 pair of sternum blades 30x100 mm  
EV57265-40 1 pair of sternum blades 40x100 mm



EV57265-20 Mammariablatt, komplett  
Mammariablade, complete

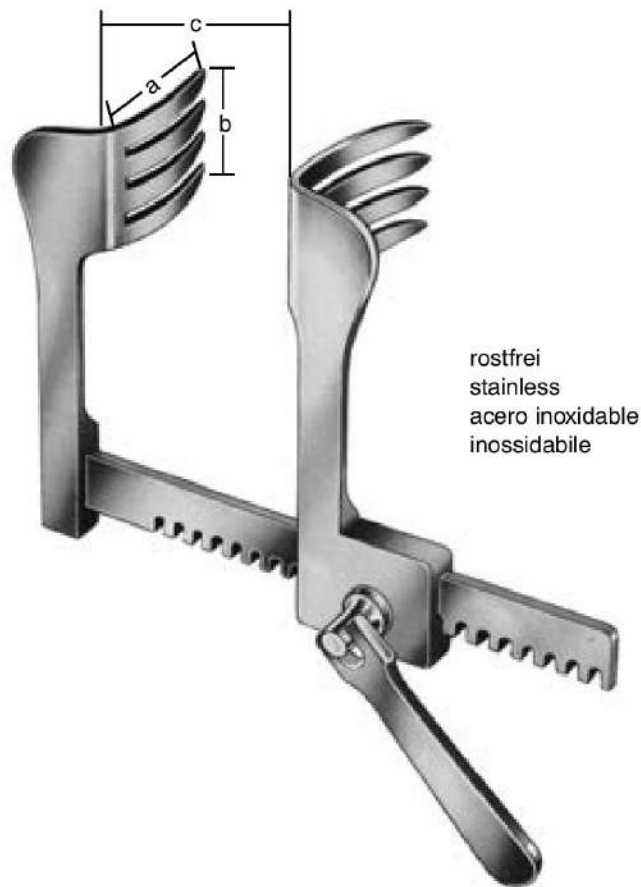


EV57265-30  
Sternumblätter 30x100 mm  
Sternum blades 30x100 mm



EV57265-40  
Sternumblätter 40x100 mm  
Sternum blades 40x100 mm

Laminektomie-Sperrer  
Laminectomy-Retractor  
Separadores para laminectomía  
Divaricatori Laminectomia



| CHERRY     |    |    |     |
|------------|----|----|-----|
|            | a  | b  | c   |
|            | mm | mm | mm  |
| EV57266-13 | 44 | 70 | 135 |



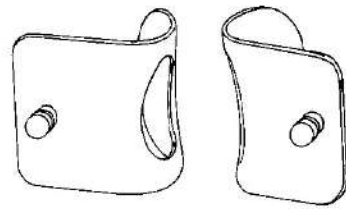
Thoraxsperrer  
Thoracic retractor  
Separador torácico  
Divaricatore per il torace



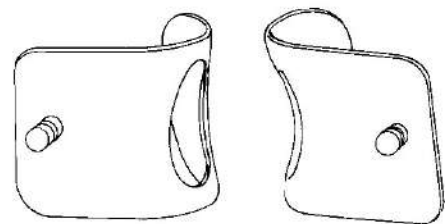
MERCEDES compl.  
EV57270-00

EV57270-80  
Sperrer allein  
Retractor only  
Separador solo  
Divaricatore solo

rostfrei  
stainless  
acero inoxidable  
inossidabile



EV57270-65  
42x65 mm



EV57270-75  
75x75 mm

Rippenkontraktoren  
 Rib Contractors  
 Aproximadores para costillas  
 Approssimatori costali



SELLORS  
 EV57280-19  
 20 cm, 8"



BAILEY-BABY  
 EV57283-14  
 14 cm, 5 1/2"



BAILEY  
 EV57284-16  
 16 cm, 6 1/4"

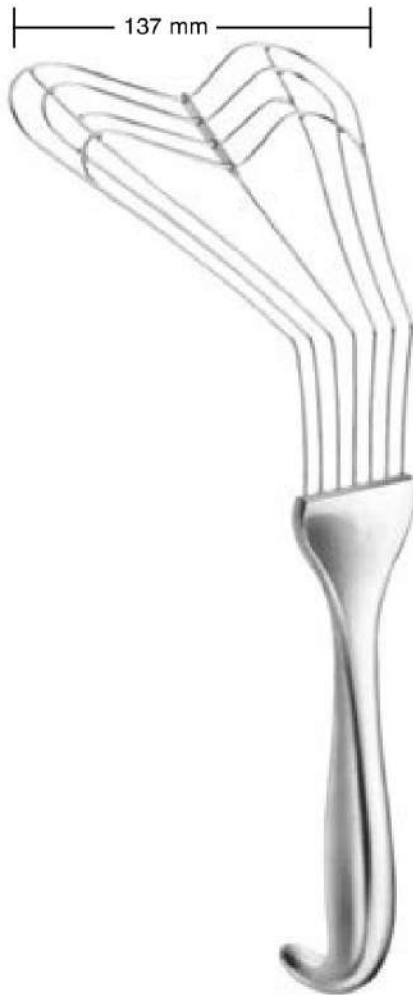
kurze Klauen  
 short claws  
 garras cortas  
 pinze corte



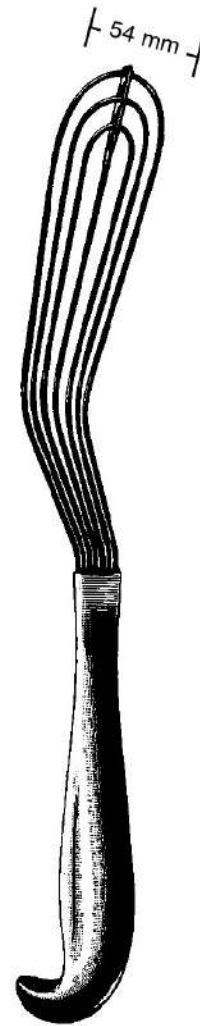
BAILEY-GIBBON  
 EV57286-16 16  
 cm, 6 1/4"

lange Klauen  
 long claws  
 garras largas  
 pinze lunghe

Lungenspatel  
Lung Spatulas  
Espátulas pulmonares  
Spatole per polmone



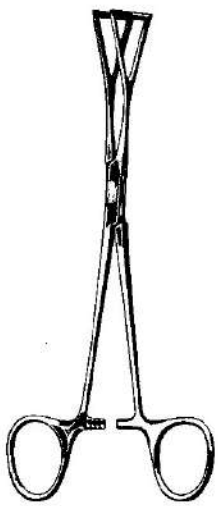
EV57288-30  
30 cm, 11 <sup>3</sup>/<sub>4</sub>"



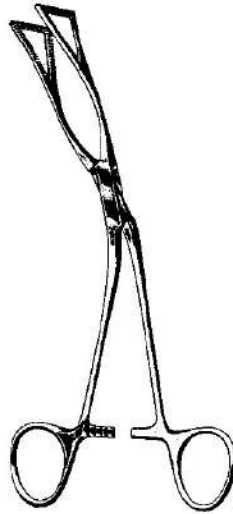
ALLISON  
EV57289-32  
32 cm, 12 <sup>3</sup>/<sub>4</sub>"



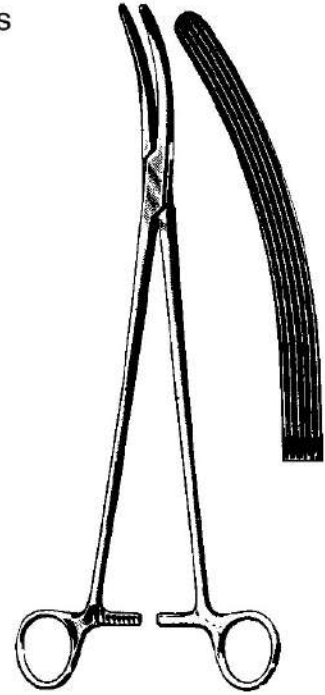
Lungenfaßzange, Bronchusklemmen  
 Lung Grasping Forceps, Bronchus Forceps  
 Pinzas para coger el pulmón, Pinzas clamps bronquiales  
 Pinze per afferrare il polmone, Pinze per bronchi



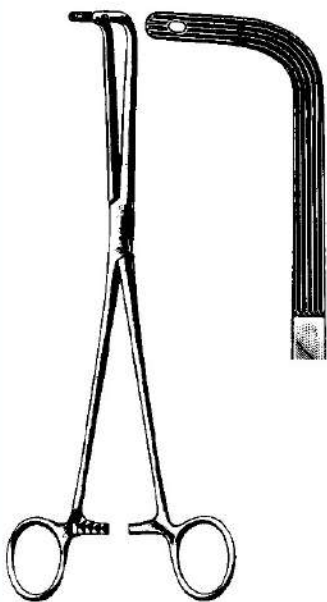
LOVELACE  
 EV57290-20  
 20 cm, 8"



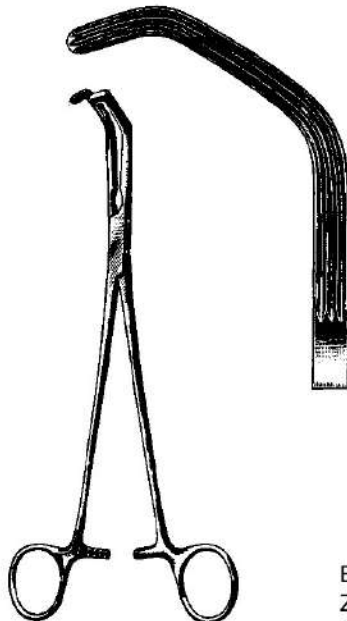
LOVELACE  
 EV57291-20  
 20 cm, 8"



HARRINGTON  
 EV57301-30  
 30,5 cm, 12"



FINOCIETTO  
 EV57307-24  
 24 cm, 9 1/2"



PRICE-THOMAS  
 EV57309-22 22  
 cm, 8 3/4"

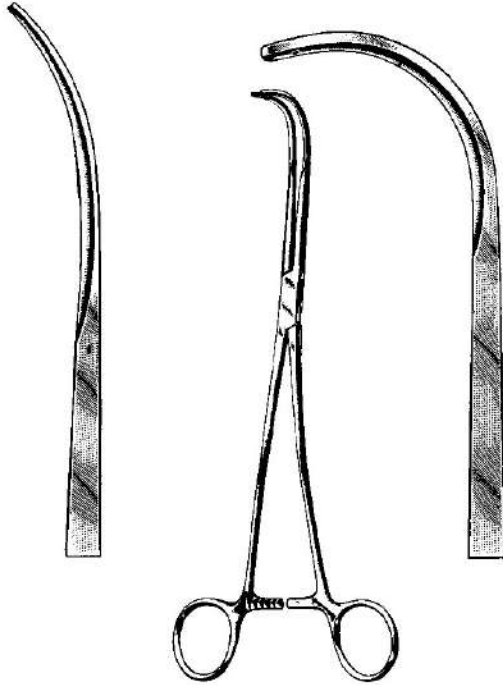
EV57311-22  
 Zähne links  
 tooth left dientes  
 izquierda denti  
 sinistro



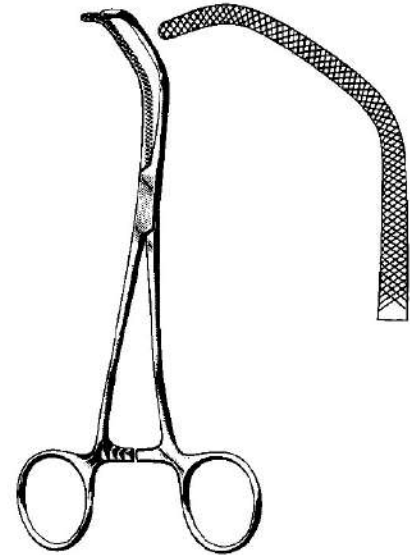
PRICE-THOMAS  
 22 cm, 8 3/4"

EV57313-22  
 Zähne rechts  
 tooth right di-  
 entes derecha  
 denti destro

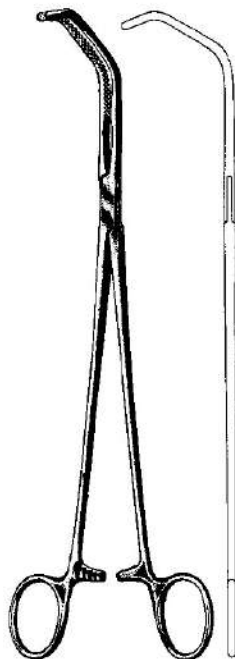
Bronchusklemmen, Gefäßklemmen  
 Bronchus Forceps, Blood Vessel Clamps  
 Pinzas clamps bronquiales, Pinzas-clamps para vasos  
 Pinze per bronchi, Pinze cardiovascolari



EV57321-23 SEMB 23 cm, 9" EV57323-23



SATINSKY EV57325-15 15 cm, 6"



SATINSKY EV57327-26 - EV57329-26 26 cm, 10 1/4"

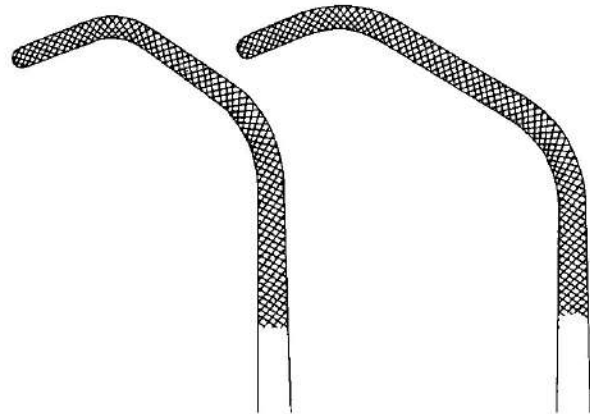
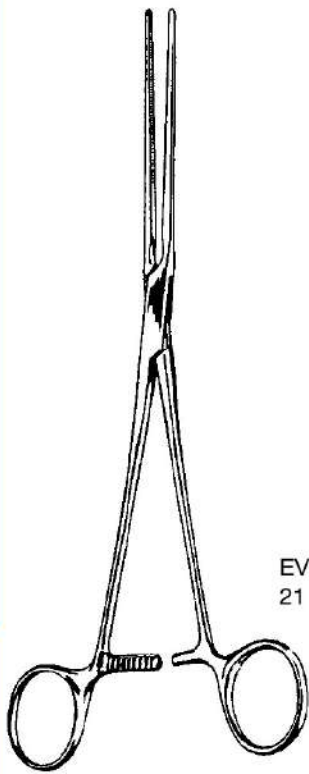


Fig. 1 EV57327-26

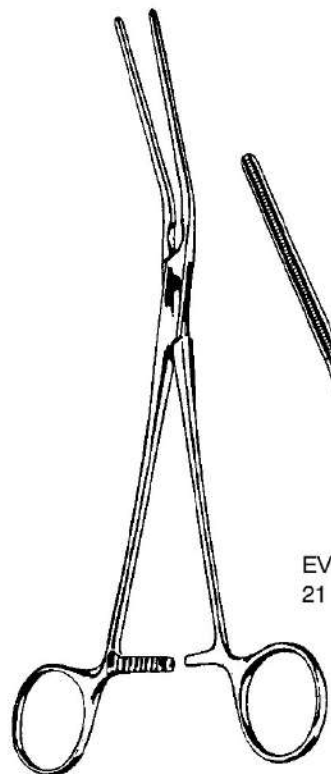
Fig. 2 EV57329-26



EV61000-21  
 21 cm, 8 1/4"

EV61000-22  
 22 cm, 8 3/4"

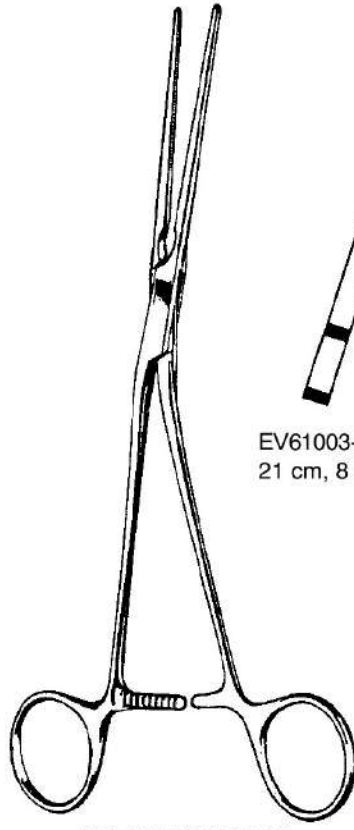
POTTS EV61000-21  
 - EV61000-22



EV61001-21  
 21 cm, 8 1/4"

EV61001-22  
 22 cm, 8 3/4"

POTTS EV61001-21  
 - EV61001-22

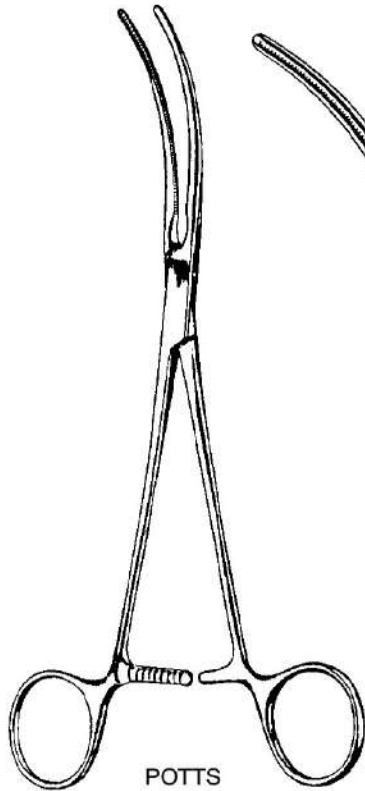


EV61003-21  
 21 cm, 8 1/4"

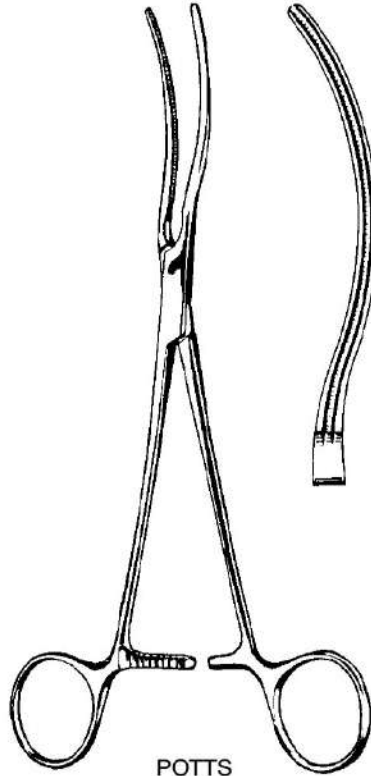
EV61003-22  
 22 cm, 8 3/4"

POTTS EV61003-21  
 - EV61003-22

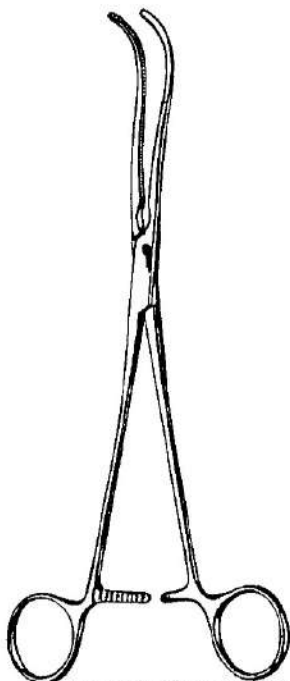
Anastomosen-Klemmen, Präparier- und Ligaturklemmen  
 Anastomosis clamps, Dissecting and ligature forceps  
 Pinzas clamps para anastomosis, Pinzas para preparaciones y ligaduras  
 Pinze per anastomosi, Pinze per preparazioni e legature



POTTS  
 EV61005-22  
 22 cm, 8 3/4"



POTTS  
 EV61007-22  
 22 cm, 8 3/4"



DE BAKEY EV61008-19 -  
 EV61008-23

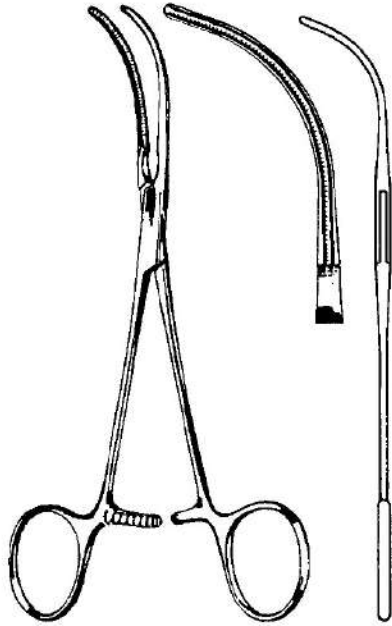


EV61008-19  
 19 cm, 7 1/2"



EV61008-23  
 23 cm, 9"

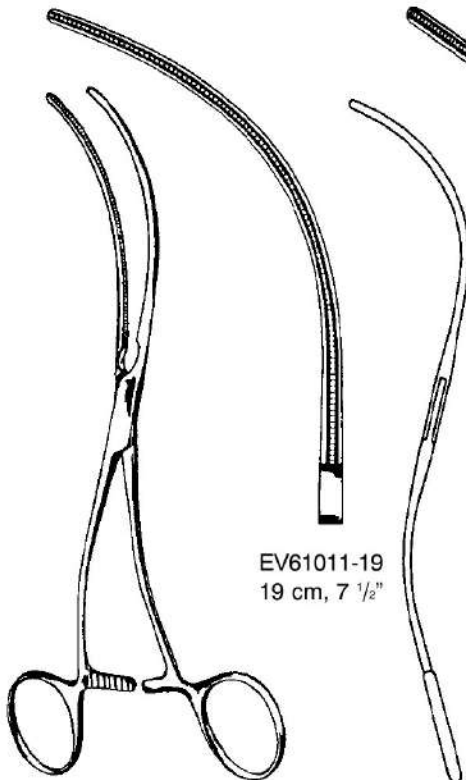
Peripheral-Gefäßklemmen  
 Peripheral vascular clamps  
 Pinzas-clamps para vasos periféricos  
 Pinze vascolari periferici



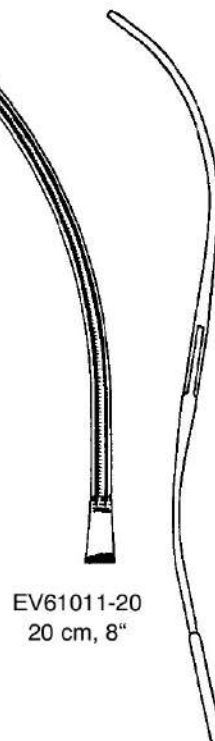
DE BAKEY  
 EV61009-16  
 16 cm, 6 1/4"



DALE  
 EV61010-18  
 18 cm, 7"



EV61011-19  
 19 cm, 7 1/2"



EV61011-20  
 20 cm, 8"

DE BAKEY EV61011-19 -  
 EV61011-20



Peripheral-Gefäßklemmen  
 Peripheral vascular clamps  
 Pinzas-clamps para vasos periféricos  
 Pinze vascolari periferici



DALE

EV61012-17  
 17,5 cm, 7"



EV61012-18  
 18 cm, 7"



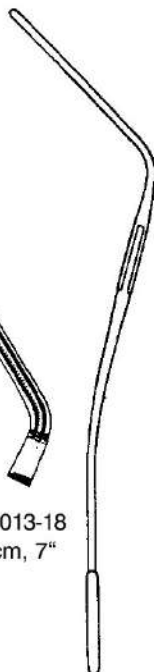
EV61012-19  
 18,5 cm, 7 1/4"



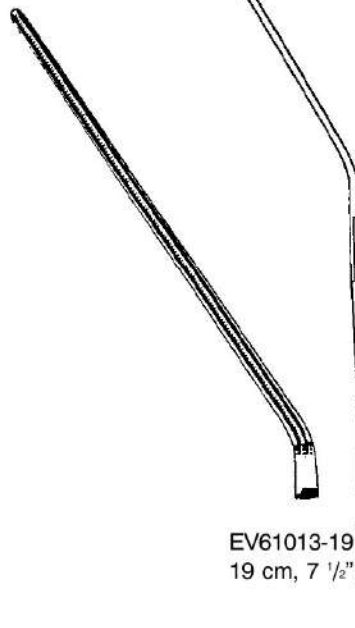
LELAND-JONES

EV61013-18 - EV61013-20

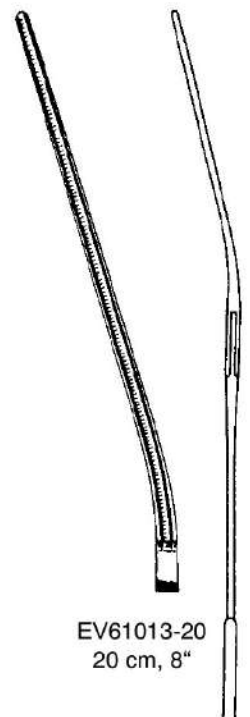
EV61013-18  
 18 cm, 7"



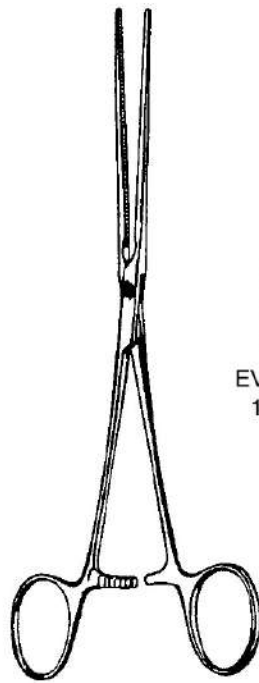
EV61013-19  
 19 cm, 7 1/2"



EV61013-20  
 20 cm, 8"



Mehrzweck-Gefäßklemme  
Multi Purpose Vascular Clamps  
Pinzas vasculares de usos multiples  
Pinze vascolari universali



BAINBRIDGE EV61014-15  
- EV61014-18



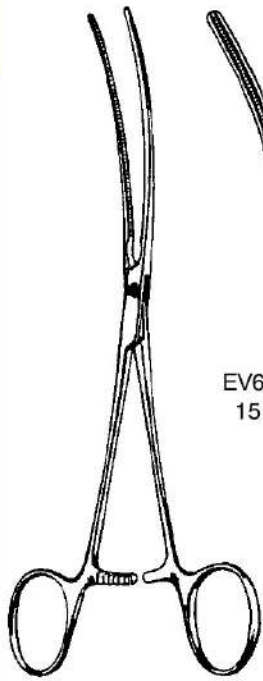
EV61014-15  
15 cm, 6"



EV61014-18  
18 cm, 7"

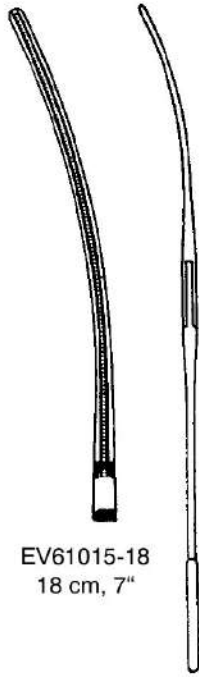
Mehrzweck-Gefäßklemme  
Multi Purpose Vascular Clamps  
Pinzas vasculares de usos multiples  
Pinze vascolari universali

GENERAL SURGICAL

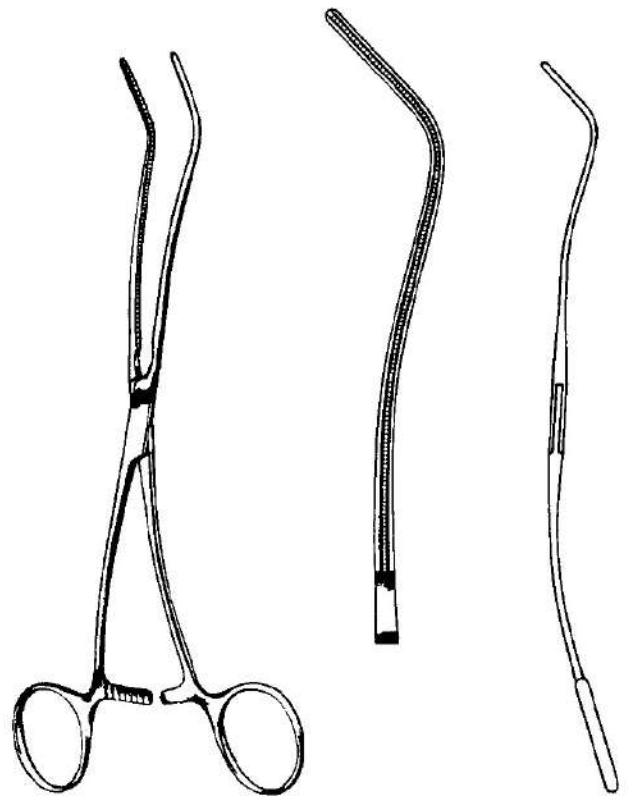


EV61015-15  
15 cm, 6"

BAINBRIDGE EV61015-15 -  
EV61015-18

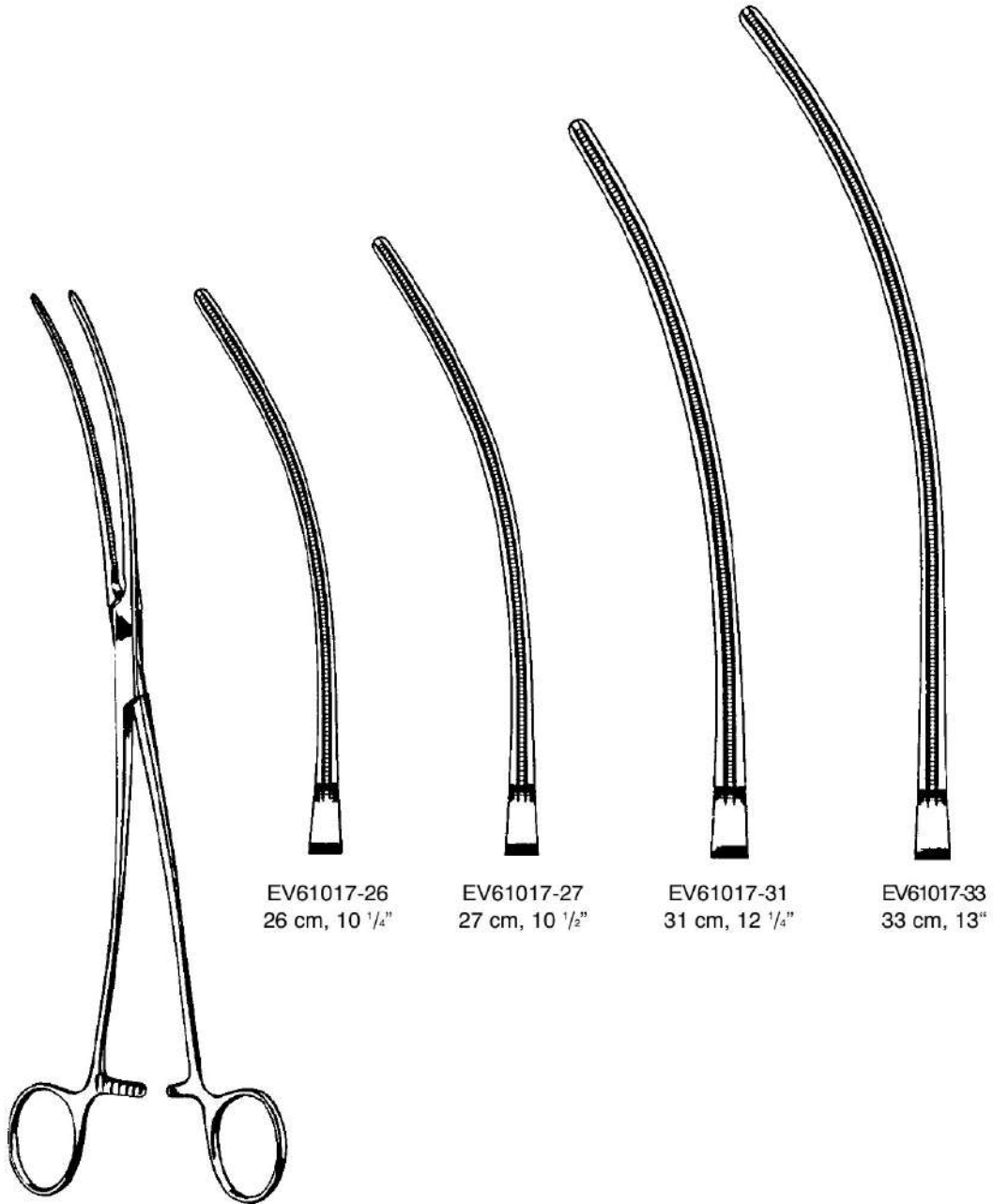


EV61015-18  
18 cm, 7"



DE BAKEY  
EV61016-20  
20 cm, 8"

Aorta-Aneurysmaklemmen  
Aortic aneurysm clamps  
Pinzas-clamps para aneurisma de la aorta  
Pinze per aneurisma aorta



EV61017-26  
26 cm, 10 1/4"

EV61017-27  
27 cm, 10 1/2"

EV61017-31  
31 cm, 12 1/4"

EV61017-33  
33 cm, 13"

DE BAKEY EV61017-26 -  
EV61017-33

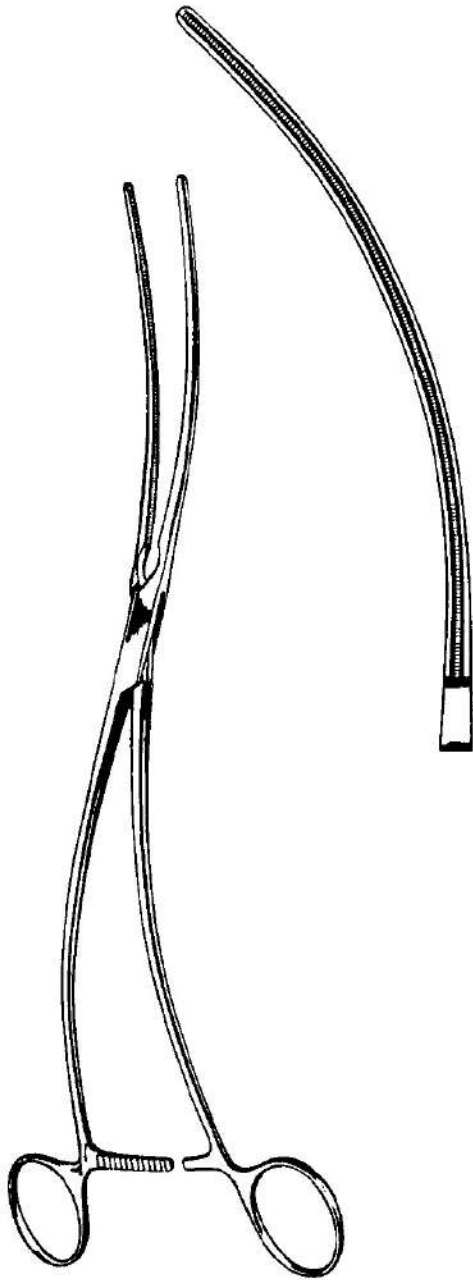
Aorta-Aneurysmaklemmen  
Aortic aneurysm clamps  
Pinzas-clamps para aneurisma de la aorta  
Pinze per aneurisma aorta



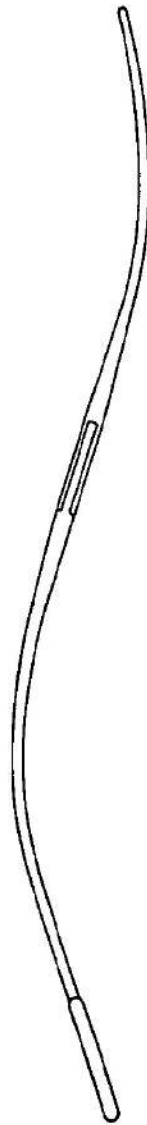
DE BAKEY  
EV61018-28  
28 cm, 11"



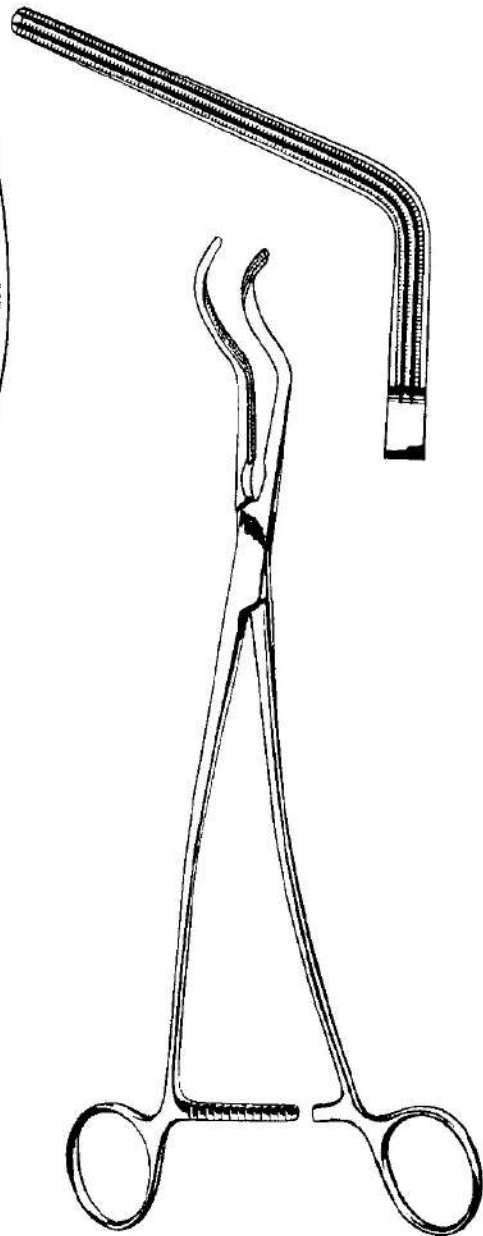
Aorta-Aneurysmaklemmen  
Aortic aneurysm clamps  
Pinzas-clamps para aneurisma de la aorta  
Pinze per aneurisma aorta



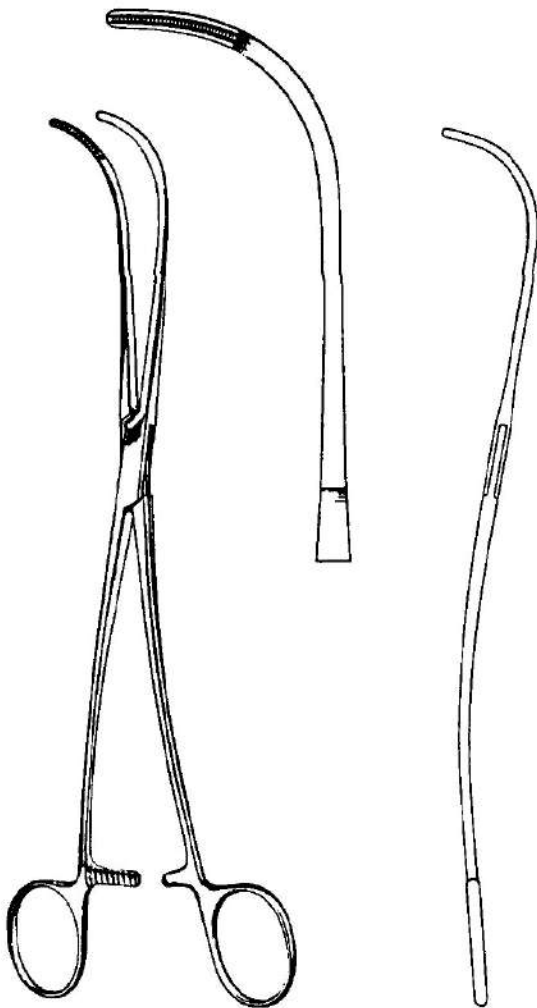
DE BAKEY  
EV61019-30  
30 cm, 11 3/4"



DE BAKEY  
EV61020-27  
27 cm, 10 1/2"



Präparier- und Ligaturklemme  
Dissecting- and Ligature clamp  
Pinzas clamps para disección, ligaduras  
Pinze per dissezione, legature



DE BAKEY  
EV61021-24  
24 cm, 9 1/2"

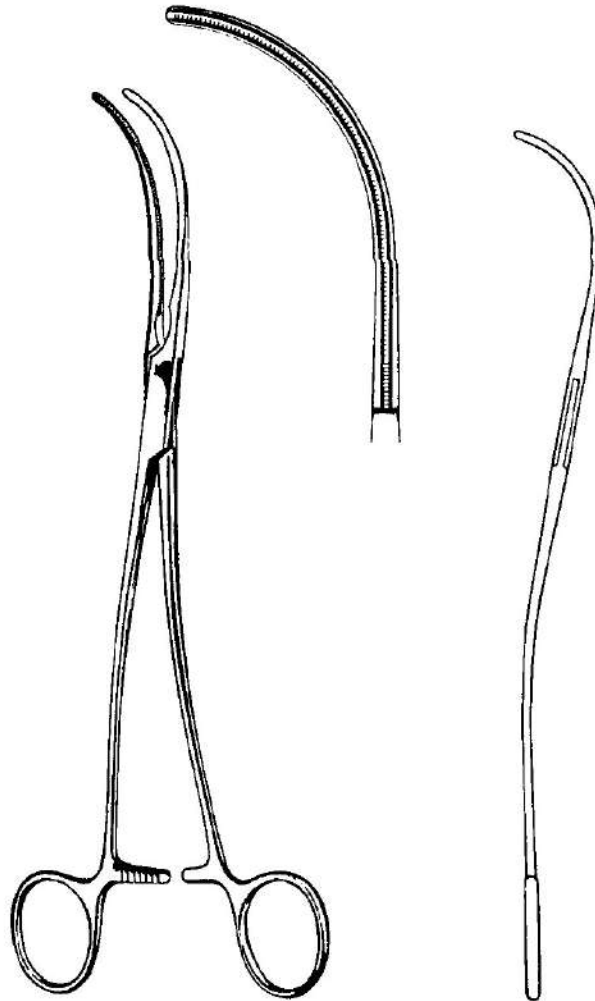


EV61022-01  
25 cm, 10"

EV61022-02  
24,5 cm, 9 3/4"

DE BAKEY-RUMEL

Ligaturklemmen  
Ligature clamps  
Pinzas clamps para ligaduras  
Pinze per legature



DE BAKEY  
EV61022-24  
24 cm, 9 1/2"



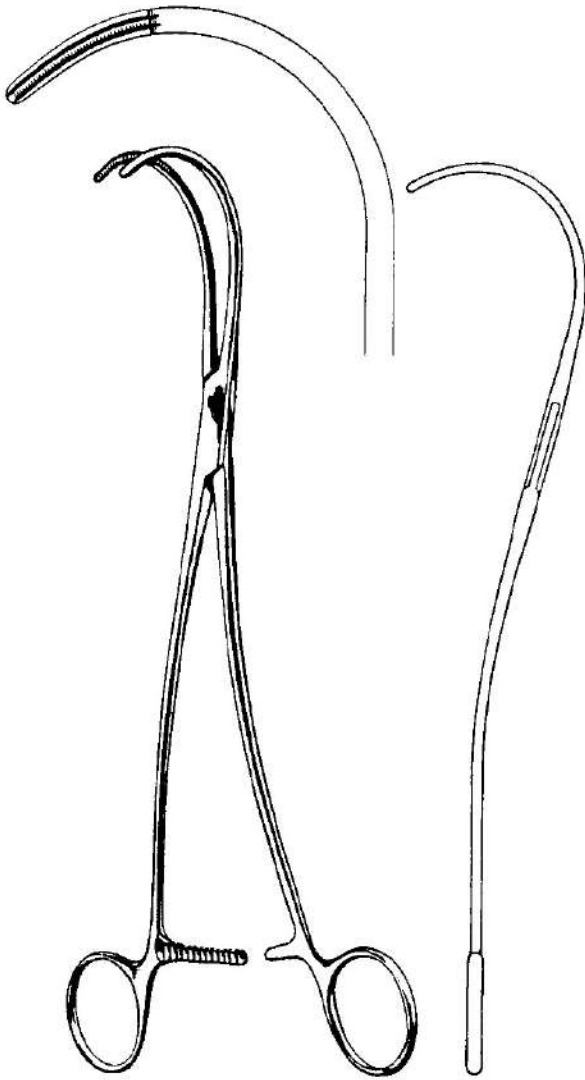


Präparier- und Ligaturklemmen  
Dissecting- and Ligature clamps  
Pinza para disección y ligatura  
Pinze per dissezione e legature

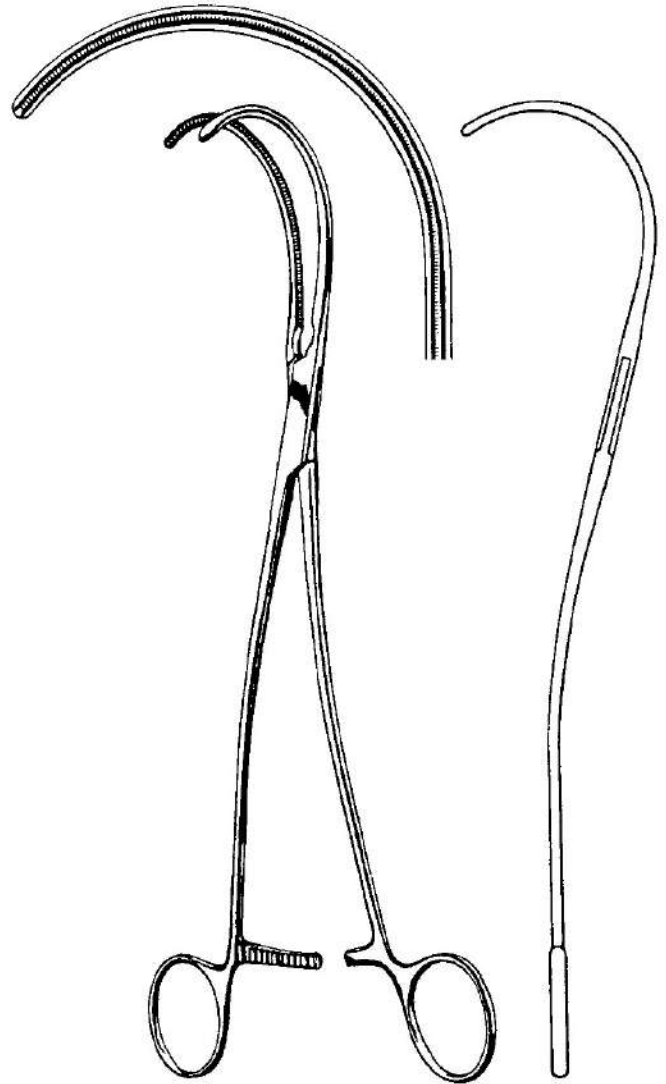


DE BAKEY-MIXTER  
EV61022-28 28,5  
cm, 11 1/4"

Ligaturklemme  
Ligature clamp  
Pinzas clamps para ligaduras  
Pinze per legature

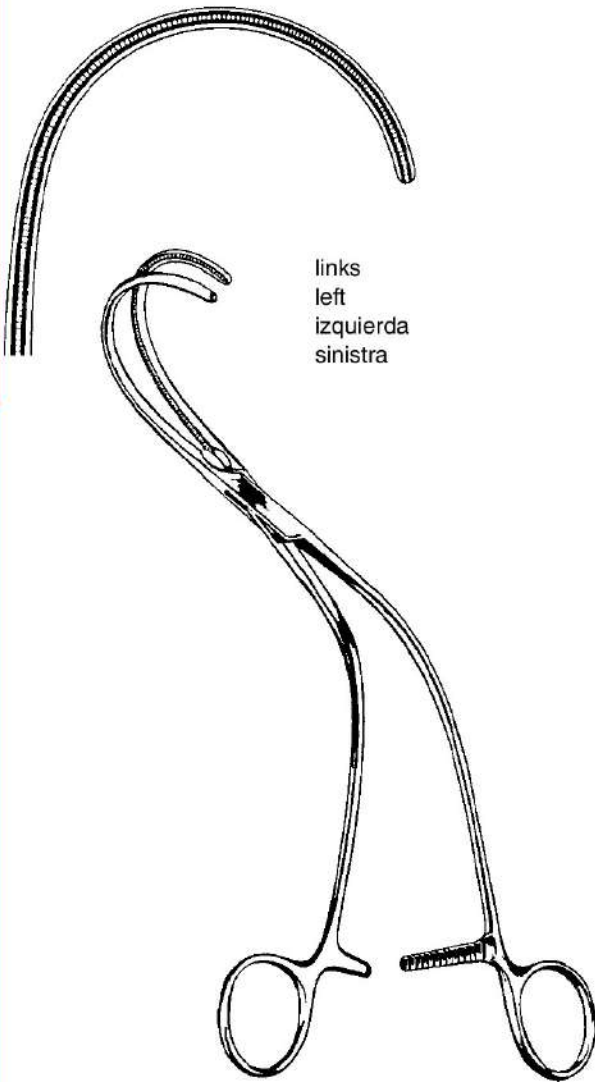


DE BAKEY  
EV61023-25  
25 cm, 10"



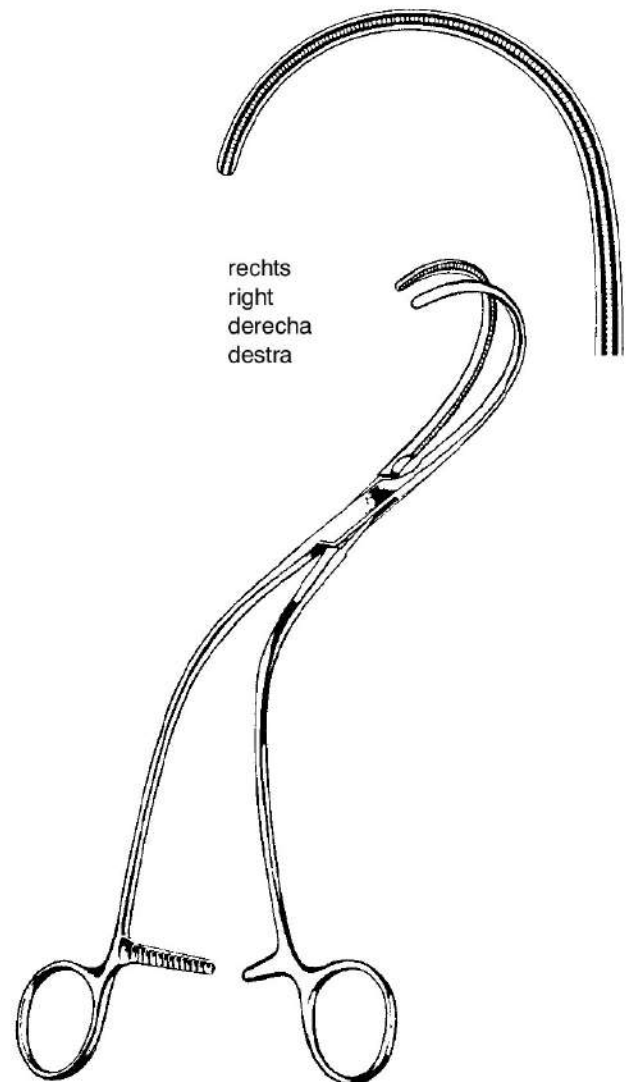
DE BAKEY  
EV61023-26  
26 cm, 10 1/4"

Aortaklemmen  
Aortic clamps  
Pinzas-clamps para la aorta  
Pinze per aorta



links  
left  
izquierda  
sinistra

WEBER  
EV61024-01  
26 cm, 10 1/4"



rechts  
right  
derecha  
destra

WEBER  
EV61024-02  
26 cm, 10 1/4"



Aortaklemmen  
Aortic clamps  
Pinzas-clamps para la aorta  
Pinze per aorta



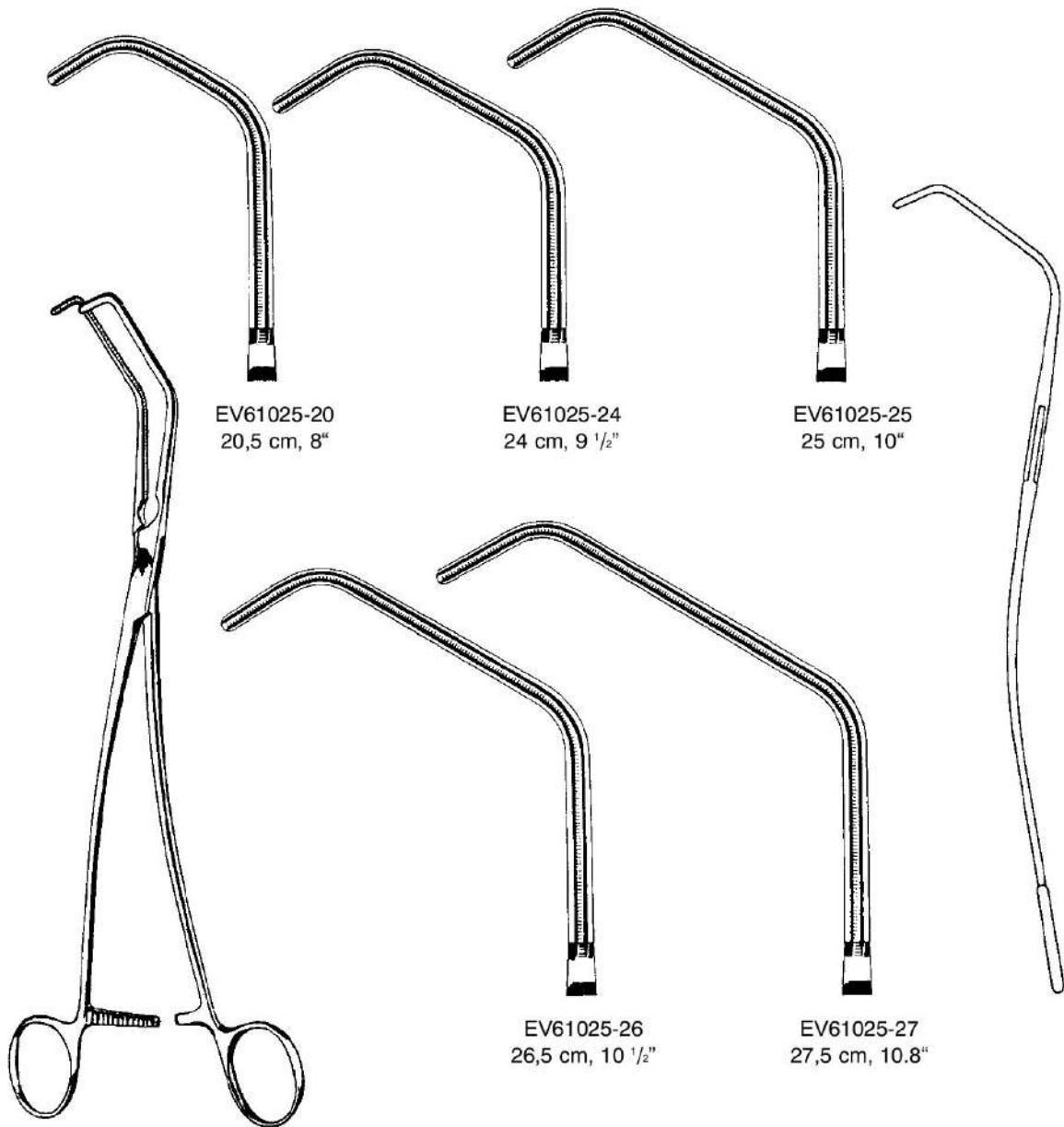
WYLIE  
EV61024-24  
24 cm, 9 1/2"

Aortaklemmen  
Aortic clamps  
Pinzas-clamps para la aorta  
Pinze per aorta



WYLIE  
EV61024-27  
27 cm, 10 1/2"

Tangentialklemmen  
Tangential occlusion clamps  
Pinzas-clamps para oclusión tangencial  
Pinze per occlusione tangenziale



EV61025-20  
20,5 cm, 8"

EV61025-24  
24 cm, 9 1/2"

EV61025-25  
25 cm, 10"

EV61025-26  
26,5 cm, 10 1/2"

EV61025-27  
27,5 cm, 10.8"

DE BAKEY-SATINSKY  
EV61025-20 - EV61025-27

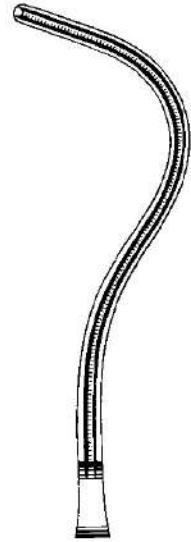
Aurikelklemmen  
 Auricle clamps  
 Pinza-clamps auriculares  
 Pinza auricula



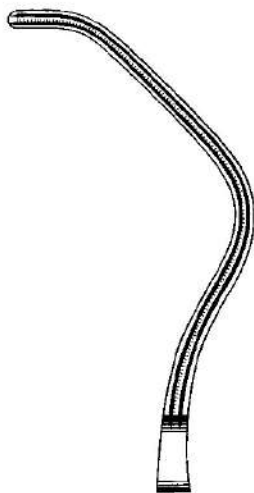
HARKEN EV61026-01 -  
 EV61026-04



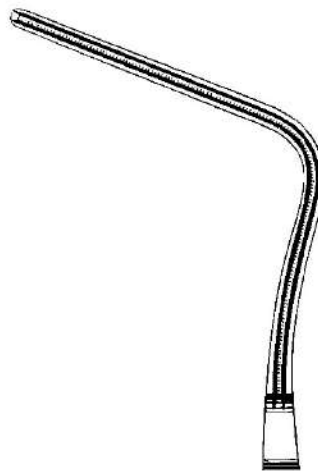
EV61026-01  
 24 cm, 9 1/2"



EV61026-02  
 24 cm, 9 1/2"



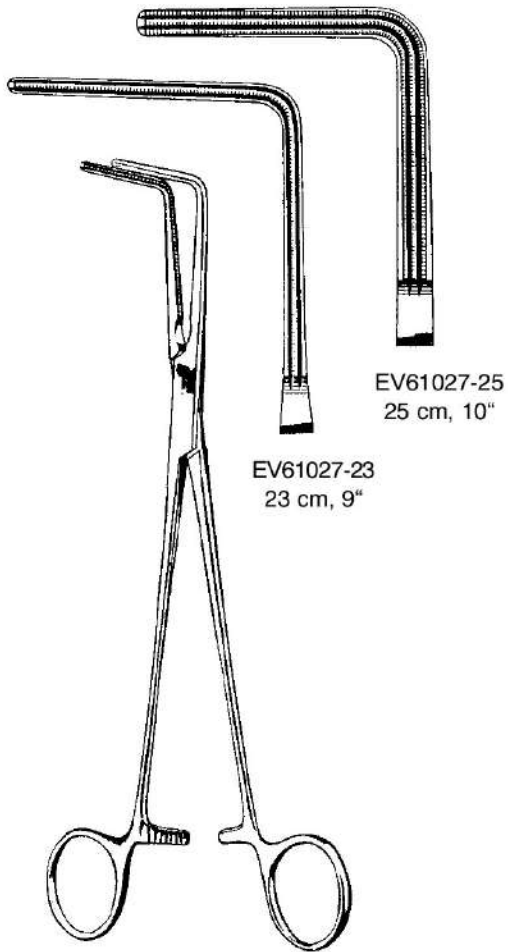
EV61026-03  
 24 cm, 9 1/2"



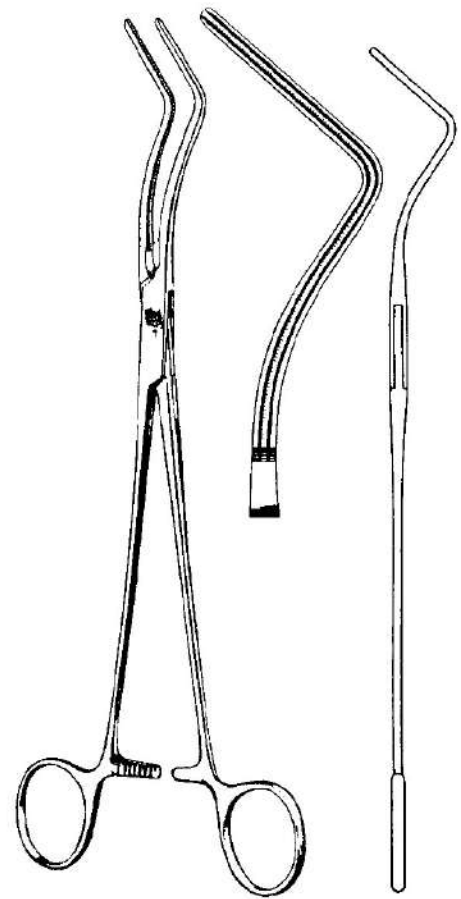
EV61026-04  
 24 cm, 9 1/2"



Bronchusklemmen  
Bronchus clamp  
Pinzas-clamps bronquiales  
Pinze per bronchi



LEES  
EV61027-23 -  
EV61027-25

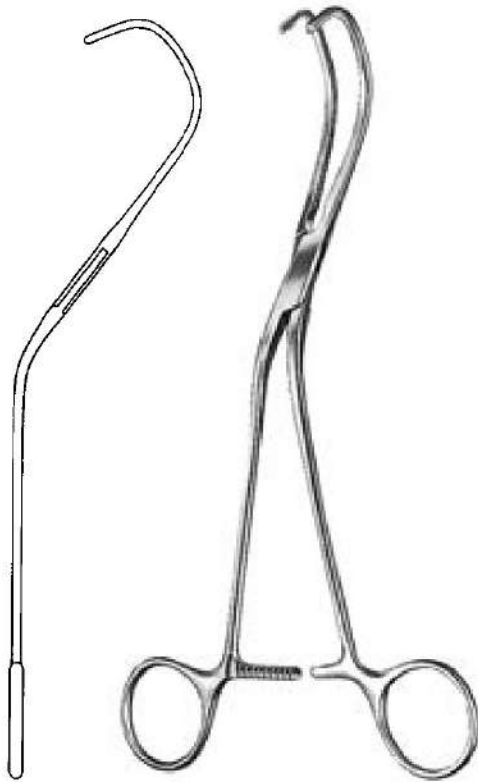


LEES  
EV61029-25  
25 cm, 10"

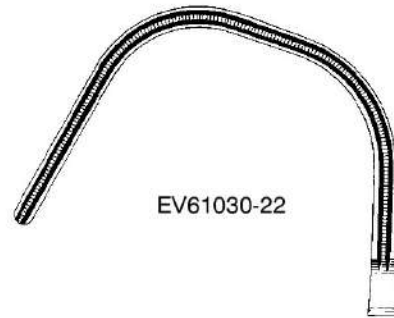




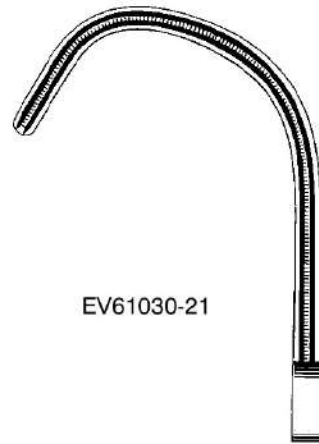
Aorta-Anastomosenklemmen  
Aortic anastomosis Clamps  
Pinzas-clamps para anastomosis  
Pinze anastomosi aorta



LAMBERT-KAY 21 cm, 8 1/4"  
EV61030-21 - EV61030-22



EV61030-22



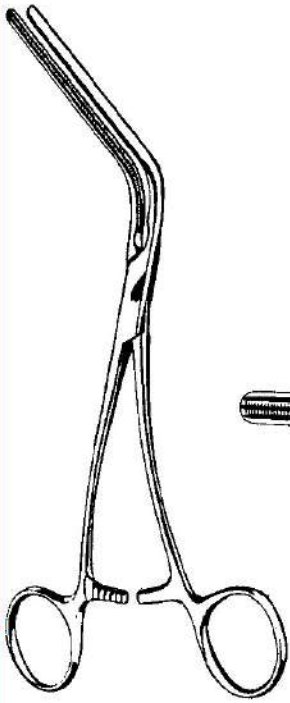
EV61030-21



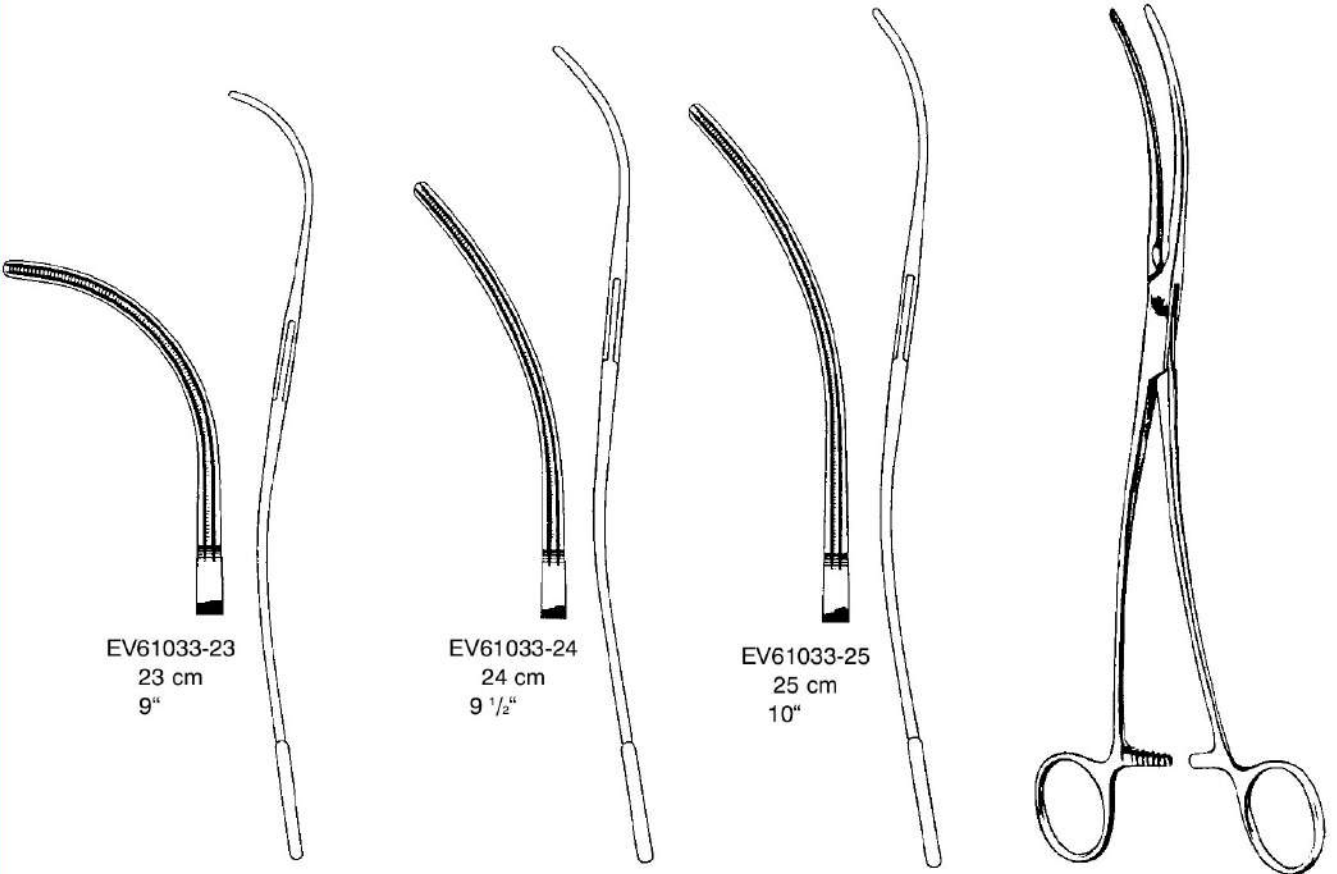
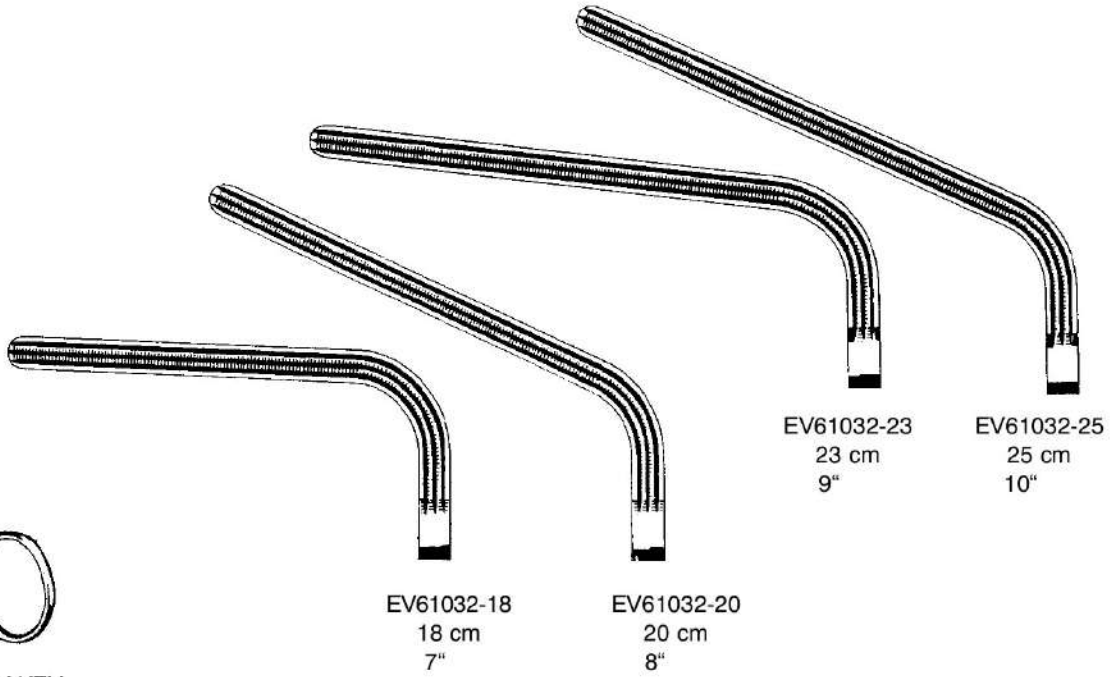
DE BAKEY  
EV61031-17  
17 cm, 6 3/4"

Aorta- und Aneurysmaklemme  
 Aortic- and Aneurysm Clamps  
 Pinzas aórticas y para aneurisma  
 Pinze per aorta e per aneurisma

GENERAL SURGICAL

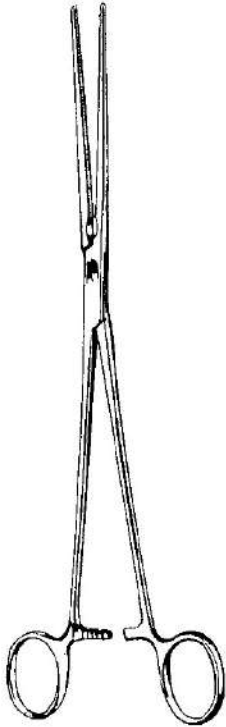


MORRIS-DE BAKEY  
 EV61032-18 - EV61032-25



DE BAKEY-BAHNSON  
 EV61033-23 - EV61033-25

Mehrzweck-Gefäßklemme  
 Multi purpose Vascular Clamps  
 Pinzas vasculares de usos multiples  
 Pinze vascolari universali



DE BAKEY EV61034-21 -  
 EV61034-31



EV61034-21  
 21,5 cm  
 8 1/2"



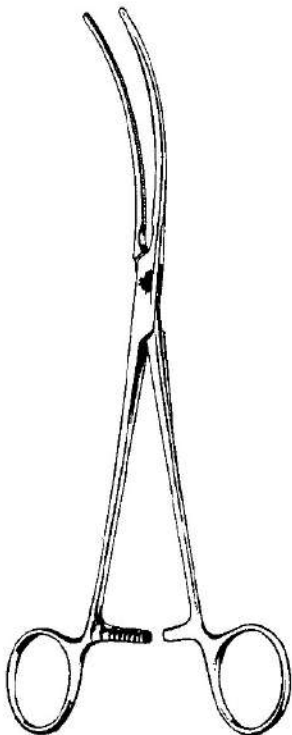
EV61034-23  
 23 cm  
 9"



EV61034-27  
 27 cm  
 10 1/2"



EV61034-31  
 31,5 cm  
 12 1/2"



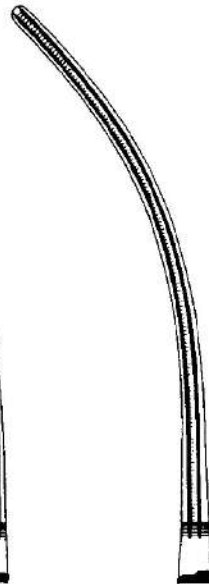
DE BAKEY EV61035-21 -  
 EV61035-31



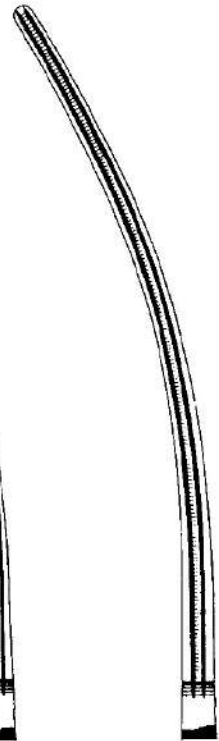
EV61035-21  
 21,5 cm  
 8 1/2"



EV61035-23  
 23 cm  
 9"

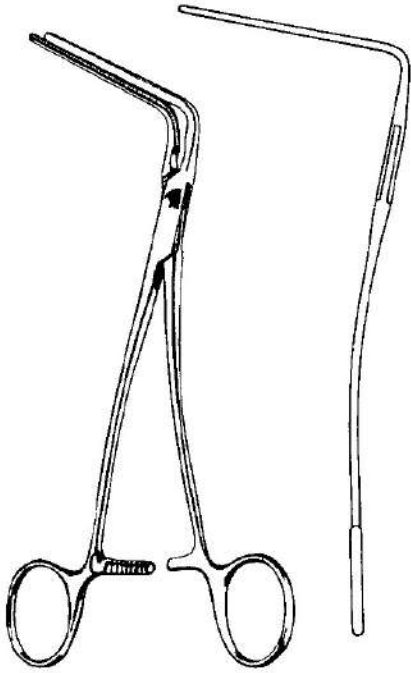


EV61035-27  
 27 cm  
 10 1/2"

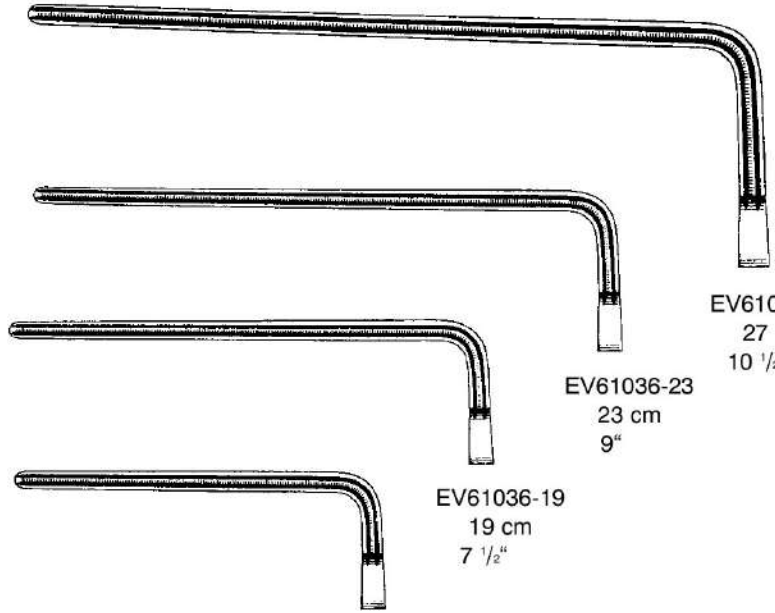


EV61035-31  
 31 cm  
 12 1/4"

Mehrzweck-Gefäßklemme  
 Multi purpose Vascular Clamps  
 Pinzas vasculares de usos multiples  
 Pinze vascolari universali



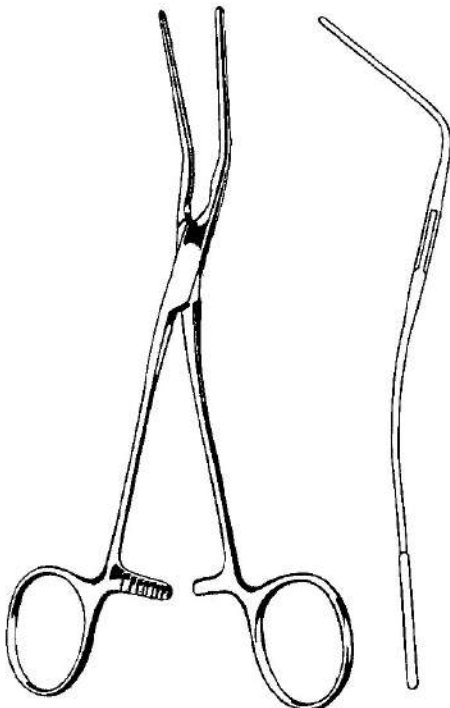
DE BAKEY EV61036-18 -  
 EV61036-27



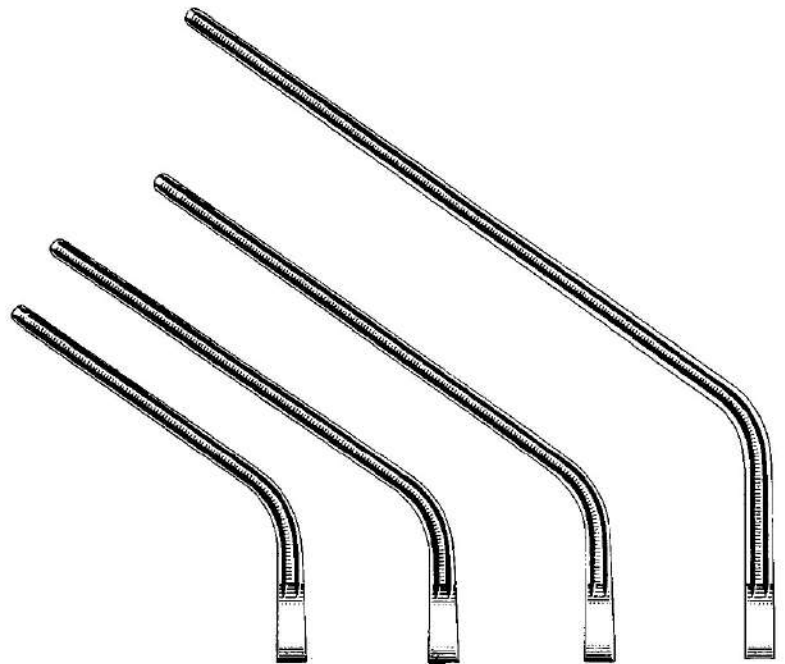
EV61036-18  
 18 cm  
 7"

EV61036-23  
 23 cm  
 9"

EV61036-27  
 27 cm  
 10 1/2"



DE BAKEY EV61037-20 -  
 EV61037-29



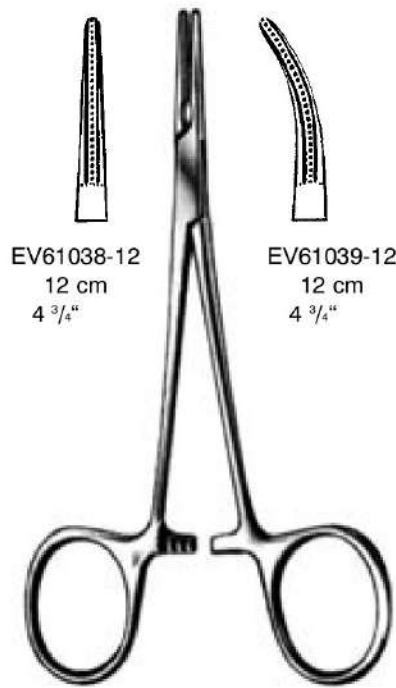
EV61037-20  
 20 cm  
 8"

EV61037-21  
 21 cm  
 8 1/4"

EV61037-25  
 25 cm  
 10"

EV61037-29  
 29 cm  
 11 1/2"

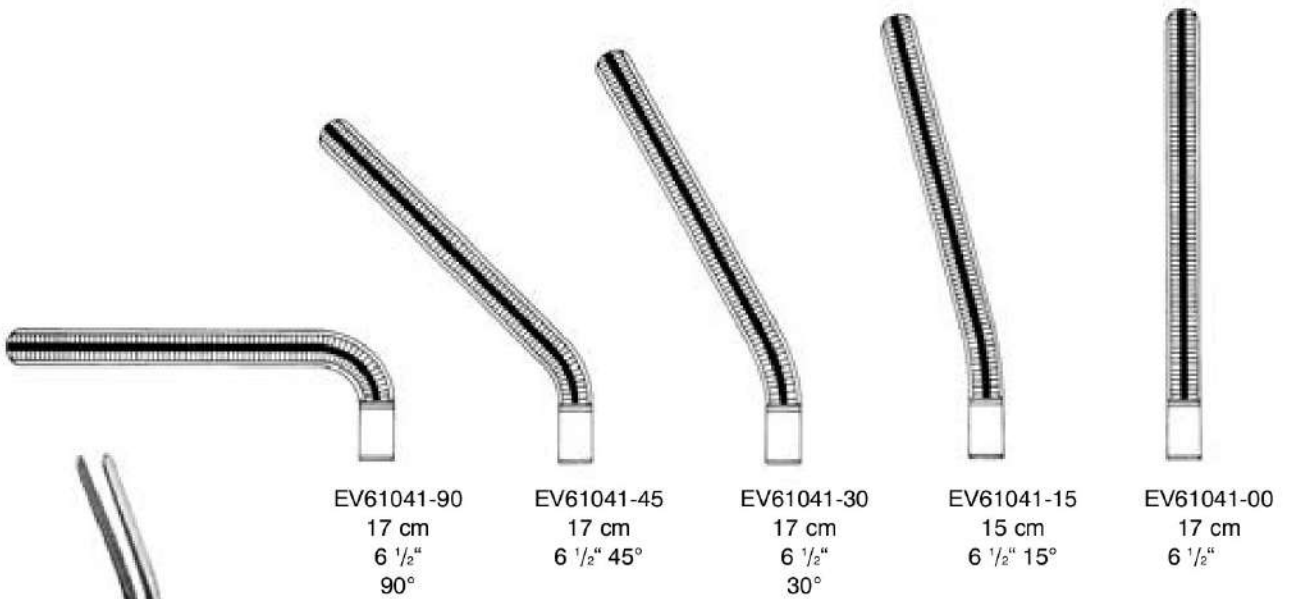
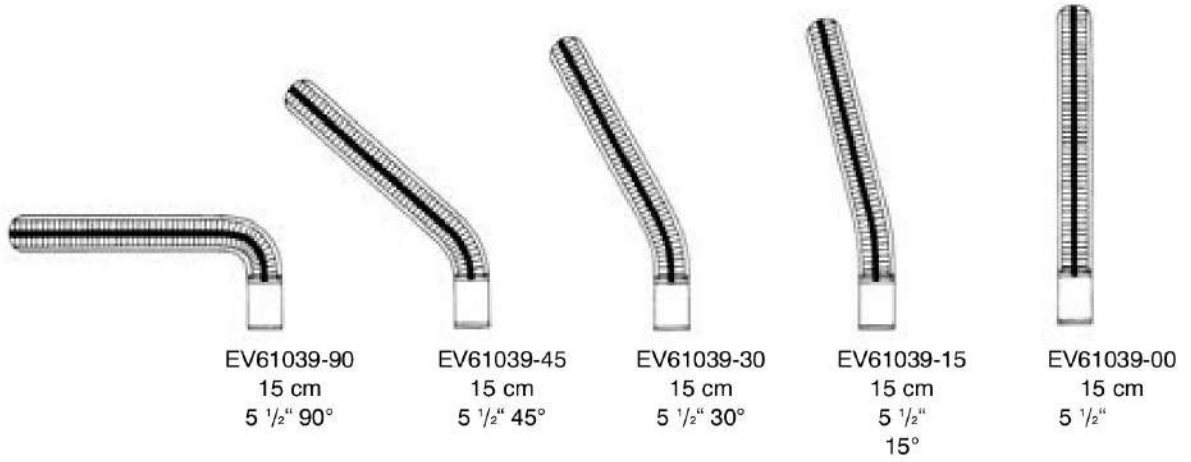
Arterienklemmen  
Hemostatic forceps  
Pinzas hemostáticas  
Pinze emostatiche



EV61038-12  
12 cm  
4 <sup>3</sup>/<sub>4</sub>"

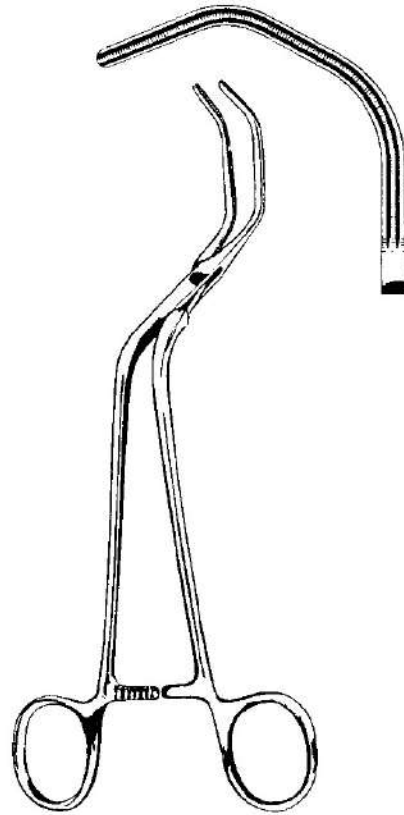
EV61039-12  
12 cm  
4 <sup>3</sup>/<sub>4</sub>"

DE BAKKEY-MOSQUITO  
EV61038-12 - EV61039-12

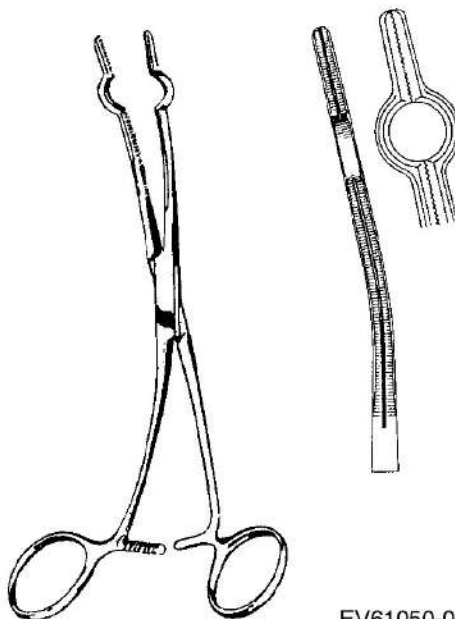


DARDIK

Aortaklemme, Katheterklemme  
 Aortic Clamps, Catheter Clamps  
 Pinzas-clamps para aorta, Pinzas para catéteres  
 Pinze per aorta, Pinze per cateteri



DIETRICH EV61040-21  
 21 cm, 8 1/4"



COOLEY EV61050-01 -  
 EV61050-07

| Charrière<br>(French) | Länge<br>Length<br>Largo<br>Lungo<br>cm |        |            |
|-----------------------|---|--------|------------|
| 24                    | 16                                      | 6 1/4" | EV61050-01 |
| 26                    | 16                                      | 6 1/4" | EV61050-02 |
| 28                    | 20                                      | 8"     | EV61050-03 |
| 30                    | 20                                      | 8"     | EV61050-04 |
| 32                    | 20                                      | 8"     | EV61050-05 |
| 36                    | 20                                      | 8"     | EV61050-07 |

EV61050-01 - EV61050-02 für Kinder  
 for children para niños per bambini

EV61050-03 - EV61050-07 für Erwachsene for adults  
 para adultos per adulti

Carotis-Shuntklemmen  
Carotid Shunt Clamps  
Pinzas para shunt carótido  
Pinze per carotide



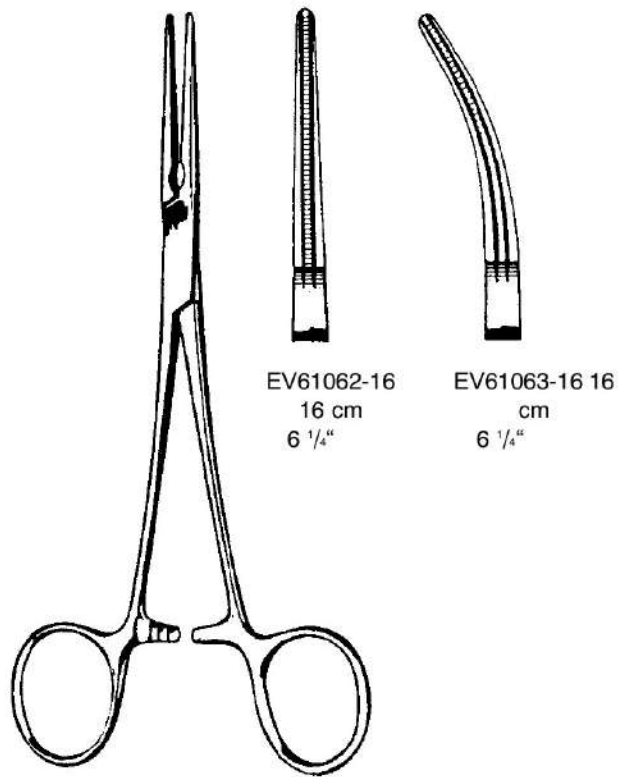
JAVID  
EV61045-18  
17,5 cm, 6.9"



JAVID  
EV61046-19  
18 cm, 7"



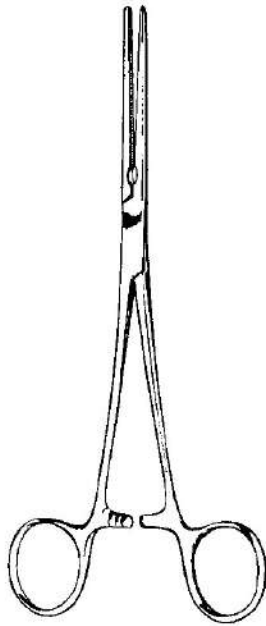
Arterienklemmen  
Haemostatic Forceps  
Pinzas hemostáticas  
Pinze emostatiche



DE BAKEY-RANKIN  
EV61062-16 - EV61063-16



Arterienklemmen  
Haemostatic Forceps  
Pinzas hemostáticas  
Pinze emostatiche



DE BAKEY-PEAN  
EV61138-14 - EV61138-20



EV61138-14  
14 cm  
5 1/2"



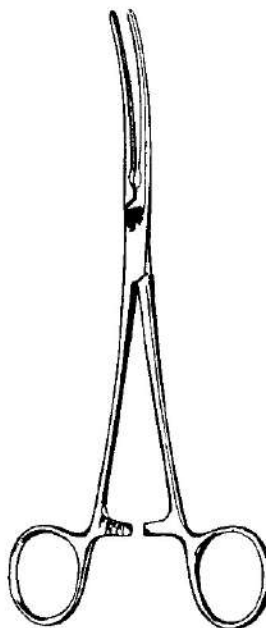
EV61138-16  
16 cm  
6 1/4"



EV61138-18  
18 cm  
7"



EV61138-20  
20 cm  
8"



DE BAKEY-PEAN  
EV61139-14 - EV61139-20



EV61139-14  
14 cm  
5 1/2"



EV61139-16  
16 cm  
6 1/4"

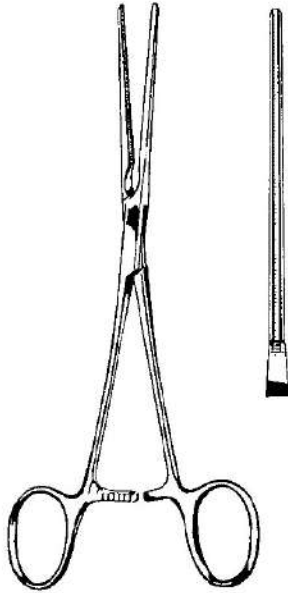


EV61139-18  
18 cm  
7"

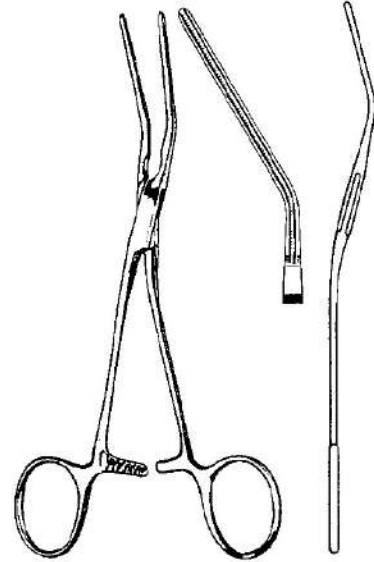


EV61139-20  
20 cm  
8"

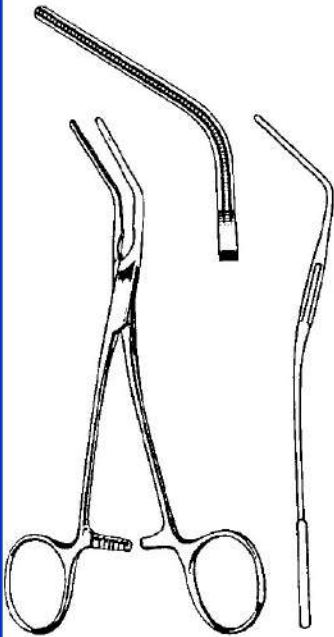
Mehrzweck-Gefäßklemmen  
 Multi purpose Vascular Clamps  
 Pinzas vasculares de usos múltiples  
 Pinze vascolari universali



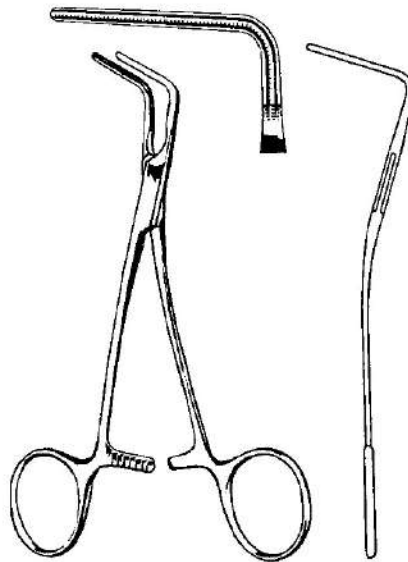
DE BAKEY  
 EV61140-17  
 17 cm, 6 <sup>3</sup>/<sub>4</sub>"



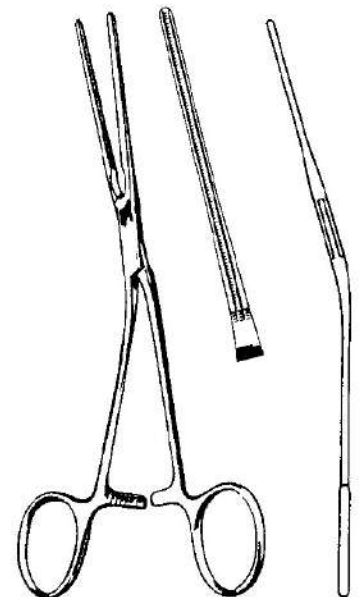
DE BAKEY  
 EV61141-16  
 16 cm, 6 <sup>1</sup>/<sub>4</sub>"



DE BAKEY  
 EV61143-15  
 15 cm, 6"

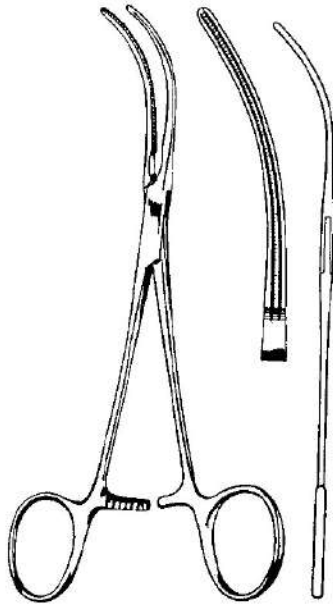


DE BAKEY  
 EV61145-15  
 15 cm, 6"

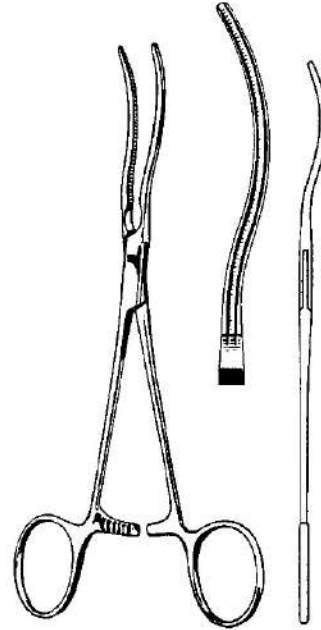


DE BAKEY  
 EV61147-17  
 17 cm, 6 <sup>3</sup>/<sub>4</sub>"

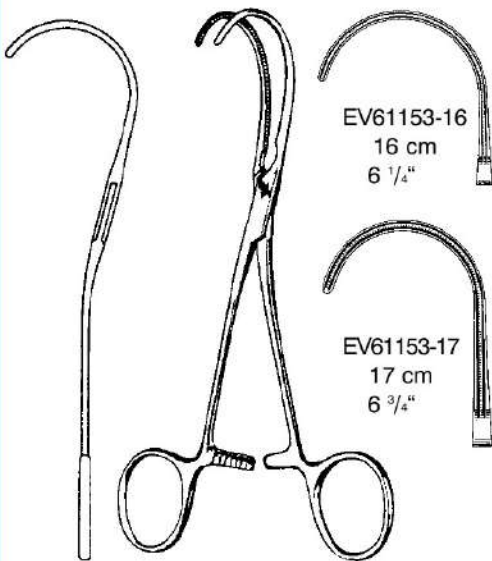
Mehrzweck-Gefäßklemmen, Anastomosenklemmen  
 Multi purpose Vascular Clamps, Anastomosis Clamps  
 Pinzas vasculares de usos múltiples, Pinzas para anastomosis  
 Pinze vascolari universali, Pinze per anastomosi



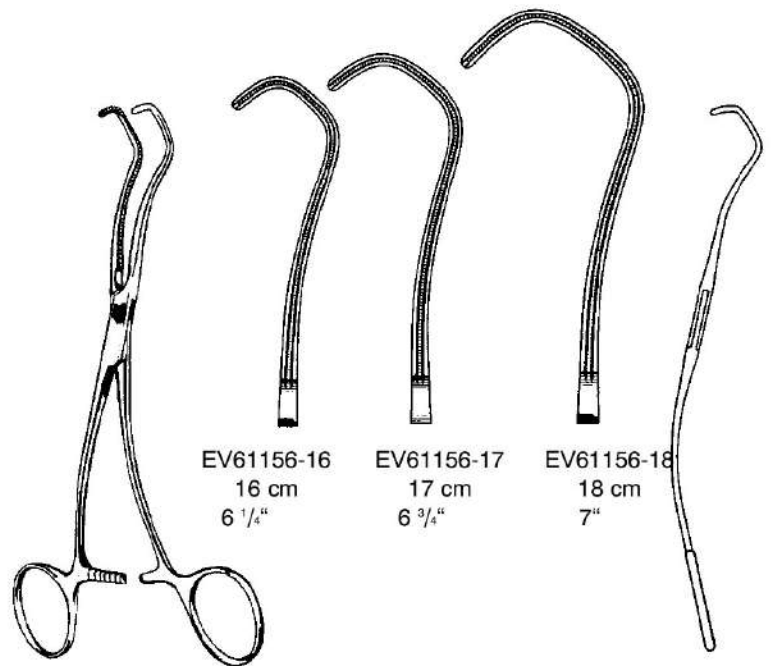
GLOVER  
 EV61149-17  
 17 cm, 6 3/4"



GLOVER  
 EV61151-17  
 17 cm, 6 3/4"

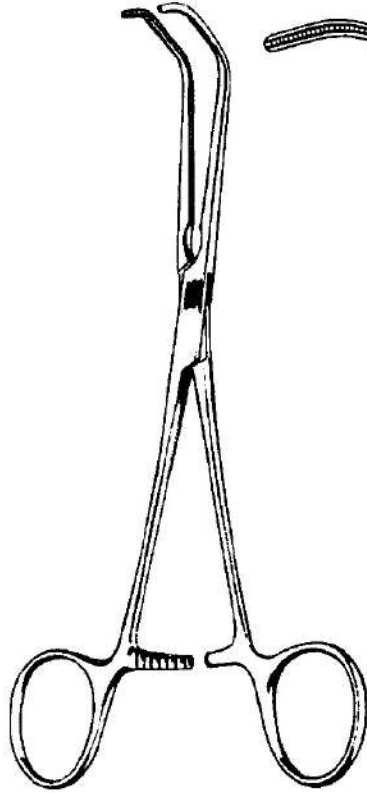


DE BAKEY EV61153-16 -  
 EV61153-17

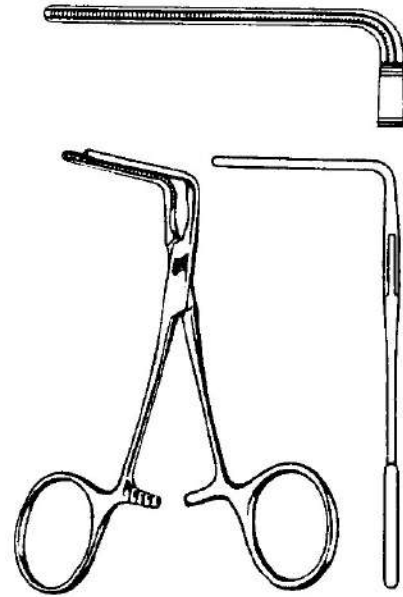
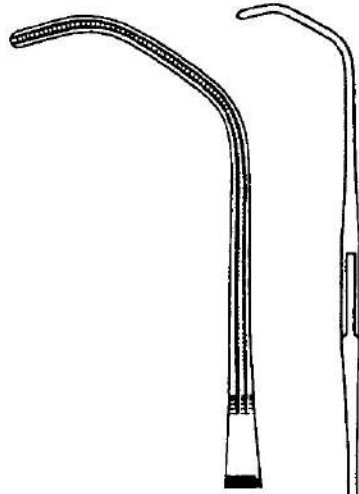


DERRA EV61156-16  
 - EV61156-18

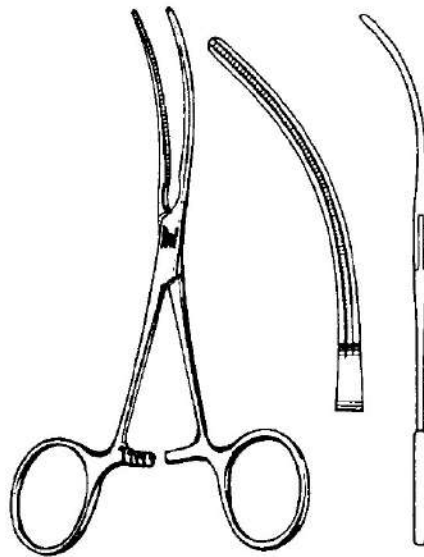
Anastomosenklemmen, Kinder-Gefäßklemmen  
 Anastomosis Clamps, Pediatric Vascular Clamps  
 Pinzas para anastomosis, Pinzas vasculares pediátricas  
 Pinze per anastomosi, Pinze vascolari pediatriche



DE BAKEY-BECK  
 EV61157-17 17 cm, 6 3/4"

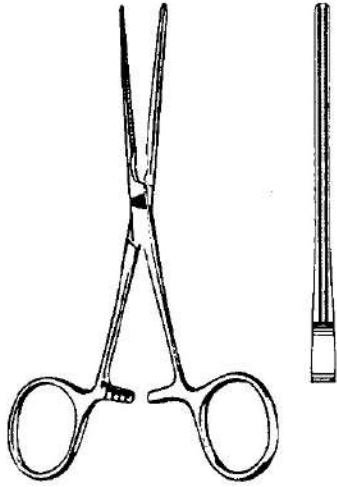


DE BAKEY  
 EV61158-10 10 cm, 4"

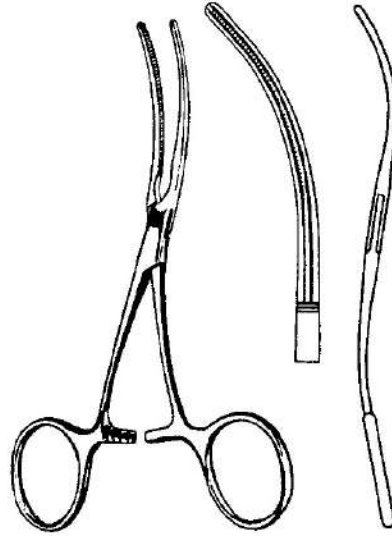


DE BAKEY EV61158-11  
 11 cm, 4 3/8"

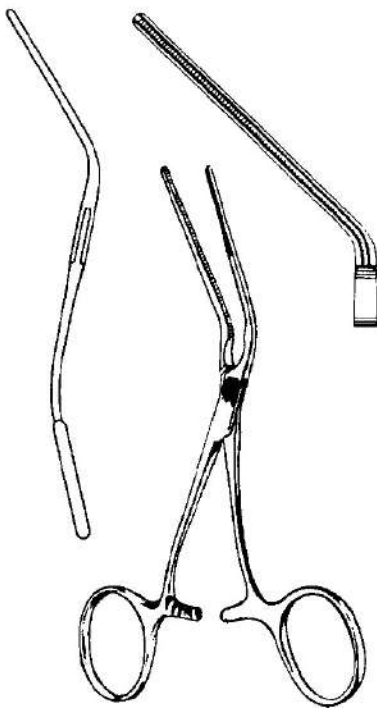
Kinder-Gefäßklemmen, Profundaklemmen  
 Pediatric Vascular Clamps, Profunda Clamps  
 Pinzas vasculares pediátricas, Pinzas para la profunda  
 Pinze vascolari pediatriche, Pinze profunda



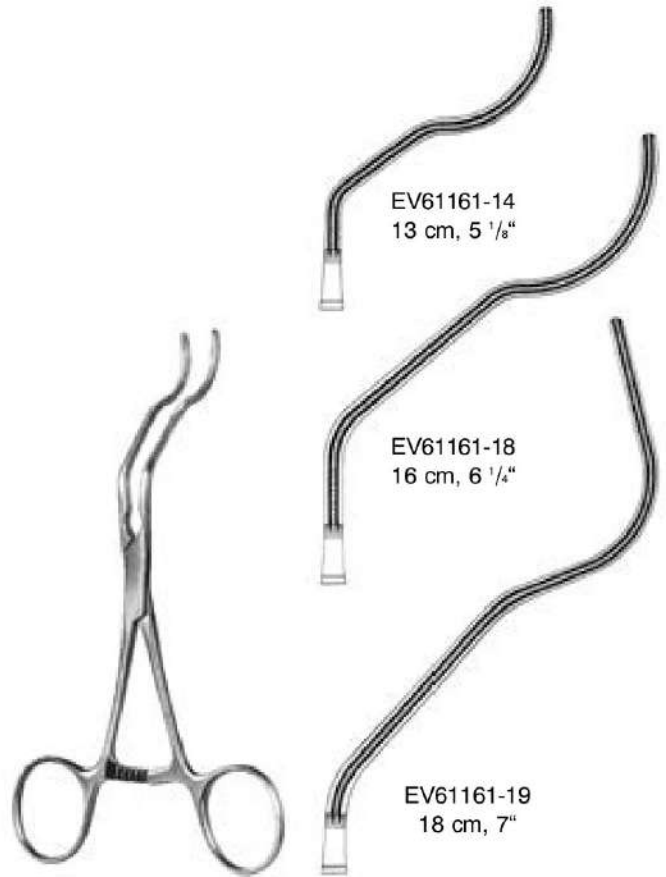
DE BAKEY EV61158-12  
 12 cm, 4 <sup>3</sup>/<sub>4</sub>"



DE BAKEY EV61159-12  
 11,5 cm, 4 <sup>1</sup>/<sub>2</sub>"



DE BAKEY EV61159-13  
 13 cm, 5 <sup>1</sup>/<sub>8</sub>"



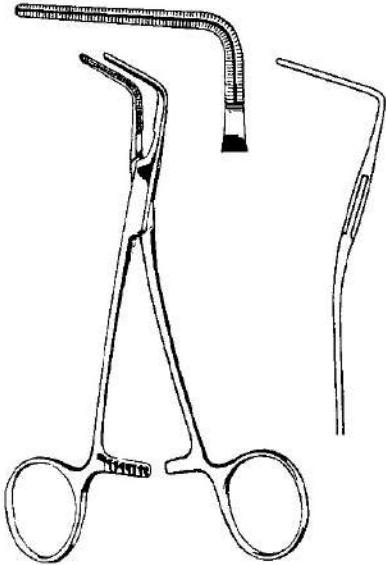
GREGORY

EV61161-14  
 13 cm, 5 <sup>1</sup>/<sub>8</sub>"

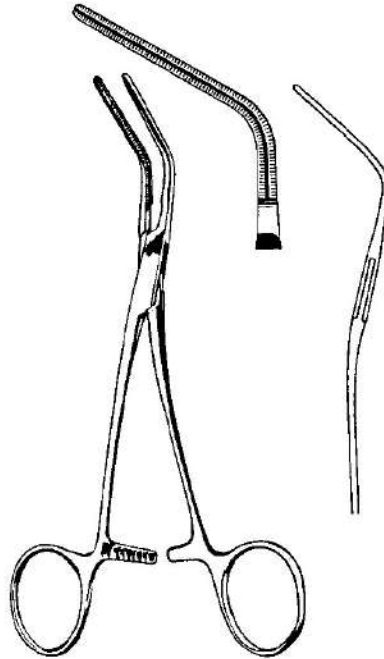
EV61161-18  
 16 cm, 6 <sup>1</sup>/<sub>4</sub>"

EV61161-19  
 18 cm, 7"

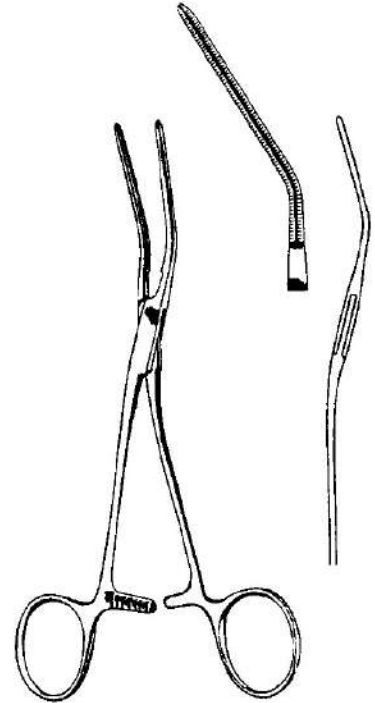
Mehrzweck-Gefäßklemmen  
 Multi purpose Vascular Clamps  
 Pinzas vasculares de usos múltiples  
 Pinze vascolari universali



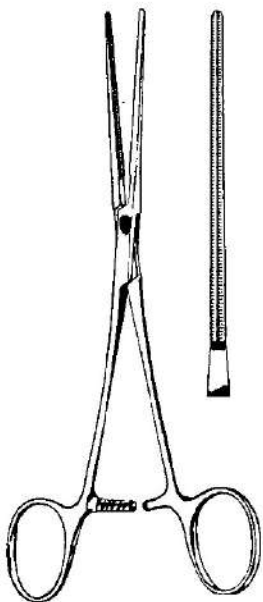
COOLEY  
 EV61172-15  
 15 cm, 6"



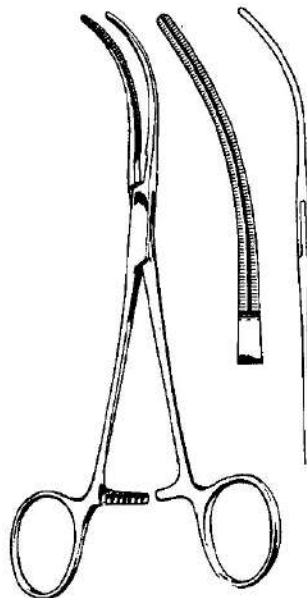
COOLEY  
 EV61173-16  
 15,5 cm, 6"



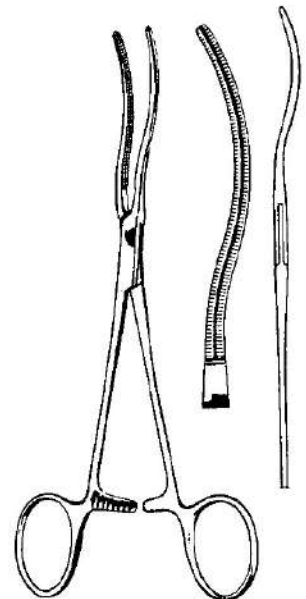
COOLEY  
 EV61174-17  
 17 cm, 6 3/4"



COOLEY  
 EV61175-17  
 17 cm, 6 3/4"



COOLEY  
 EV61176-17  
 17 cm, 6 3/4"



COOLEY  
 EV61177-17  
 17 cm, 6 3/4"

Anastomosenklemmen  
 Anastomosis Clamps  
 Pinzas para anastomosis  
 Pinze per anastomosi



COOLEY-DERRA  
 EV61178-16 -  
 EV61179-18



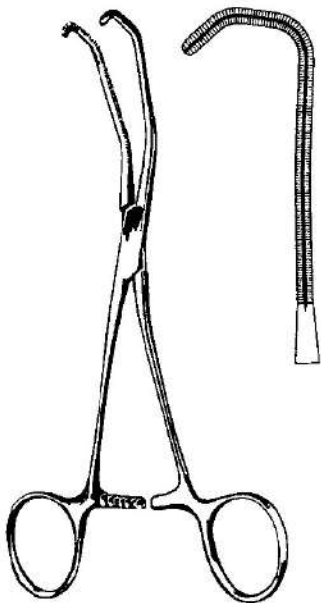
EV61178-16  
 16 cm  
 6 1/4"



EV61178-17  
 17 cm  
 6 3/4"



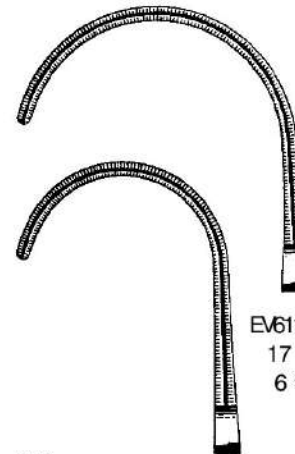
EV61179-18  
 18 cm  
 7"



COOLEY  
 EV61180-17  
 17 cm, 6 3/4"



COOLEY EV61187-16 -  
 EV61187-17



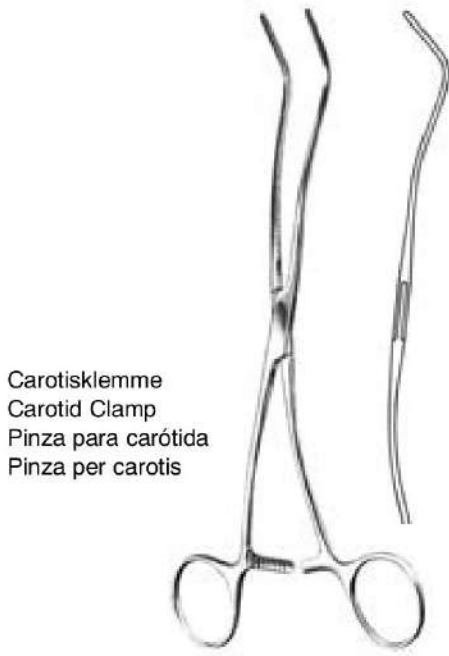
EV61187-17  
 17 cm  
 6 3/4"

EV61187-16  
 16 cm  
 6 1/4"





Anastomosenklemmen, Mehrzweck-Gefäßklemme  
 Anastomosis Clamp, Multi purpose Vascular Clamps  
 Pinza clamp para iliac y anastomosis, Pinzas vasculares de usos multiples  
 Pinze anastomosi, Pinze vascolari universali

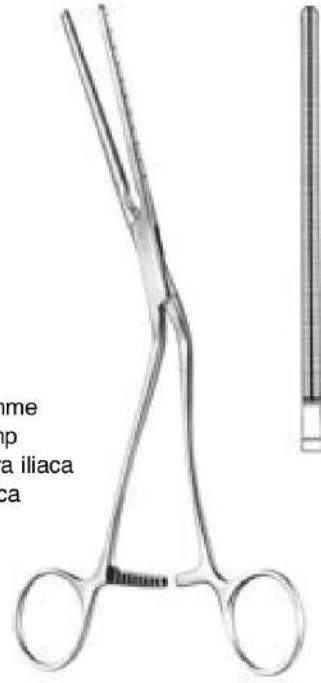


Carotisklemme  
 Carotid Clamp  
 Pinza para carótida  
 Pinza per carotis

COOLEY EV61188-20  
 20 cm, 8"



Iliacaklemme  
 Iliac Clamp  
 Pinza para iliaca  
 Pinza iliaca



COOLEY  
 EV61189-21 21 cm, 8 1/4"



BECK EV61190-17  
 17 cm, 6 3/4"

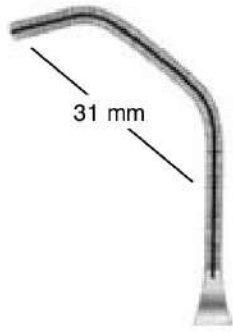


COOLEY EV61191-16  
 16 cm, 6 1/4"



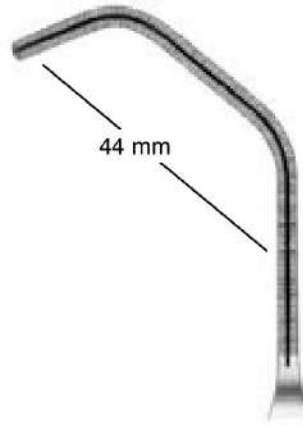
COOLEY EV61192-17  
 17 cm, 6 3/4"

Anastomosenklemmen  
Anastomosis Clamp  
Pinza clamp para iliac y anastomosis  
Pinze anastomosi



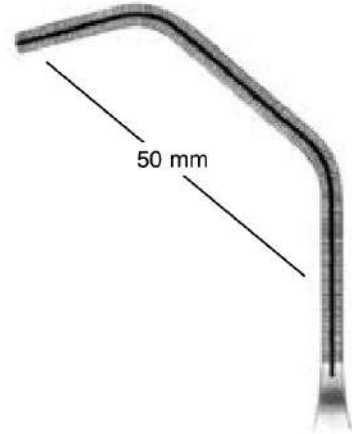
31 mm

EV61193-01  
20,5 cm, 8"



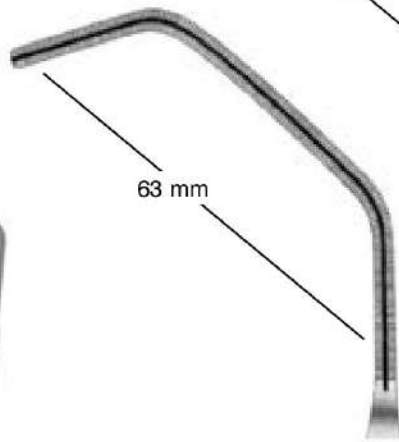
44 mm

EV61193-02  
26 cm, 10 1/4"



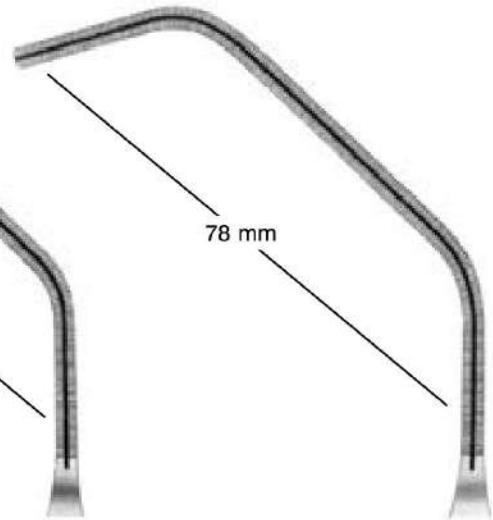
50 mm

EV61193-03  
26,5 cm, 10 1/2"



63 mm

EV61193-04  
26,5 cm, 10 1/2"

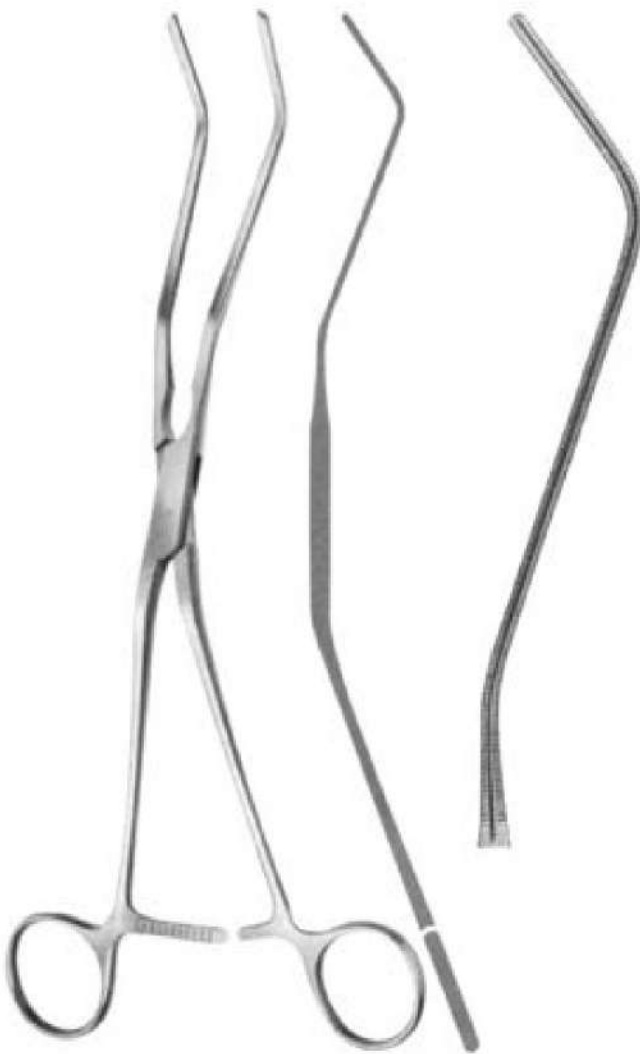


78 mm

EV61193-05  
27,5 cm, 10 3/4"



COOLEY



COOLEY EV61194-26  
26 cm, 10 <sup>3</sup>/<sub>4</sub>"



COOLEY EV61195-28  
28,5 cm, 11 <sup>1</sup>/<sub>4</sub>"

Aortaklemme  
Aortic Clamps  
Pinzas aórticas  
Pinze per aorta



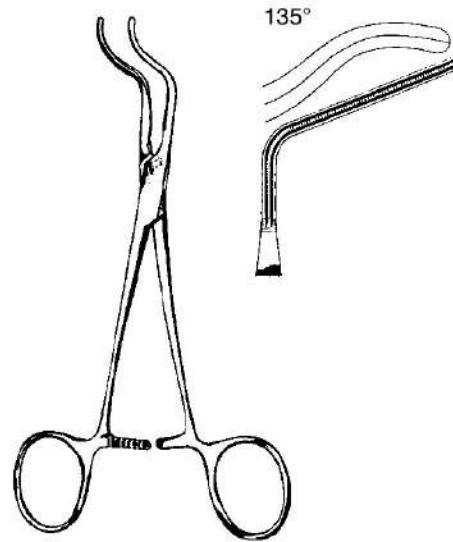
COOLEY EV61195-32  
32 cm, 12 <sup>3</sup>/<sub>4</sub>"

Anastomosenklemmen  
Anastomosis Clamp  
Pinza clamp para iliac y anastomosis  
Pinze anastomosi

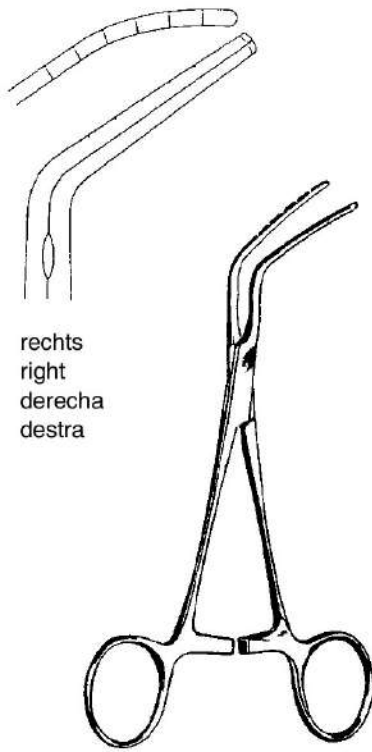


COOLEY EV61196-26  
26 cm, 10 1/4"

Kinder-Aortaklemme  
 Pediatric Aortic Clamps  
 Pinza aórticas pediátricas  
 Pinze per aorta pediatriche

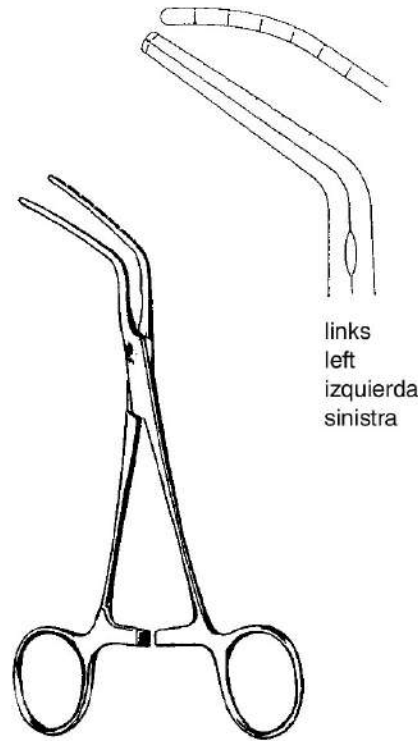


SUBRAMANIAN-MINIATURE  
 EV61259-15 15,5 cm, 6"



rechts  
 right  
 derecha  
 destra

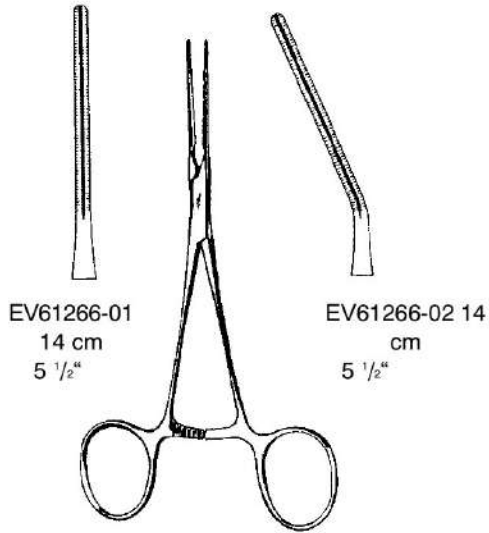
SUBRAMANIAN  
 EV61261-16 16 cm, 6 1/4"



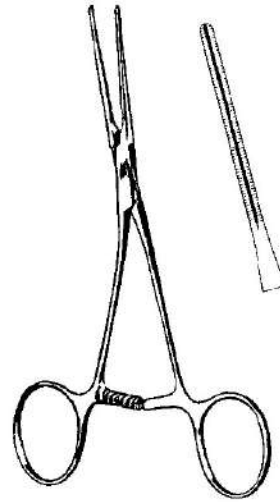
links  
 left  
 izquierda  
 sinistra

SUBRAMANIAN  
 EV61263-16 16 cm, 6 1/4"

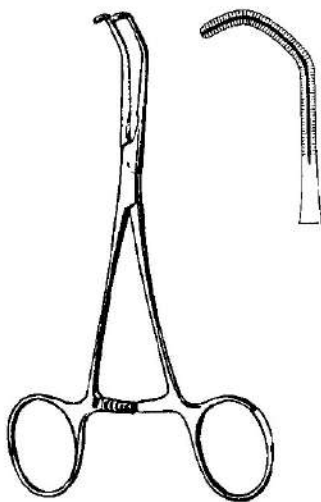
Kinder-Gefäßklemmen  
 Pediatric Vascular Clamps  
 Pinzas vasculares pediátricas  
 Pinze vascolari pediatriche



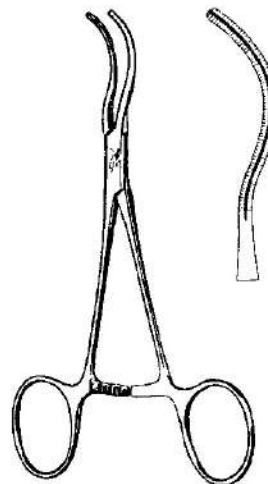
COOLEY EV61266-01 -  
 EV61266-02 14 cm, 5  
 1/2"



COOLEY EV61266-03  
 14 cm, 5 1/2"

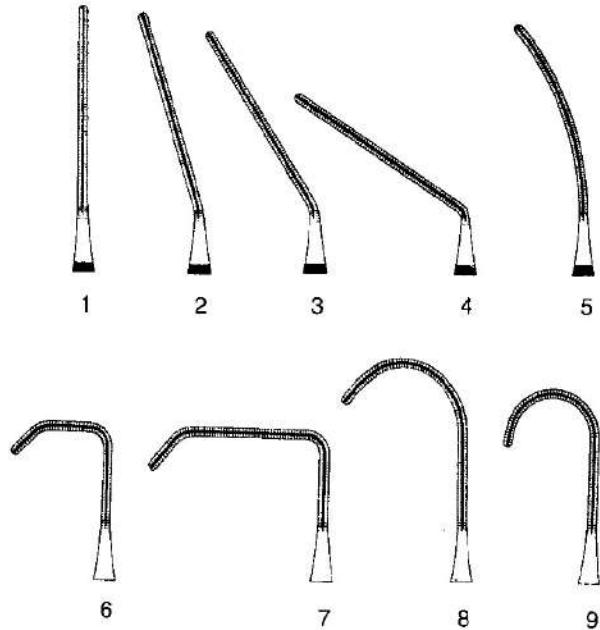
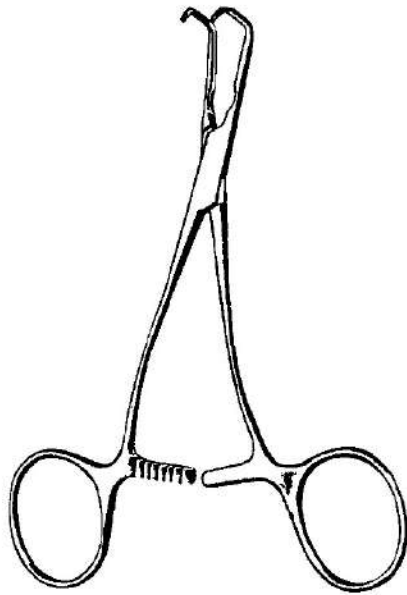


COOLEY EV61266-04  
 14 cm, 5 1/2"



COOLEY EV61266-05  
 14 cm, 5 1/2"

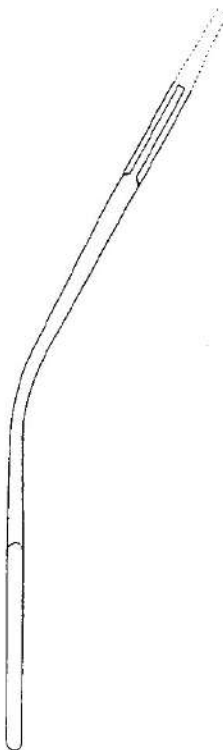
Kinder-Gefäßklemmen  
 Pediatric Vascular Clamps  
 Pinzas vasculares pediátricas  
 Pinze vascolari pediatriche



| Fig. | gerade<br>straight<br>rectas<br>rette |
|------|---------------------------------------|
| 1    | EV61372-01<br>14 cm, 5 1/2"           |
| 2    | EV61372-02<br>14 cm, 5 1/2"           |
| 3    | EV61372-03<br>14 cm, 5 1/2"           |
| 4    | EV61372-04<br>13 cm, 5 1/8"           |
| 5    | EV61372-05<br>14 cm, 5 1/2"           |
| 6    | EV61372-06<br>13 cm, 5 1/8"           |
| 7    | EV61372-07<br>13 cm, 5 1/8"           |
| 8    | EV61372-08<br>14 cm, 5 1/2"           |
| 9    | EV61372-09<br>13,5 cm, 5 1/4"         |



| Fig. | stark abgewinkelt<br>strongly angled<br>ramas anguladas<br>forte angolata |
|------|---|
| 1    | EV61373-01<br>14 cm, 5 1/2"   |
| 2    | EV61373-02<br>14 cm, 5 1/2"   |
| 3    | EV61373-03<br>14 cm, 5 1/2"   |
| 4    | EV61373-04<br>13 cm, 5 1/8"   |
| 5    | EV61373-05<br>14 cm, 5 1/2"   |
| 6    | EV61373-06<br>13 cm, 5 1/8"   |
| 7    | EV61373-07<br>13 cm, 5 1/8"   |
| 8    | EV61373-08<br>14 cm, 5 1/2"   |
| 9    | EV61373-09<br>13,5 cm, 5 1/4"   |



| Fig. | abgewinkelt<br>angled<br>acodadas<br>angolate |
|------|---|
| 1    | EV61374-01<br>14 cm, 5 1/2"                   |
| 2    | EV61374-02<br>14 cm, 5 1/2"                   |
| 3    | EV61374-03<br>14 cm, 5 1/2"                   |
| 4    | EV61374-04<br>13 cm, 5 1/8"                   |
| 5    | EV61374-05<br>14 cm, 5 1/2"                   |
| 6    | EV61374-06<br>13 cm, 5 1/8"                   |
| 7    | EV61374-07<br>13 cm, 5 1/8"                   |
| 8    | EV61374-08<br>14 cm, 5 1/2"                   |
| 9    | EV61374-09<br>13,5 cm, 5 1/4"                 |





Clipanlegezangen für die offene Chirurgie 25° aufgebogen  
 Clip Appliers for open Surgery 25° upcurved  
 Pinza applicadora de clips para cirugía abierta con ángulo de 25°  
 Pinza applicatore clips per chirurgia aperto, curvo in alto 25°



15 cm, 6"

**Horizon**

EV61460-15 Small gelb / yellow / jaune/ amarillo/ giallo  
 EV61461-15 Medium blau / blue / bleu / azul / blu

**SLS Clips**

EV61464-15 Micro weiss / white / blanc / blanco / bianco  
 EV61465-15 Small gelb / yellow / jaune/ amarillo/ giallo  
 EV61466-15 Small medium lila / lilac / lilas / lila / lilla  
 EV61467-15 Medium blau / blue / bleu / azul / blu

**Ethicon**

EV61470-15 Small blau / blue / bleu / azul / blu  
 EV61471-15 Medium weiss / white / blanc / blanco / bianco

**Pilling**

EV61481-15 Small gelb / yellow / jaune / amarillo / giallo  
 EV61482-15 Medium blau / blue / bleu / azul / blu

**Horizon**

EV61460-19 Small gelb / yellow / jaune / amarillo / giallo  
 EV61461-19 Medium blau / blue / bleu / azul / blu  
 EV61462-19 Medium Large grün / green / verde / verde  
 EV61463-19 Large orange / naranja / arancione

**SLS Clips**

EV61464-19 Micro weiss / white / blanc / blanco / bianco  
 EV61465-19 Small gelb / yellow/ jaune / amarillo / giallo  
 EV61466-19 Small medium lila / lilac / lilas / lila / lilla  
 EV61467-19 Medium blau / blue / bleu / azul / blu  
 EV61468-19 Medium Large grün / green / verde / verde  
 EV61469-19 Large orange / naranja / arancione

**Ethicon**

EV61470-19 Small blau / blue / bleu / azul / blu  
 EV61471-19 Medium weiss / white / blanc / blanco / bianco  
 EV61472-19 Medium Large grün / green / verde / verde  
 EV61473-19 Large gelb / yellow / jaune / amarillo / giallo

**Pilling**

EV61481-19 Small gelb / yellow / jaune / amarillo / giallo  
 EV61482-19 Medium blau / blue / bleu / azul / blu  
 EV61484-19 Medium Large grün / green / verde / verde  
 EV61483-19 Large orange / naranja / arancione



19 cm, 7 1/2"

Clipanlagezangen für die offene Chirurgie 25° aufgebogen  
Clip Appliers for open Surgery 25° upcurved  
Pinza aplicadora de clips para cirugía abierta con ángulo de 25°  
Pinza applicatore clips per chirurgia aperto, curvo in alto 25°



28 cm, 11"

**Horizon**

EV61461-28 Medium blau / blue / bleu / azul / blu  
EV61462-28 Medium Large grün / green / verde / verde  
EV61463-28 Large orange / naranja / arancione

**SLS Clips**

EV61464-28 Micro weiss / white / blanco / bianco  
EV61465-28 Small gelb / yellow / jaune / amarillo / giallo  
EV61466-28 Small medium lila / lilac / lilas / lila / lilla  
EV61467-28 Medium blau / blue / bleu / azul / blu  
EV61468-28 Medium Large grün / green / verde / verde  
EV61469-28 Large orange / naranja / arancione

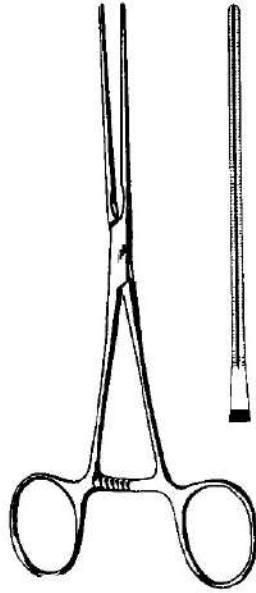
**Ethicon**

EV61471-28 Medium weiss / white / blanco / bianco  
EV61472-28 Medium Large grün / green / verde / verde  
EV61473-28 Large gelb / yellow / jaune / amarillo / giallo

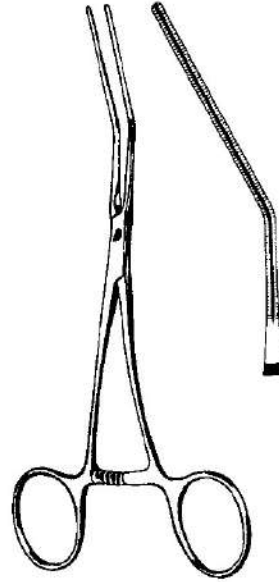
**Pilling**

EV61482-28 Medium blau / blue / bleu / azul / blu  
EV61484-28 Medium Large grün / green / verde / verde  
EV61483-28 Large orange / naranja / arancione

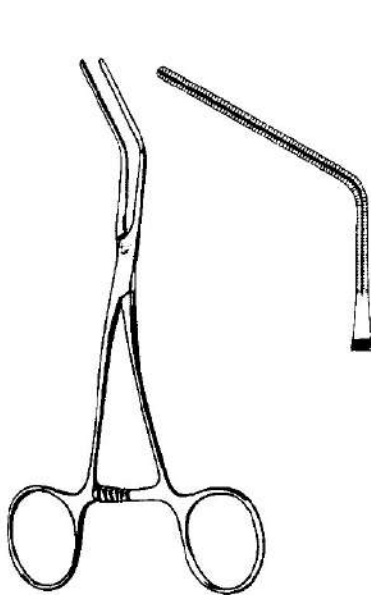
Kinder-Gefäßklemmen  
Pediatric Vascular Clamps  
Pinzas vasculares pediátricas  
Pinze vascolari pediatriche



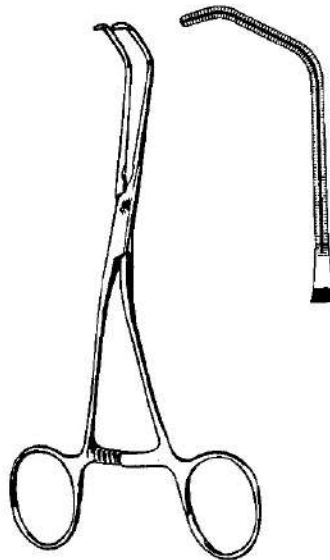
EV61488-16  
16,5 cm, 6 1/2"



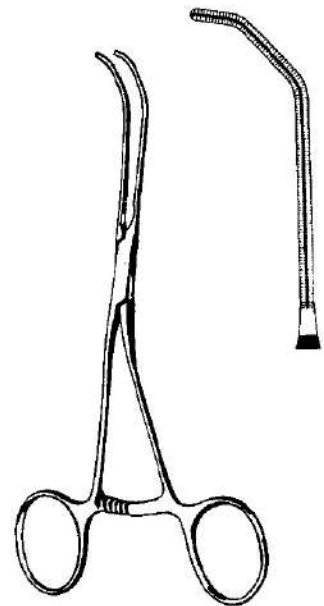
EV61489-16  
16 cm, 6 1/4"



EV61490-15  
15 cm, 6"



EV61491-15  
15 cm, 6"



EV61492-16  
15,5 cm, 6"

Neonatal-Gefäßklemmen  
 Neonatal Vascular Clamps  
 Pinzas vasculares para recién nacidos  
 Pinze vascolari per neonati



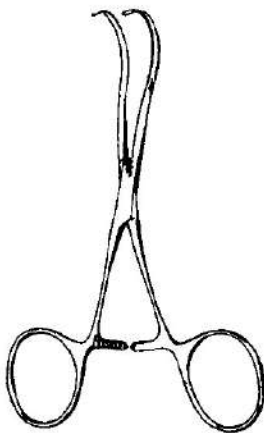
EV61493-01  
 13 cm  
 5 1/8"



EV61493-02  
 13 cm  
 5 1/8"



EV61493-03  
 11 cm  
 4 3/8"



CASTANEDA  
 EV61493-01 -  
 EV61495-04



EV61495-01  
 12 cm  
 4 3/4"



EV61495-02  
 12 cm  
 4 3/4"

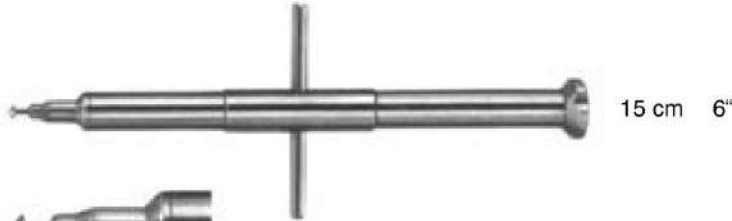


EV61495-03  
 12 cm  
 4 3/4"



EV61495-04  
 12 cm  
 4 3/4"

Aortenstanzen, Tourniquets  
Aorta punches, Tourniquets  
Trefina para aorta, Tourniquets  
Trefino per Aorta, Tornichetti



EV61700-01  
EV61710-01  
Mandrin alleine  
Guide only Guida  
sola

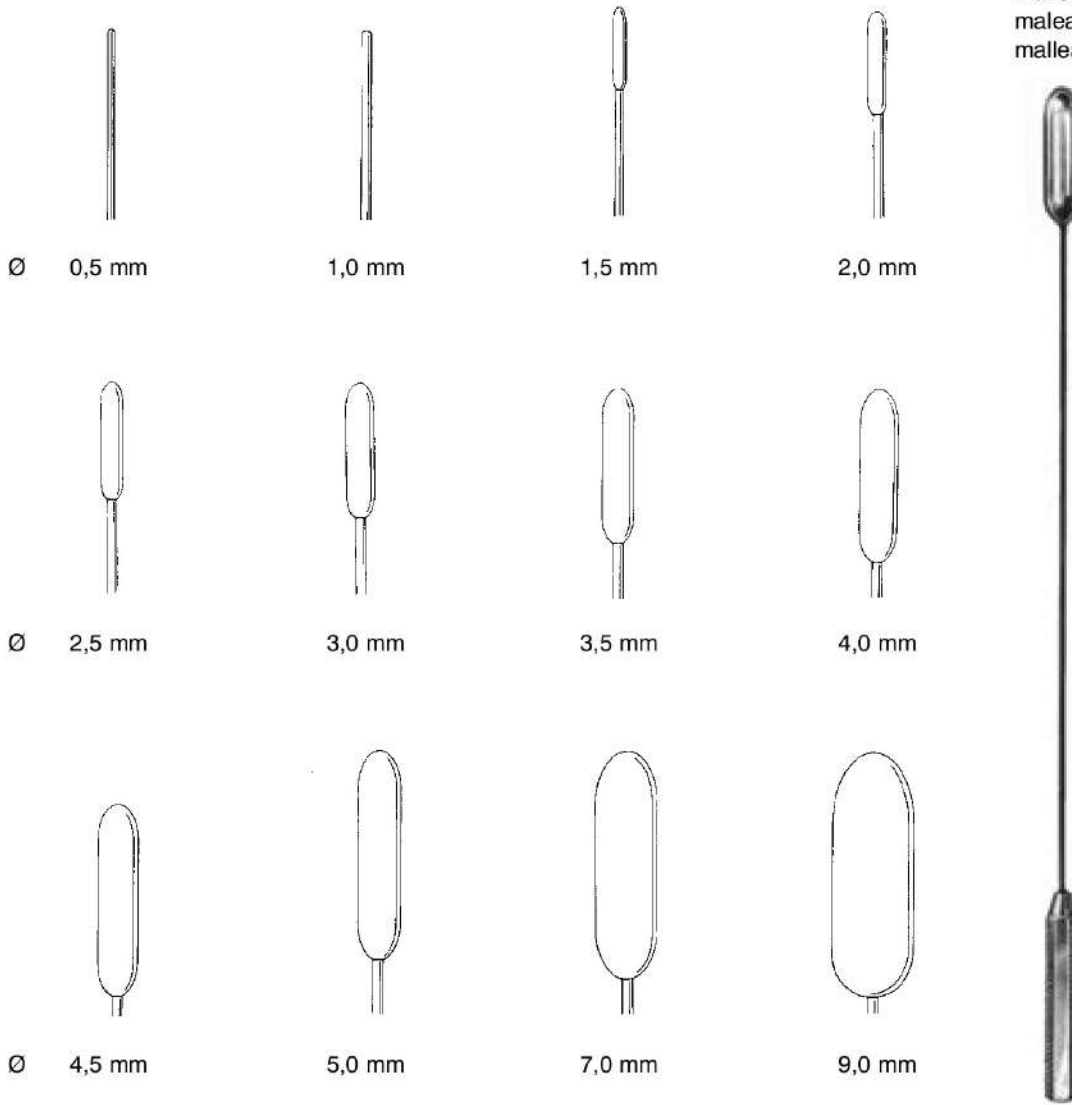


RUMEL-BELMONT  
EV61700-33 3,2 mm Ø  
EV61710-33 6,4 mm Ø  
33 cm, 13" flex-  
ibel, flexible,  
flexible, flessibile

Gefäß-Dilatatoren  
 Vascular Dilators  
 Dilatadores vasculares  
 Dilattori vascolari

GERNAL SURGICAL

biegsam  
 malleable  
 maleables  
 malleabile

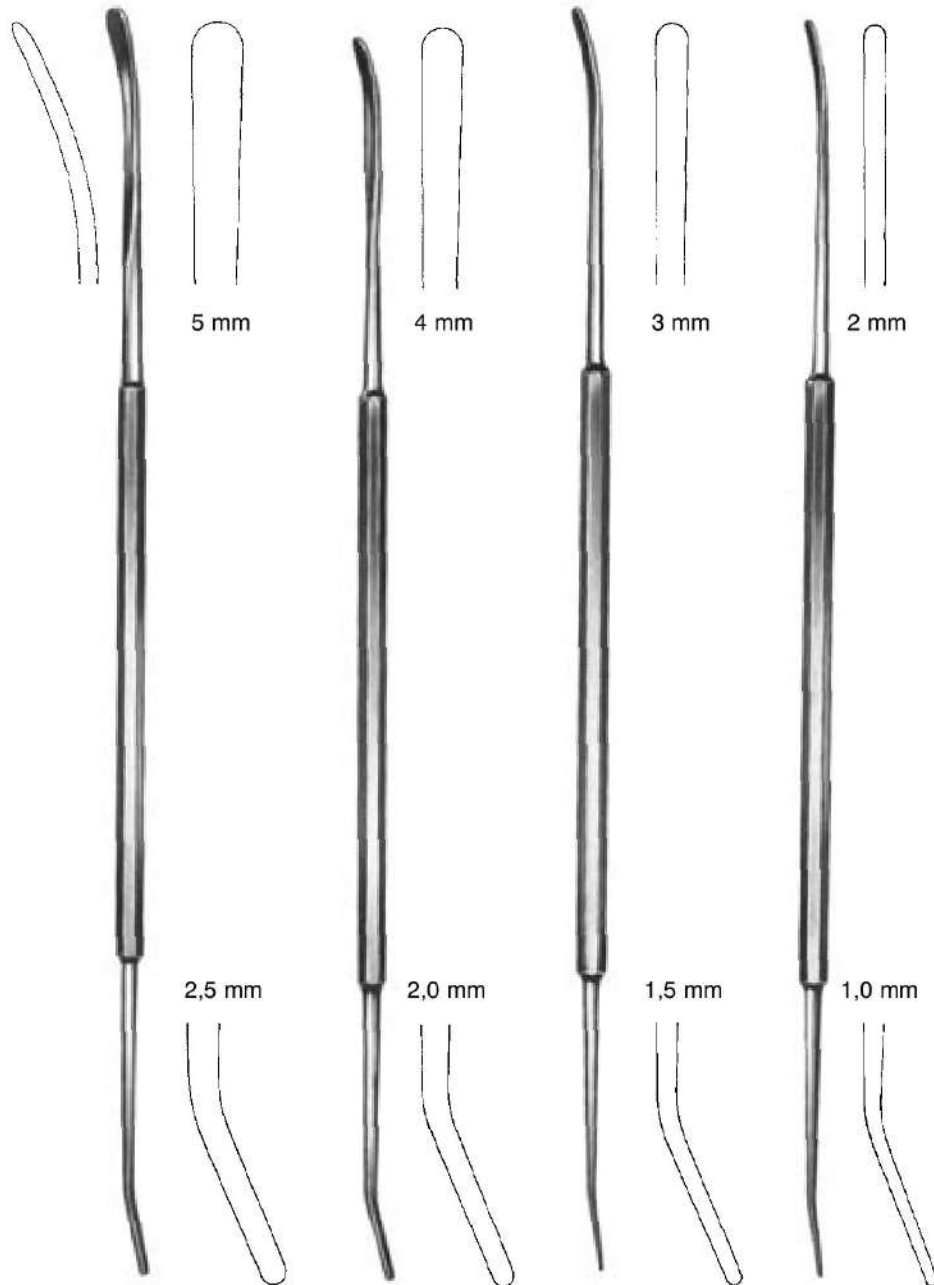


|   |        |        |        |        |
|---|--------|--------|--------|--------|
| Ø | 0,5 mm | 1,0 mm | 1,5 mm | 2,0 mm |
| Ø | 2,5 mm | 3,0 mm | 3,5 mm | 4,0 mm |
| Ø | 4,5 mm | 5,0 mm | 7,0 mm | 9,0 mm |

DE BAKEY

|               |      |                |
|---------------|------|----------------|
| 19 cm, 7 1/2" | Ø mm | 35 cm, 13 3/4" |
| EV61810-05    | 0,5  | EV61820-05     |
| EV61810-10    | 1,0  | EV61820-10     |
| EV61810-15    | 1,5  | EV61820-15     |
| EV61810-20    | 2,0  | EV61820-20     |
| EV61810-25    | 2,5  | EV61820-25     |
| EV61810-30    | 3,0  | EV61820-30     |
| EV61810-35    | 3,5  | EV61820-35     |
| EV61810-40    | 4,0  | EV61820-40     |
| EV61810-45    | 4,5  | EV61820-45     |
| EV61810-50    | 5,0  | EV61820-50     |
| EV61810-70    | 7,0  | EV61820-70     |
| EV61810-90    | 9,0  | EV61820-90     |

Gefäßdissektoren  
Vascular Dissectors  
Disecadores vasculares  
Dissettori vascolari



ROBB  
24 cm, 9 1/2"

Fig. 1  
EV61910-01

Fig. 2  
EV61910-02

Fig. 3  
EV61910-03

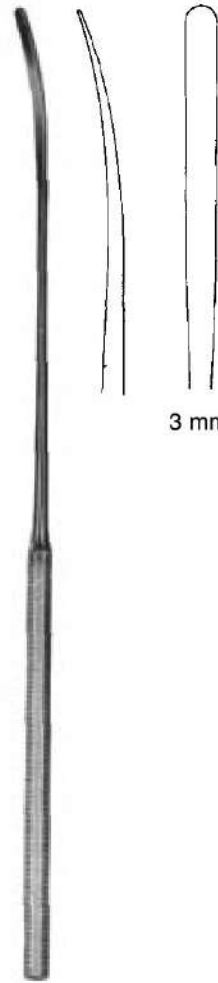
Fig. 4  
EV61910-04



EV61920-14  
 14 cm 5 1/2"



EV61920-23  
 23,5 cm 9 1/4"



3 mm

stumpf  
 blunt  
 roma  
 smussa

EV61930-18  
 18,5 cm, 7 1/4"

EV61930-21  
 21,5 cm, 8 1/2"

stumpf  
 blunt  
 roma  
 smussa



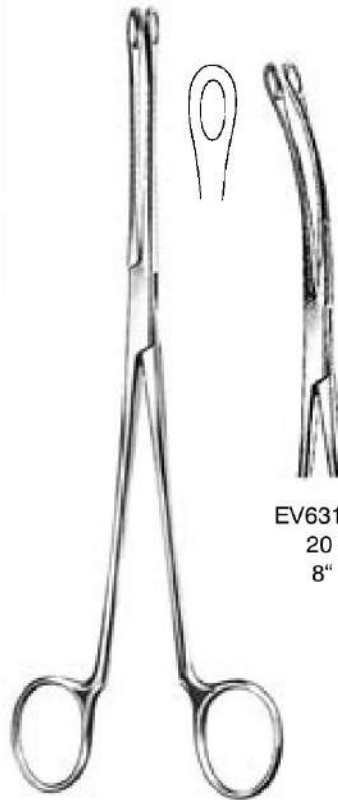


DESJARDINS  
 23 cm, 9"

Fig. 1  
 EV63101-23



Fig. 2  
 EV63103-23



BLAKE  
 EV63106-20 20 cm, 8"

EV63107-20  
 20 cm  
 8"



MAYO-BLAKE EV63110-20  
 20 cm, 8"



MAYO-BLAKE EV63111-20  
 20 cm, 8"



MIXTER EV63117-22  
 22 cm, 8 3/4"

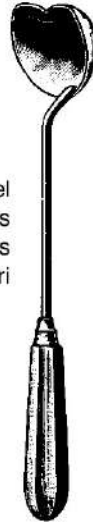
Gallensteinsonden, Gallengangdilatoren  
 Gall Stone Probes, Bile duct dilators

Exploradores para cálculos biliares, Dilatadores para conductos biliares  
 Sonde per calcoli biliari, Dilatatori per condotti biliari

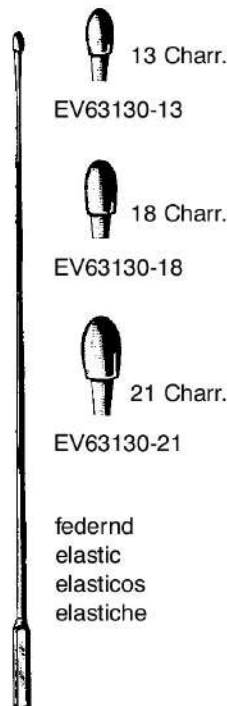
GERNAL SURGICAL

Ø 5,8 cm

Gallensteinlöffel  
 Gall Stone Scoops  
 Cucharillas para cálculos biliares  
 Cucchiari per calcoli biliari



MOOR  
 EV63125-28  
 28 cm, 11"



13 Charr.

EV63130-13

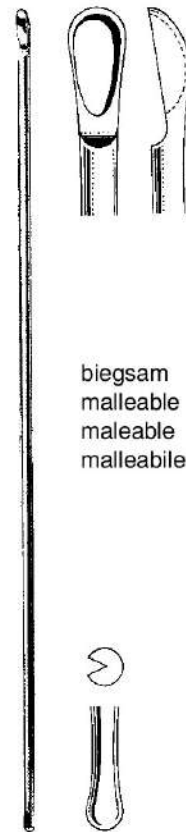
18 Charr.

EV63130-18

21 Charr.

EV63130-21

federnd  
 elastic  
 elasticos  
 elastiche

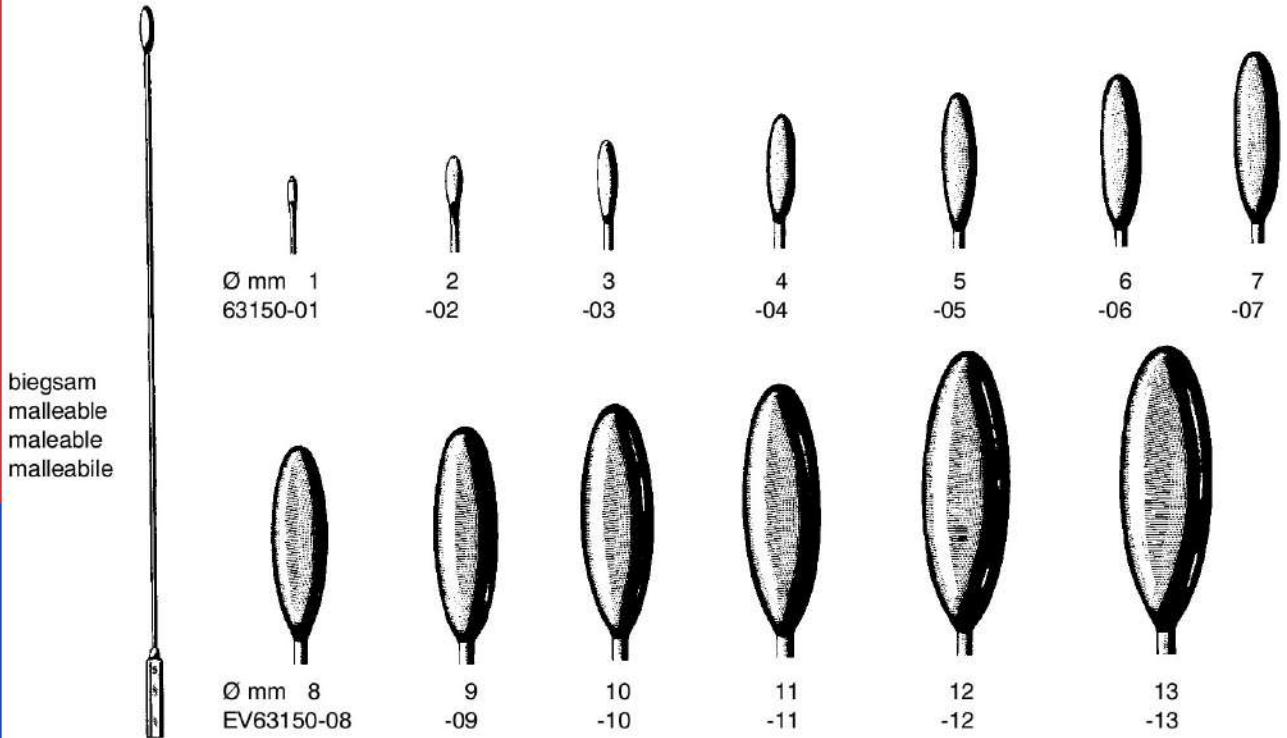


biegsam  
 malleable  
 maleable  
 malleabile

DESJARDINS EV63130-13  
 - EV63130-21 28 cm, 11"

MOYNIHAN EV63142-34  
 34 cm, 13 1/2"

Gallensteinsonden, Gallengangdilatoren  
 Gall Stone Probes, Bile duct dilators  
 Exploradores para cálculos biliares, Dilatadores para conductos biliares  
 Sonde per calcoli biliari, Dilatatori per condotti biliari



BAKES EV63150-01 -  
 EV63150-13 30 cm, 11  
<sup>3/4"</sup>

EV63150-00 = Satz à 9 St. / set of 9 size 3 to 11  
 juego de 9 fig. 3-11 / serie di 9 pezzi

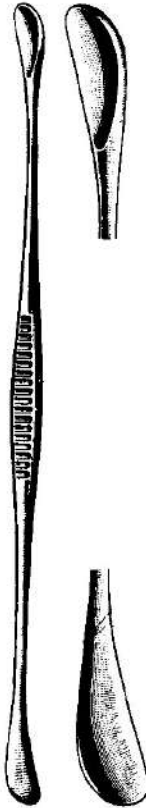
Gallensteinlöffel  
Gall Stone Scoops  
Cucharillas para cálculos biliares  
Cucchiai per calcoli biliari

GERNAL SURGICAL

biegsam  
malleable  
maleables  
malleabile



LUER-KOERTE  
EV63173-01 - EV63173-08  
32 cm, 12 3/4"



FERGUSSON EV63170-21 -  
EV63170-23

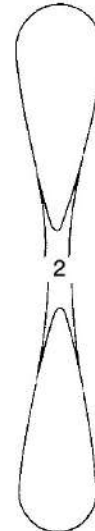
8,5 mm

11,5 mm

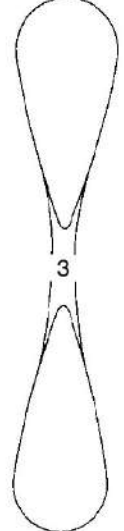
12,5 mm



1



2



3

10,5 mm

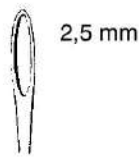
12,5 mm

13,0 mm

EV63170-21  
24 cm  
9 1/2"

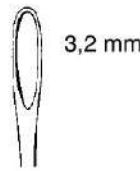
EV63170-22  
24 cm  
9 1/2"

EV63170-23  
24 cm  
9 1/2"



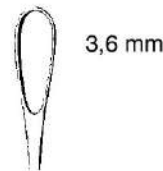
2,5 mm

Fig. 000  
EV63173-01



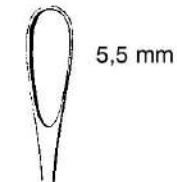
3,2 mm

Fig. 00  
EV63173-02



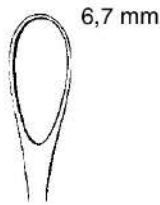
3,6 mm

Fig. 0  
EV63173-03



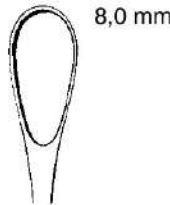
5,5 mm

Fig. 1  
EV63173-04



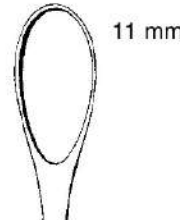
6,7 mm

Fig.2  
EV63173-05



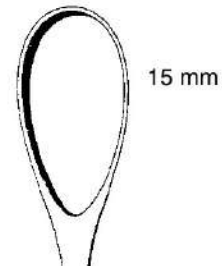
8,0 mm

Fig. 3  
EV63173-06



11 mm

Fig. 4  
EV63173-07



15 mm

Fig. 5  
EV63173-08

Gallensteinlöffel, Gallengangsonde  
 Gall Stone Scoops, Gall Duct Probes  
 Cucharillas para cálculos biliares, sonda para conducto biliar  
 Cucchiari per calcoli biliari, sonda per bile



MAYO  
 EV63175-27  
 27 cm, 10 1/2"



EV63178-01  
 klein, small, pequeña, piccola

EV63178-03  
 groß, large, grande

MAYO EV63178-01 -  
 EV63178-03 27 cm, 10 1/2"



federnd  
 elastic  
 elásticas  
 elastiche

DESJARDINS EV63180-17  
 - EV63180-27 30 cm, 11 3/4"



17 Charr.

Fig. 1  
 EV63180-17



21 Charr.

Fig. 2  
 EV63180-21



24 Charr.

Fig. 3  
 EV63180-24



27 Charr.

Fig. 4  
 EV63180-27



biegsam  
 malleable  
 maleable  
 malleabile

MAYO  
 EV63210-32  
 32 cm, 12 3/4"

Nierensteinzange  
Kidney Stone Forceps  
Pinzas para cálculos renales,  
Pinze per calcoli renali

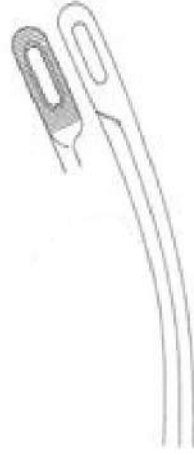


Fig. 1  
EV63231-01 23 cm, 9"

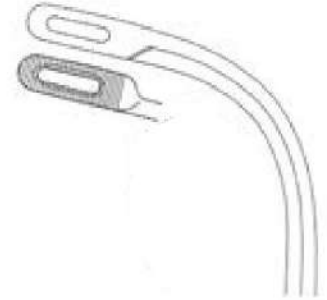


Fig. 2  
EV63231-02 22 cm, 8 3/4"

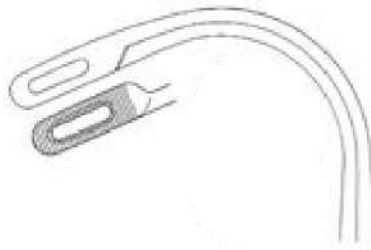


Fig. 3  
EV63231-03 22 cm, 8 3/4"



Fig. 4  
EV63231-04 22 cm, 8 3/4"



RANDALL

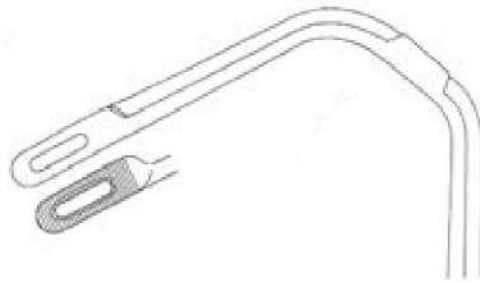


Fig. 5  
EV63231-05 19 cm, 7 1/2"



Fig. 6  
EV63231-06 19 cm, 7 1/2"

Nierensteinzange  
Kidney Stone Forceps  
Pinzas para cálculos renales  
Pinze per calcoli renali



HEIMING

für Kinder  
for children  
para niños  
per bambini

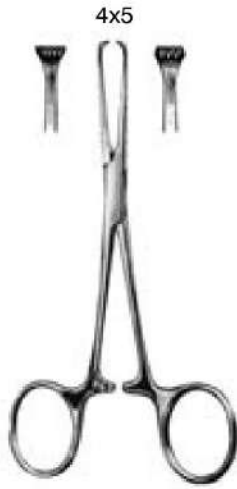


EV63232-01  
17 cm, 6 <sup>3</sup>/<sub>4</sub>"

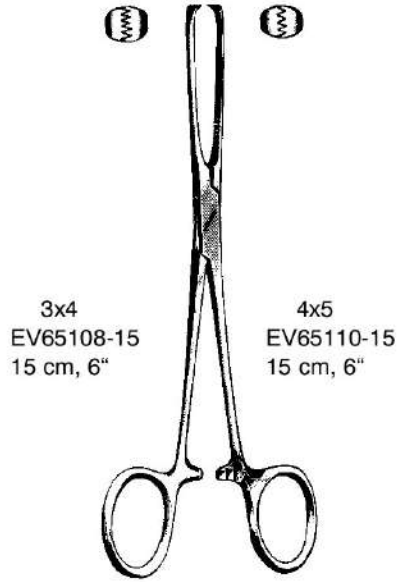


EV63232-02  
16 cm, 6 <sup>1</sup>/<sub>4</sub>"

Darm- und Gewebefasszangen  
 Intestinal and Tissue Grasping Forceps  
 Pinzas para intestinos y tejidos  
 Pinze per afferrare intestino e tessuti

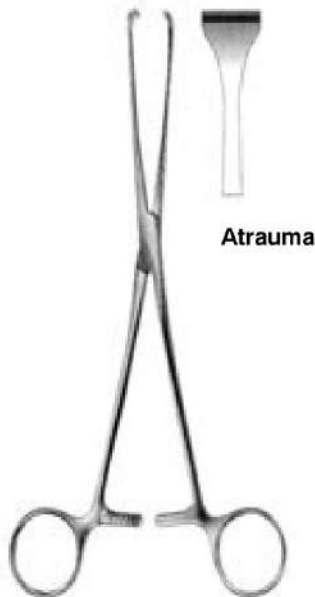


ALLIS-BABY EV65102-12  
 12 cm, 4 3/4"  
 EV65102-14 14 cm, 5 1/2"

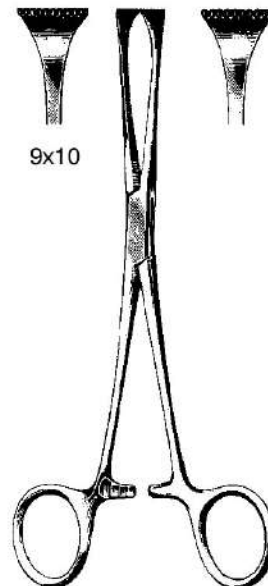


3x4 EV65108-15 15 cm, 6"  
 4x5 EV65110-15 15 cm, 6"

ALLIS 5x6  
 EV65120-15 15 cm, 6"  
 EV65120-19 19 cm, 7 1/2"  
 EV65120-22 22 cm, 8 3/4"  
 EV65120-24 24 cm, 9 1/2"



ALLIS  
 EV65124-16 16 cm, 6 1/4"  
 EV65124-20 20 cm, 8"  
 EV65124-22 22 cm, 8 3/4"  
 EV65124-25 25 cm, 10"  
 EV65124-30 30 cm, 11 3/4"



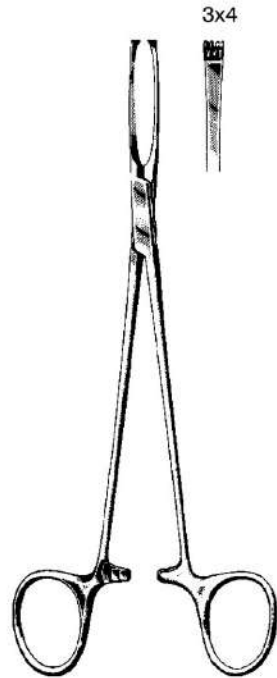
ALLIS-ADAIR  
 EV65130-15  
 15,5 cm, 6"



Darm- und Gewebefasszangen  
 Intestinal and Tissue Grasping Forceps  
 Pinzas para intestinos y tejidos  
 Pinze per afferrare intestino e tessuti



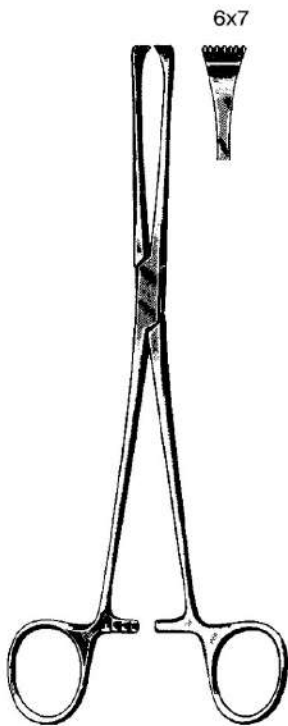
**LOCKWOOD-ALLIS**  
 EV65132-16 16 cm, 6 1/4"  
 EV65132-20 20 cm, 8"



**JUDD-ALLIS**  
 EV65140-15 15 cm, 6"  
 EV65140-19 19 cm, 7 1/2"



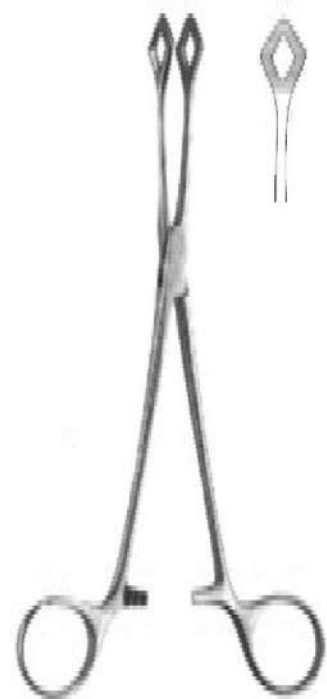
**BOYS-ALLIS**  
 EV65145-15 15 cm, 6"



**THOMS-ALLIS**  
 EV65150-20 20 cm, 8"

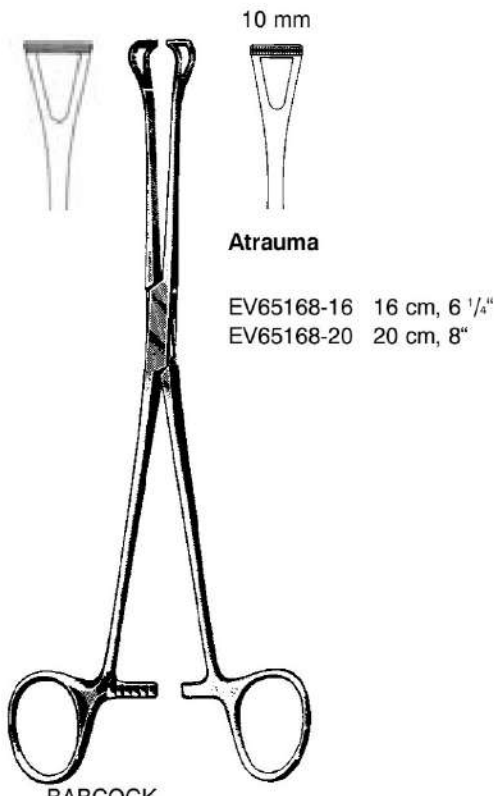


**LITTLEWOOD**  
 EV65154-18 18,5 cm, 7 1/4"

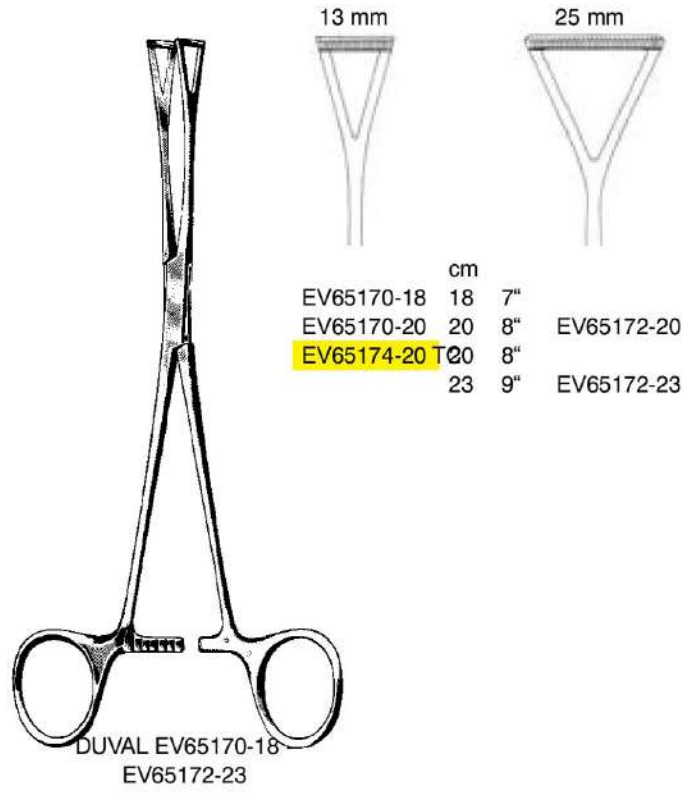


**GREGOIRE**  
 EV65155-18 18 cm, 7"  
 EV65155-20 20 cm, 8"

Darm- und Gewebefasszangen  
 Intestinal and Tissue Grasping Forceps  
 Pinzas para intestinos y tejidos  
 Pinze per afferrare intestino e tessuti

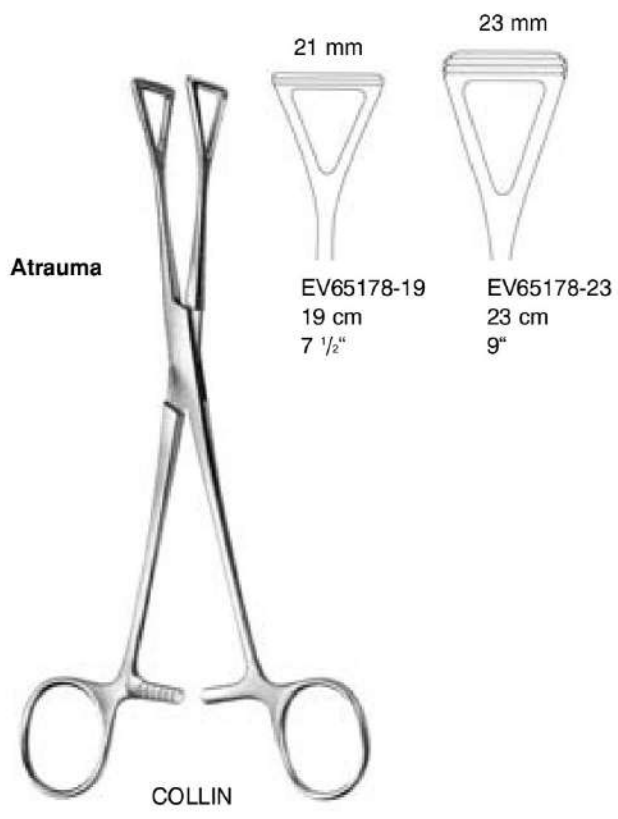


**Atrauma**  
 EV65168-16 16 cm, 6 1/4"  
 EV65168-20 20 cm, 8"



|            |    |            |
|------------|----|------------|
|            | cm |            |
| EV65170-18 | 18 | 7"         |
| EV65170-20 | 20 | 8"         |
| EV65174-20 | 20 | 8"         |
|            | 23 | 9"         |
|            |    | EV65172-20 |
|            |    | EV65172-23 |

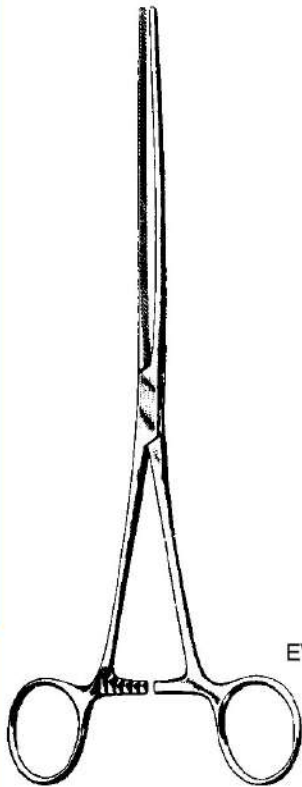
**BABCOCK**  
 EV65160-14 14 cm, 5 1/2"  
 EV65160-16 16 cm, 6 1/4" **EV65164-16 TC 16 cm**  
 EV65160-18 18 cm, 7"  
 EV65160-20 20 cm, 8" **EV65164-20 TC 20 cm**  
 EV65160-24 24 cm, 9 1/2"



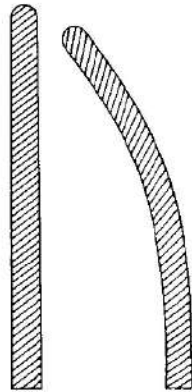
**Atrauma**  
 EV65178-19 19 cm 7 1/2"  
 EV65178-23 23 cm 9"



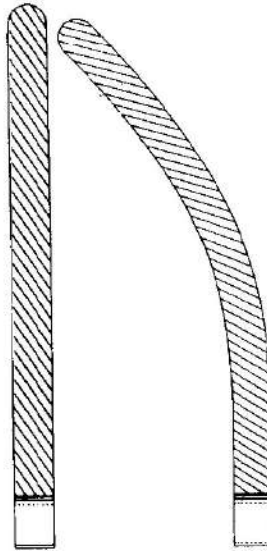
**WILLIAMS**  
 EV65180-16 16,5 cm, 6 1/2"



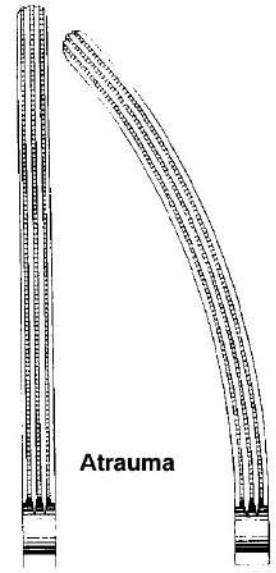
DOYEN EV65210-18  
- EV65217-23



DOYEN-BABY  
EV65210-18  
EV65211-18 18 cm, 7"

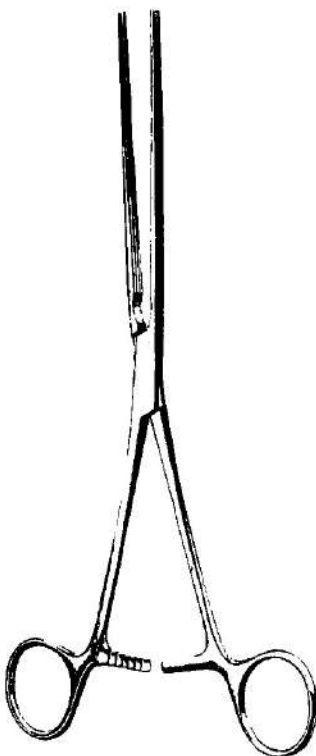


DOYEN  
EV65210-21 21 cm, 8 1/4"  
EV65211-21  
EV65210-23 23 cm, 9"  
EV65211-23

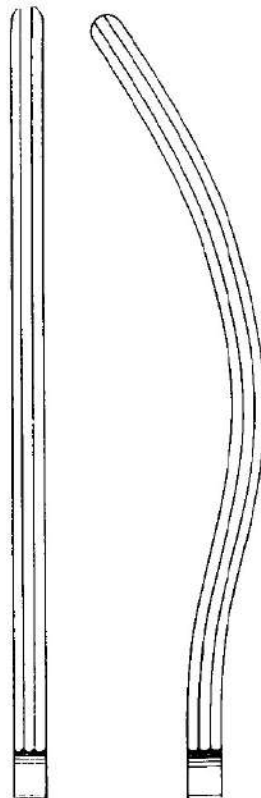


Atrauma

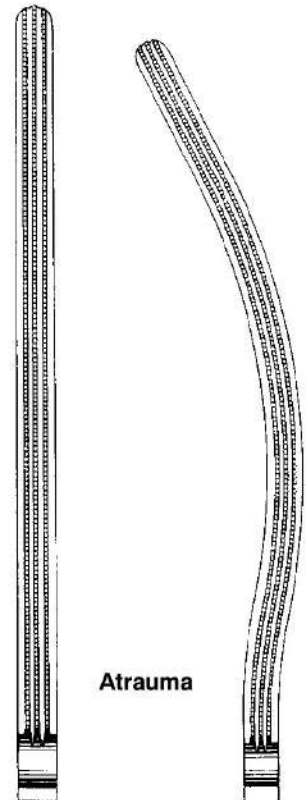
DOYEN  
EV65216-13 13 cm, 5 1/8" EV65217-13  
EV65216-16 16 cm, 6 1/4" EV65217-16  
EV65216-18 18 cm, 7" EV65217-18  
EV65216-21 21 cm, 8 1/4" EV65217-21  
EV65216-23 23 cm, 9" EV65217-23



KOCHER EV65220-22 -  
EV65227-28



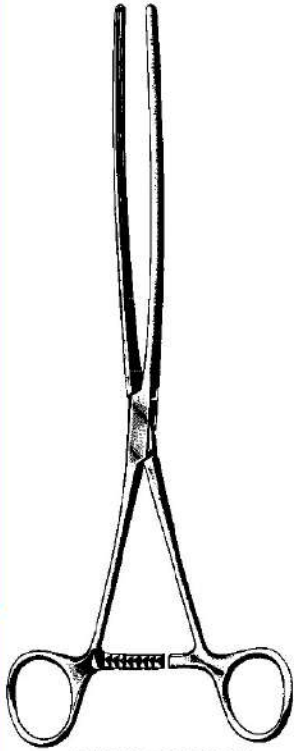
EV65220-13 13 cm, 5 1/8" EV65221-13  
EV65220-22 22 cm, 8 3/4" EV65221-22  
EV65220-25 25 cm, 10" EV65221-25  
EV65220-28 28 cm, 11" EV65221-28



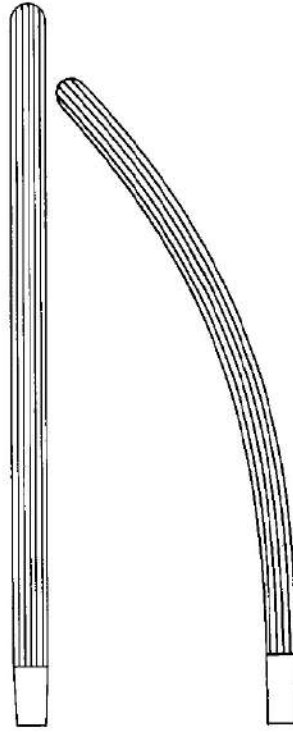
Atrauma

BABY-KOCHER  
EV65226-22 22 cm, 8 3/4" EV65227-22  
EV65226-25 25 cm, 10" EV65227-25  
EV65226-28 28 cm, 11" EV65227-28

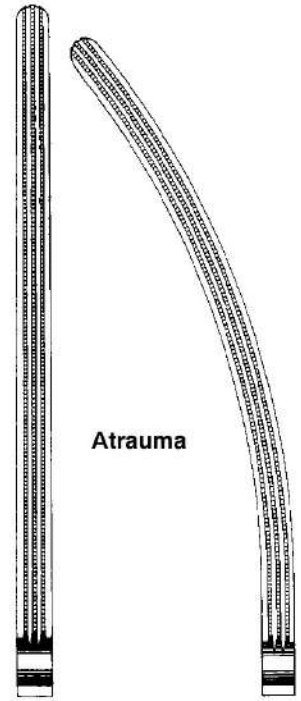
Darmklemmen  
Intestinal Forceps  
Pinzas intestinales  
Pinze intestinali



**MAYO-ROBSON**  
EV65230-21 21 cm, 8 1/4"  
EV65237-25 25 cm, 10"



EV65230-21 21 cm, 8 1/4" EV65231-21  
EV65230-23 23 cm, 9" EV65231-23  
EV65230-25 25 cm, 10" EV65231-25



**Atrauma**  
EV65236-25 25 cm, 10" EV65237-25



**SCUDDER**  
EV65238-33  
33 cm, 13"



**Atrauma**



EV65239-33  
33 cm, 13"

Darmklemmen  
Intestinal Forceps  
Pinzas intestinales  
Pinze intestinali



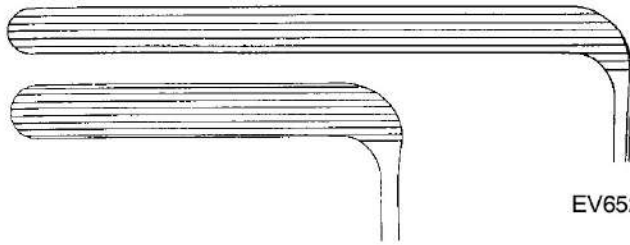
FEHLAND  
EV65241-23  
23,5 cm 9 1/4"



Atrauma

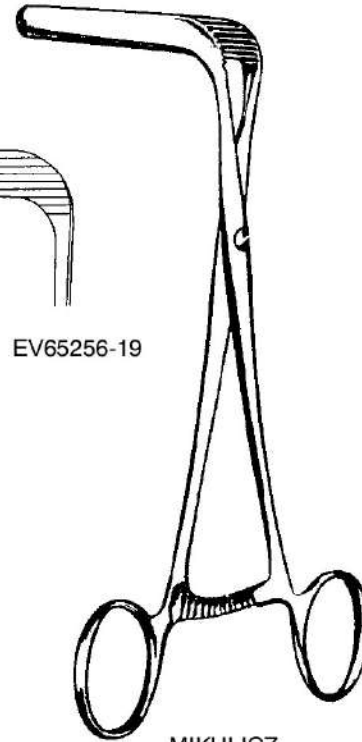
RESANO  
EV65242-30  
30 cm, 11 3/4"

Magen-Darmklemmen  
Intestinal and Stomach Clamps  
Pinzas-clamps intestinales y estomacales  
Pinze intestinali e stomacali



EV65255-19

EV65256-19



MIKULICZ  
19 cm, 7 1/2"



BRUNNER  
24 cm, 9 1/2"

Atrauma



EV65259-24



EV65260-24

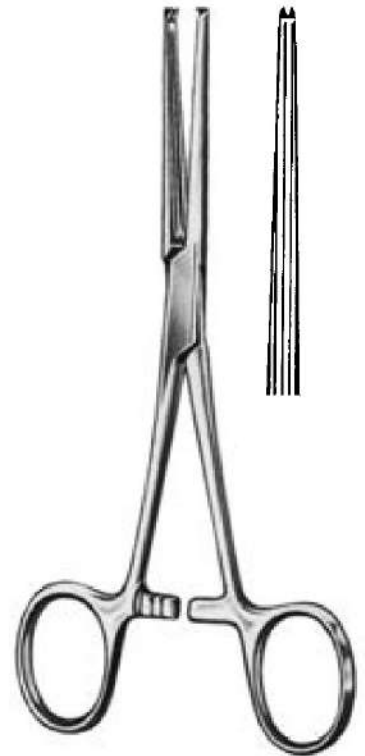
Pyloruspreizer, Blinddarmklemmen  
 Pylorus spreader, Blindgut forceps  
 Separador para píloro, Pinzas para apéndice  
 Divaricatori per piloro, Pinza per appendice



**BENSON**  
 EV65261-15  
 15,5 cm, 6"

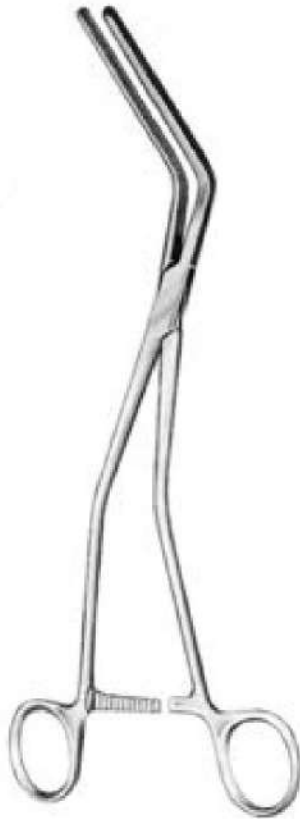


**KLEINSCHMIDT**  
 EV65262-12  
 12 cm, 4 3/4"

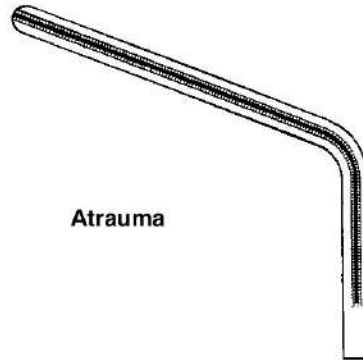


**ALLEN**  
 EV65263-15 15 cm, 6"  
 EV65263-20 20 cm, 8"

Darm-Anastomosenklemmen  
 Intestinal Anastomosis Clamps  
 Clamps para anastomosis intestinales  
 Pinze per anastomosi intestinali

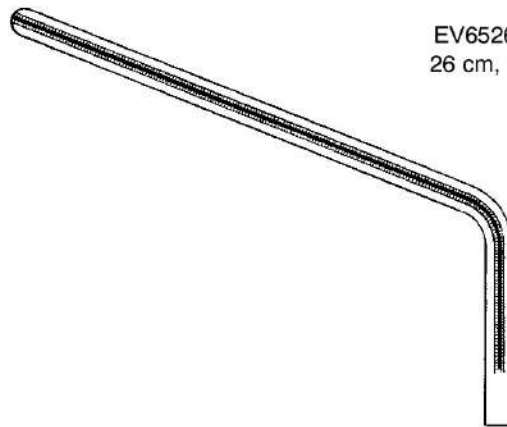


HAYES  
 EV65265-26 26 cm, 10 1/4"  
 EV65265-28 28 cm, 11"

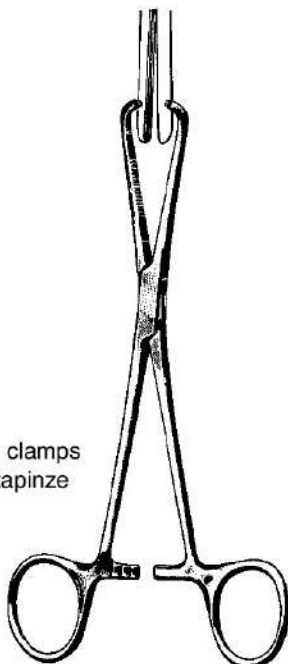


Atrauma

EV65265-26  
 26 cm, 10 1/4"



EV65265-28  
 28 cm, 11"



Schließklemme  
 Closing Forceps  
 Pinza para cerrar clamps  
 Serrapinze e portapinze

STONE-WATT  
 EV65270-15  
 15,5 cm, 6"



STONE-WATT  
 EV65272-07 7,5 cm, 3"  
 EV65272-10 10,0 cm, 4"

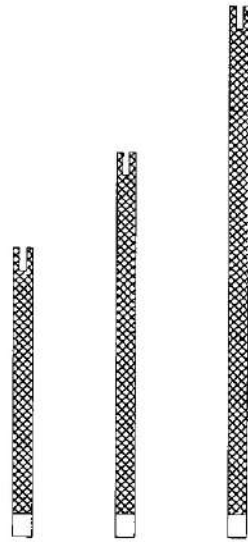
Klemmschloß  
 Locking Device  
 Cierre para clamps intestinales  
 Serratura per pinze intestinali



STONE-WATT  
 EV65274-00



Darm-Anastomosenklemmen  
 Intestinal Anastomosis Clamps  
 Clamps para anastomosis intestinales  
 Pinze per anastomosi intestinali

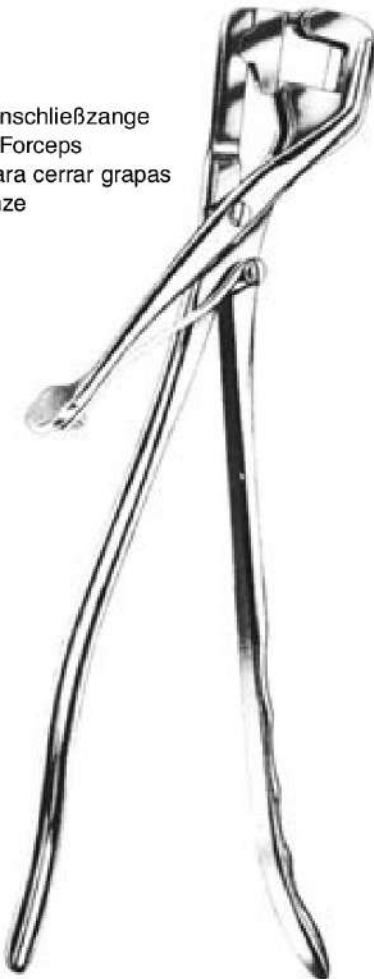


50 mm    70 mm    100 mm

DE MARTEL-WOLFSON

- EV65280-05 5 cm, 2" set of 3
- EV65280-07 7 cm, 2 3/4" set of 3
- EV65280-10 10 cm, 4" set of 3

Klemmschließzange  
 Closing Forceps  
 Pinza para cerrar grapas  
 Serrapinze



DE MARTEL-WOLFSON  
 EV65282-26 26 cm, 10 1/4"



Klemmenhalterung  
 Clamp Holder  
 Porta-clamp  
 Portapinze

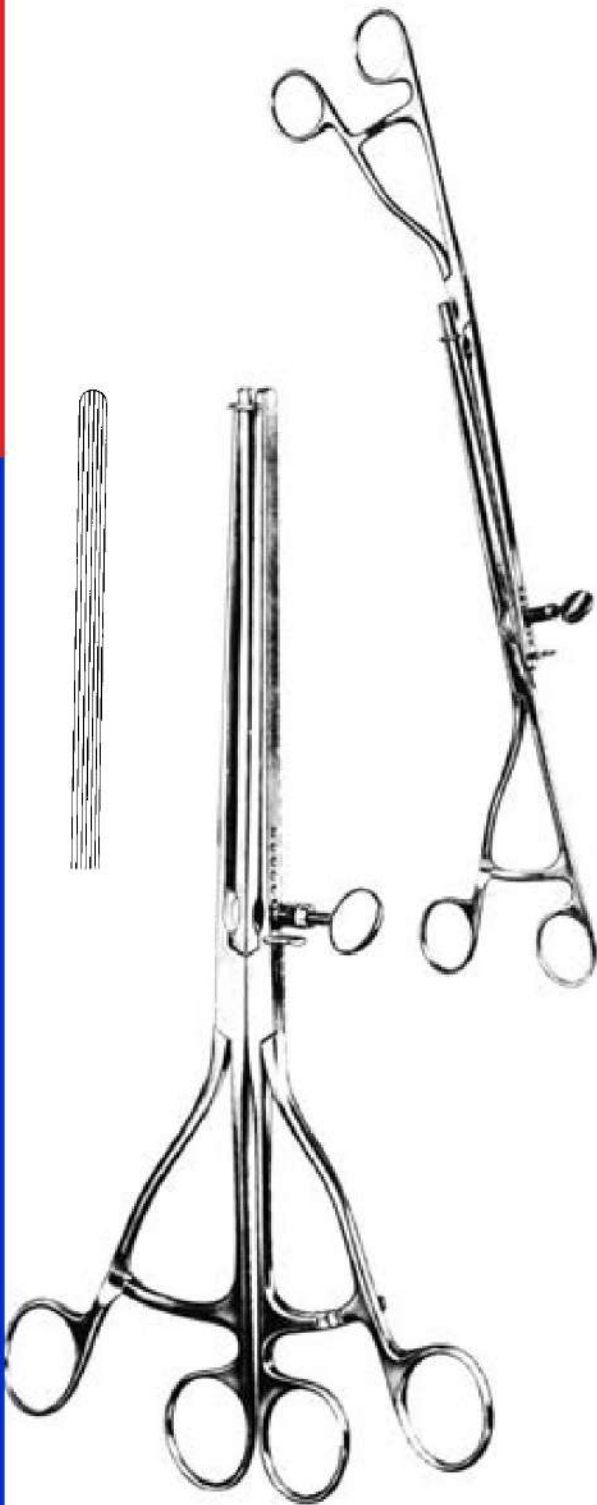


DE MARTEL-WOLFSON  
 EV65284-08 8,5 cm, 3 1/2"

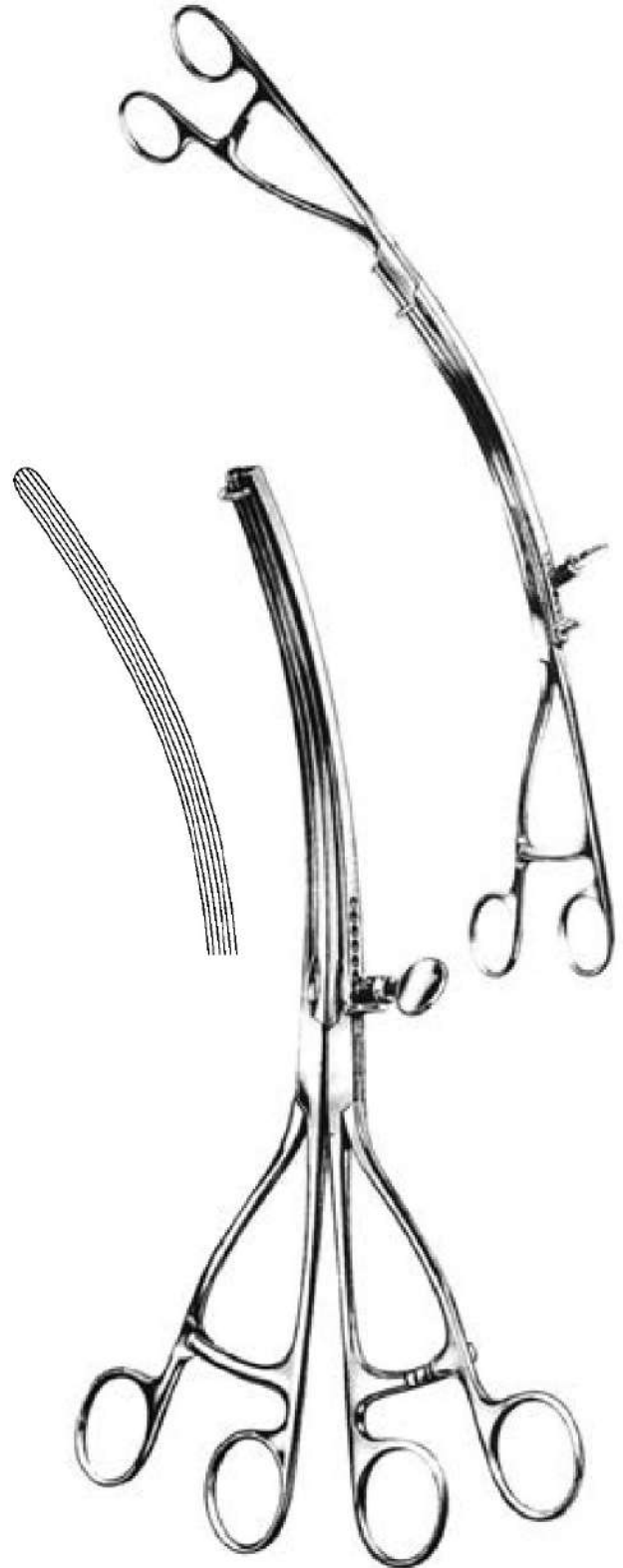
DE MARTEL-WOLFSON  
 EV65284-23 23 cm, 9"

Magen- und Darm-Zwillingsklemmen  
Stomach and Intestinal Anastomosis Twin Clamps  
Pinzas gastro-intestinales gemales  
Pinze gastrointestinali gemelle

GERNAL SURGICAL

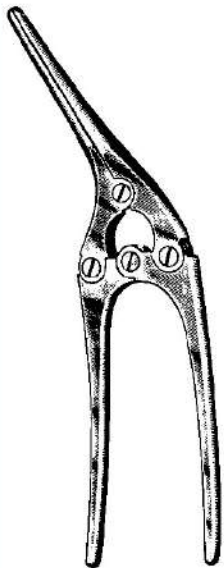


LANE EV65290-30  
30 cm, 11 3/4"



LANE EV65291-30  
30 cm, 11 3/4"

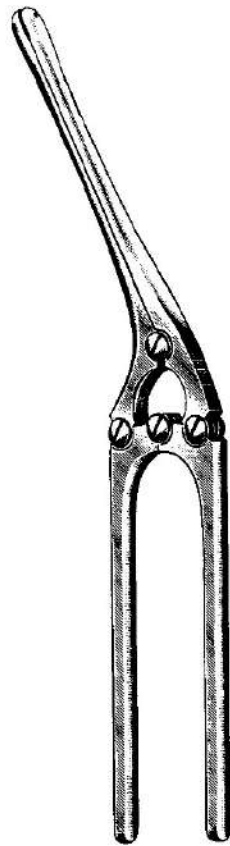
Darm- und Magenquetschklemmen  
Intestinal and Stomach Clamps  
Pinzas-clamps intestinales y estomacales  
Pinze e Schiacciatori per l'intestino e lo stomaco



PAYR-BABY  
EV65310-15  
15 cm, 6"



EV65310-21  
21 cm, 8 1/4"



PAYR



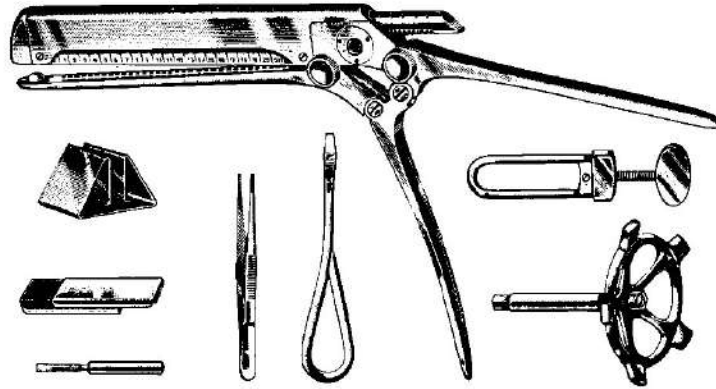
EV65310-29  
29 cm, 11 1/2"



EV65310-35  
35 cm, 14"



Magen- und Darmnähapparat  
 Stomach and Intestinal Suturing Apparatus  
 Aparato para suturar estómago e intestinos  
 Apparecchiature di sutura gastro-intestinale



V. PETZ  
 EV65320-00 komplett  
 in Holzetui compl. in  
 wooden case en  
 estuche de madera in  
 astuccio di legno

bestehend aus:

- Nähapparat
- Holzetui
- Zusatzschloß
- Kurbel
- Füllständer
- Füllstift
- Füllpinzette
- Schraubenzieher
- Etui für Klammern
- Silberklammern  
(Pack à 300 Stck.)

consisting of:

- suturing apparatus
- wooden case
- additional closing clamp
- gear wheel
- filling rack
- filling pin
- filling tweezers
- screw driver
- metal box for clips
- silver suturing clips  
(Pack of 300 ea.)

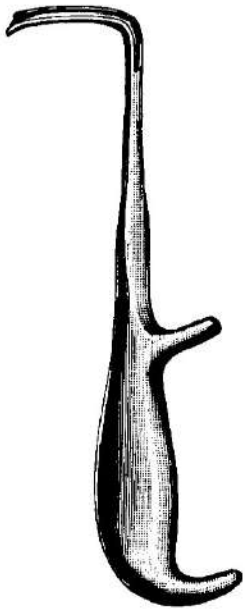
compuesto de:

- Aparator para suturar
- Estuche de madera
- Cierre adicional
- Manivela
- Soporte para rellenar
- Espiga para rellenar
- Pinza para rellenar
- Destornillador
- Estuche para agrafas
- Agrafas para sutura de plata  
(Paquete de 300 pzas.)

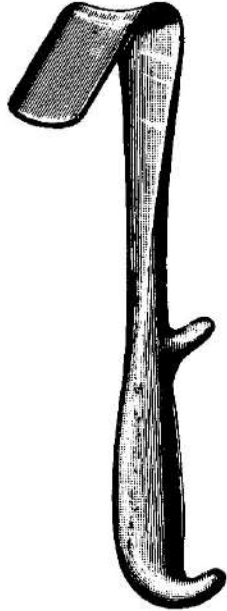
composta da:

- apparecchio per la sutura
- astuccio in legno
- Serratura supplementare
- manovella
- supporto di riempimento agraiffe
- perno per posizionare le agraiffe
- pinza per caricare
- cacciavite
- scatola in metallo per agraiffe
- agraiffe in argento  
(confezione da 300 pezz.)

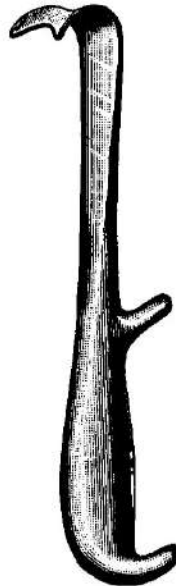
Prostatahaken, Prostatafaßzange, Kapsel­faßzange  
 Prostatic retractors, Grasping forceps for the capsule – anterior lobe and ligature carrier  
 Separador para prostata, pinza de agarre para capsula y prostate  
 Divaricatori per prostata, pinza per afferrare la capsula e prostata



YOUNG  
 EV67101-21  
 21 cm, 8 1/4"



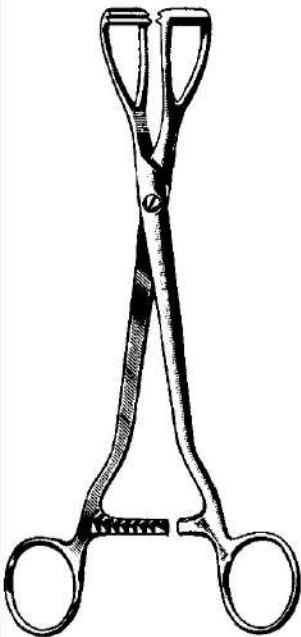
YOUNG  
 EV67103-22  
 22 cm, 8 3/4"



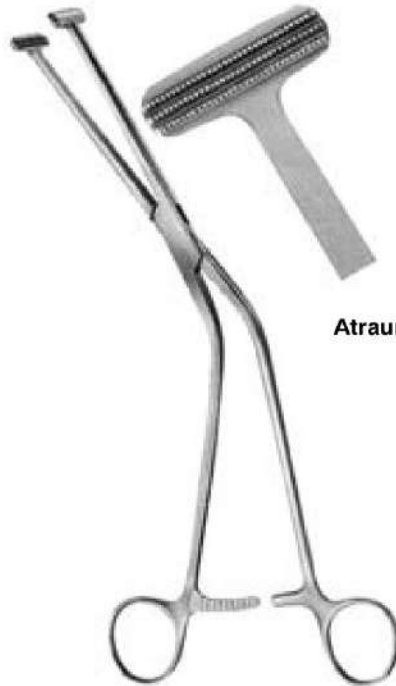
YOUNG  
 EV67105-21  
 21 cm, 8 1/4"



YOUNG  
 EV67105-22  
 22 cm, 8 3/4"

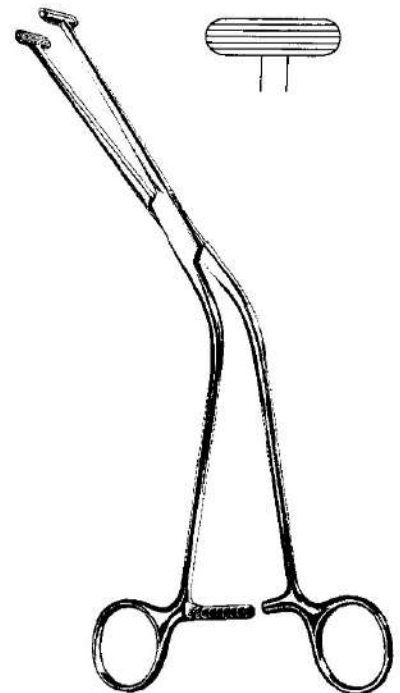


YOUNG  
 EV67106-20  
 20 cm, 8"



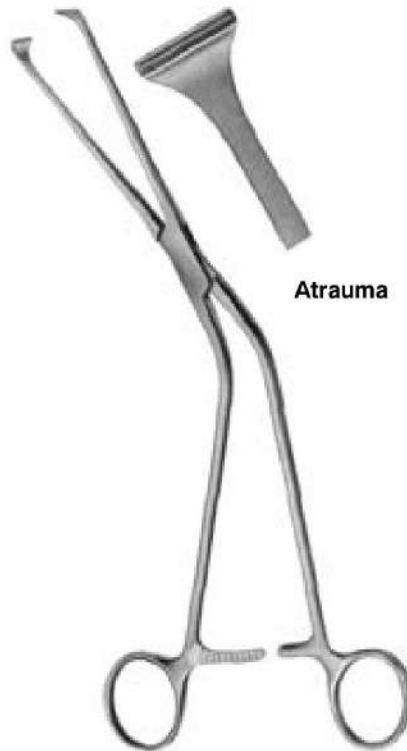
Atrauma

MILLIN  
 EV67110-23  
 23,5 cm, 9 1/4"

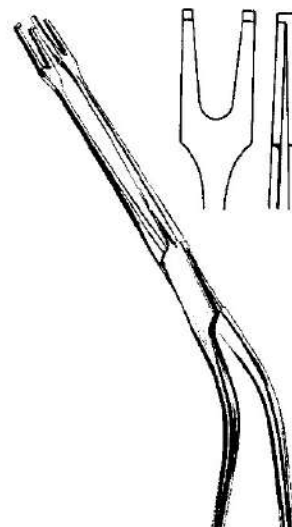
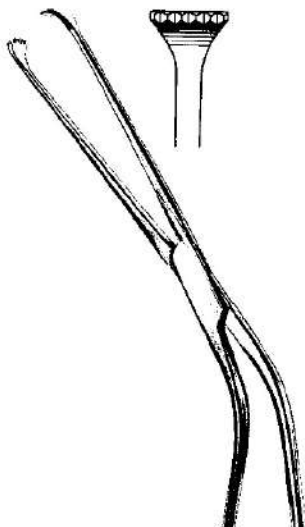


MILLIN  
 EV67111-23  
 23 cm, 9"

Kapselasszange, Fadenföhrungsazange  
Capsule Forceps, Ligature Carrying Forceps  
Pinzas capsulares, Pinza porta ligaduras  
Pinze per afferrare capsule, Pinza porta-filo



MILLIN  
EV67122-23  
24,5 cm, 9 3/4"



Blasenwundspreizer, Blasenspatel  
 Bladder Retractors  
 Separadores vesicales, Espátula vesical  
 Divaricatori vescicali, Spatoli vescicali

EV67130-01

- 2 Valven, 2 blades, 2 valvas, 2 valve 57 mm x 25 mm 67130-02
- 2 Valven, 2 blades, 2 valvas, 2 valve 80 mm x 25 mm 67130-03
- 1 Valven, 1 blade, 1 valva, 1 valve 120 mm x 45 mm



MILLIN  
EV67130-00

- EV67130-00 ohne Kaltlicht
- EV67132-00 Kaltlichtaufsatz für EV67130-00
- EV67130-0 without fiber optic
- EV67132-0 fiber optic light carrier for EV67130-00
- EV67130-0 sin soporte de luz fría
- EV67132-0 soporte de luz fría para EV67130-00
- EV67130-00 senza fibre ottiche
- EV67132-00 supporto per luce fredda per EV67130-00



LEGUEU  
EV67147-27

KOCHER  
EV67149-27



JUDD-MASSON

EV67150-0 mit Mittelvalve, with Central Blade con valva central, con valva centrale

EV67155-00

ohne Mittelvalve, without Central Blade sin valva central, senza valva centr.



THOMSON-WALKER  
EV67160-00

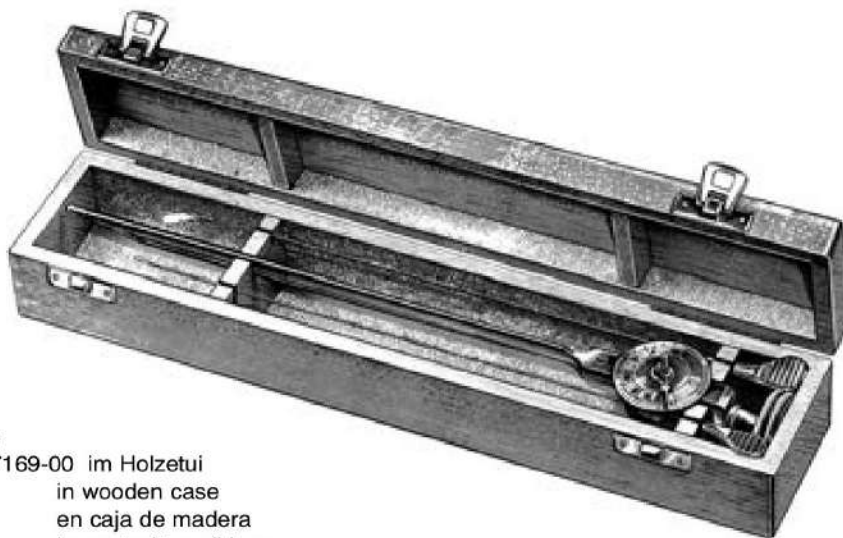
Blasenwundspreizer, Blasenhalssperrer, Urethrotome  
Bladder Retractors, Bladder Neck Spreader, Urethrotomes  
Separadores vesicales, Uretrótomos  
Divaricatori vescicali, Divaricatore del collo vescicale, Uretrotomi



LEGUEU  
EV67163-00



MILLIN  
EV67165-00



OTIS  
EV67169-00 im Holzetui  
in wooden case  
en caja de madera  
in contenitore di legno

EV67169-01  
Ersatzblatt alleine Blade only  
Hoja de repuesto Lame di ri-  
cambio



Fremdkörperzange, Penisklemmen  
Foreign Body Forceps, Penis Seizing Forceps  
Pinzas para cuerpos extraños, Compresores uretrales  
Pinze per corpi estranei, Serrapene



MATHIEU  
EV67172-20 20 cm, 8"  
EV67172-28 28 cm, 11"



STOCKMANN  
EV67175-08  
8 cm, 3 1/8"



STRAUSS  
EV67177-11  
11 cm, 4 3/8"

Vasektomie-Klemme  
Vasectomy Forceps  
Pinza para vasectomia  
Pinza per vasectomia



EV67178-12  
12 cm, 4 3/4"

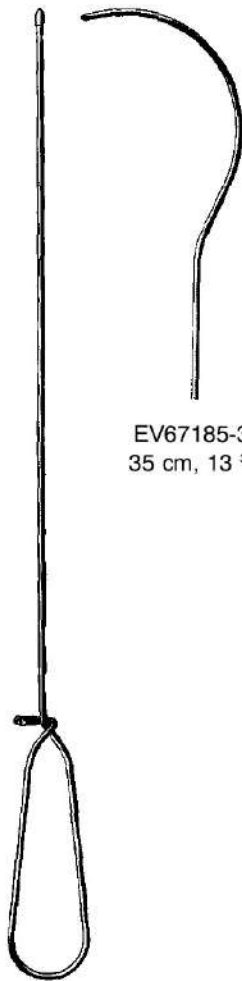


innen Ø 3 mm

EV67178-14  
14 cm, 5 1/2"

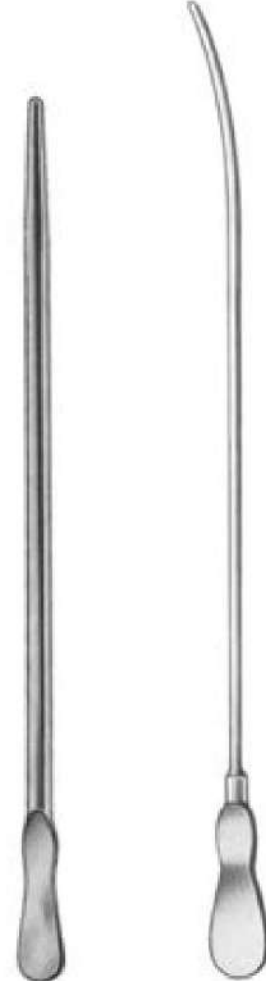
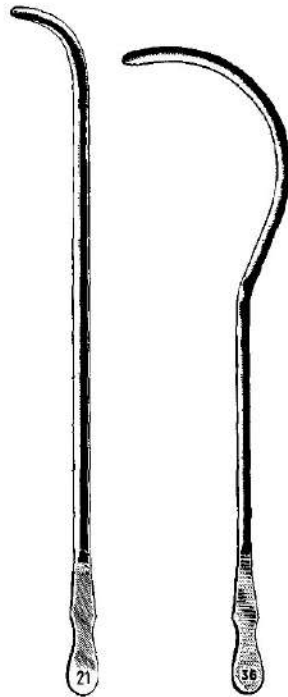


EV67179-14  
14,5 cm, 5 3/4"

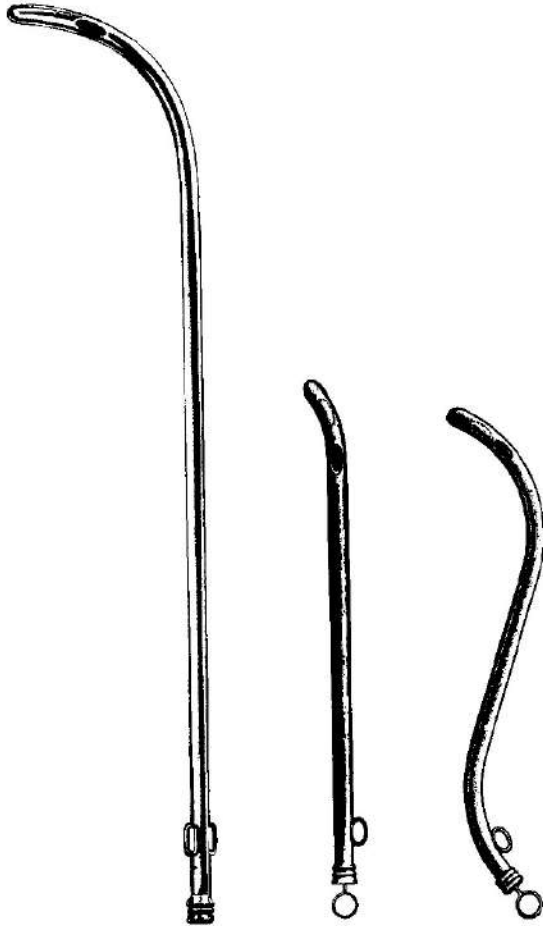


EV67185-35  
 35 cm, 13 3/4"

GUYON  
 EV67184-39  
 39 cm, 15 1/2"



| Charr. | 28 cm (11") | 25 cm (10") | 28 cm (11") | 30 cm (11 3/4") |
|--------|-------------|-------------|-------------|-----------------|
| FG     | VAN BUREN   | GUYON       | DITTEL      | DITTEL          |
| 8      | EV67201-08  | EV67205-08  | EV67206-08  | EV67207-08      |
| 9      |             |             | EV67206-09  | EV67207-09      |
| 10     | EV67201-10  | EV67205-10  | EV67206-10  | EV67207-10      |
| 11     |             |             | EV67206-11  | EV67207-11      |
| 12     | EV67201-12  | EV67205-12  | EV67206-12  | EV67207-12      |
| 13     |             |             | EV67206-13  | EV67207-13      |
| 14     | EV67201-14  | EV67205-14  | EV67206-14  | EV67207-14      |
| 15     |             |             | EV67206-15  | EV67207-15      |
| 16     | EV67201-16  | EV67205-16  | EV67206-16  | EV67207-16      |
| 17     |             |             | EV67206-17  | EV67207-17      |
| 18     | EV67201-18  | EV67205-18  | EV67206-18  | EV67207-18      |
| 19     |             |             | EV67206-19  | EV67207-19      |
| 20     | EV67201-20  | EV67205-20  | EV67206-20  | EV67207-20      |
| 21     |             |             | EV67206-21  | EV67207-21      |
| 22     | EV67201-22  | EV67205-22  | EV67206-22  | EV67207-22      |
| 23     |             |             | EV67206-23  | EV67207-23      |
| 24     | EV67201-24  | EV67205-24  | EV67206-24  | EV67207-24      |
| 25     |             |             | EV67206-25  | EV67207-25      |
| 26     | EV67201-26  | EV67205-26  | EV67206-26  | EV67207-26      |
| 27     |             |             | EV67206-27  | EV67207-27      |
| 28     | EV67201-28  | EV67205-28  | EV67206-28  | EV67207-28      |
| 29     |             |             | EV67206-29  | EV67207-29      |
| 30     | EV67201-30  | EV67205-30  | EV67206-30  | EV67207-30      |
| 32     | EV67201-32  | EV67205-32  |             |                 |
| 34     | EV67201-34  | EV67205-34  |             |                 |
| 36     | EV67201-36  | EV67205-36  |             |                 |
| 38     |             | EV67205-38  |             |                 |
| 40     |             | EV67205-40  |             |                 |



29 cm  
11 1/2"

15 cm  
6"

COXETER



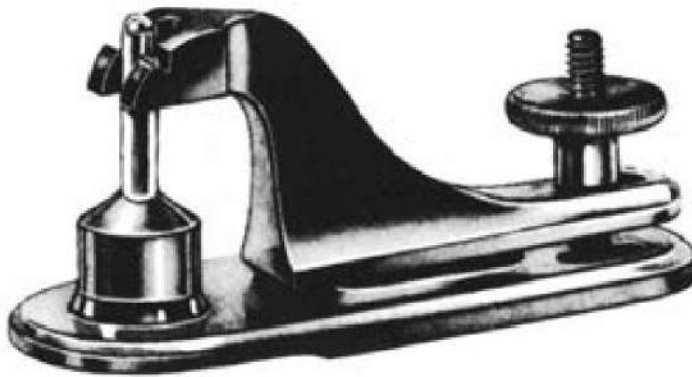
WALTHER  
5 1/4" EV67220-00  
(Set)

Charr.  
FG

|    |            |            |            |
|----|------------|------------|------------|
| 6  | EV67211-06 | EV67213-06 |            |
| 8  | EV67211-08 | EV67213-08 | EV67219-08 |
| 10 | EV67211-10 | EV67213-10 | EV67219-10 |
| 12 | EV67211-12 | EV67213-12 | EV67219-12 |
| 14 | EV67211-14 | EV67213-14 | EV67219-14 |
| 16 | EV67211-16 | EV67213-16 | EV67219-16 |
| 18 | EV67211-18 | EV67213-18 | EV67219-18 |
| 20 | EV67211-20 | EV67213-20 | EV67219-20 |
| 22 | EV67211-22 | EV67213-22 | EV67219-22 |
| 24 | EV67211-24 | EV67213-24 | EV67219-24 |

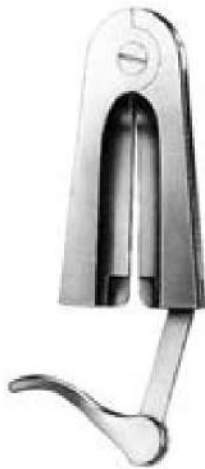
|            |        |
|------------|--------|
| EV67220-12 | 12 Fr. |
| EV67220-14 | 14 Fr. |
| EV67220-16 | 16 Fr. |
| EV67220-18 | 18 Fr. |
| EV67220-20 | 20 Fr. |
| EV67220-22 | 22 Fr. |
| EV67220-24 | 24 Fr. |
| EV67220-26 | 26 Fr. |
| EV67220-28 | 28 Fr. |
| EV67220-30 | 30 Fr. |
| EV67220-32 | 32 Fr. |
| EV67220-34 | 34 Fr. |
| EV67220-36 | 36 Fr. |
| EV67220-38 | 38 Fr. |

Beschneidungsinstrument  
Circumcision Instrument  
Instrumentos para circuncisión  
Strumenti per circoncisione



|            |         |
|------------|---------|
| EV67240-08 | 8 mm Ø  |
| EV67240-11 | 11 mm Ø |
| EV67240-13 | 13 mm Ø |
| EV67240-16 | 16 mm Ø |
| EV67240-21 | 21 mm Ø |
| EV67240-26 | 26 mm Ø |
| EV67240-32 | 32 mm Ø |

EV67240-08 - EV67240-32



**MOGEN**

|            |             |        |
|------------|-------------|--------|
| EV67250-07 | 7,5 cm (3") | 2,5 mm |
| EV67251-07 | 7,5 cm (3") | 1,5 mm |

für Kinder for chil-  
dren para niños  
per bambini

Mastdarm-Spekula  
Rectal Specula  
Espéculos rectales  
Specoli rettali



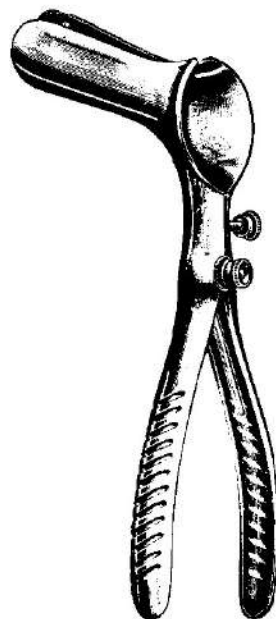
CZERNY  
EV69105-22  
22 cm, 8 3/4"



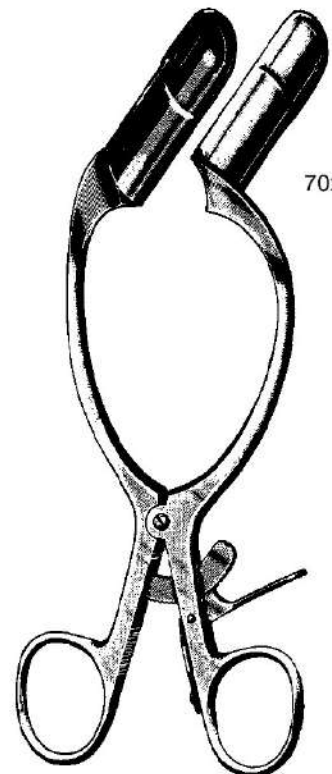
SIMS  
EV69110-15  
15 cm, 6"



BODENHAMMER  
EV69115-15  
15 cm, 6"

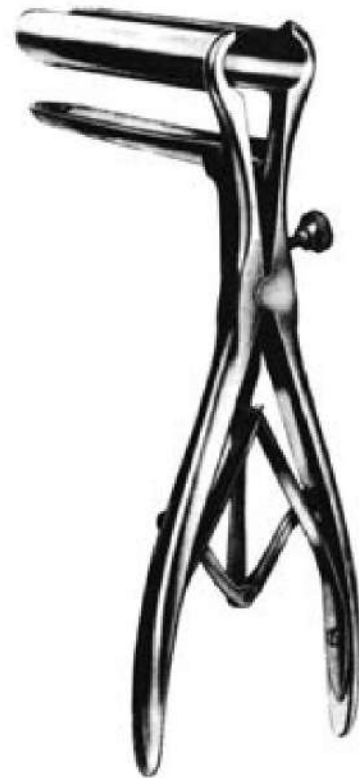
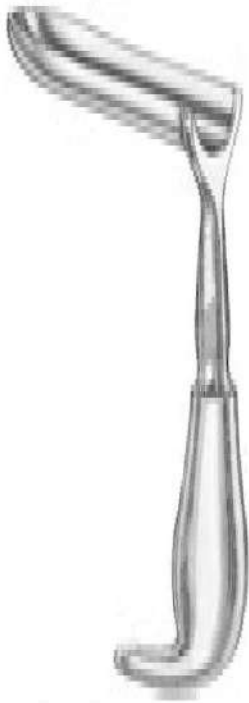


PRATT  
EV69121-00  
19 cm, 7 1/2"



BARR  
EV69125-17  
17 cm, 6 3/4"

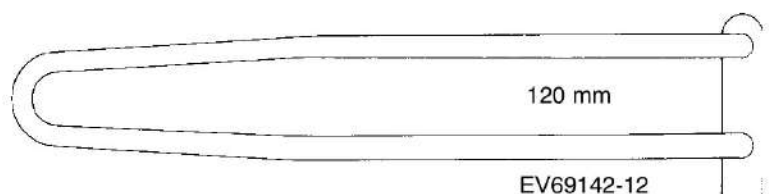
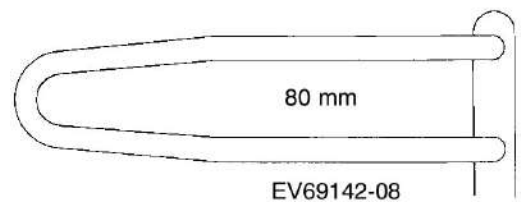
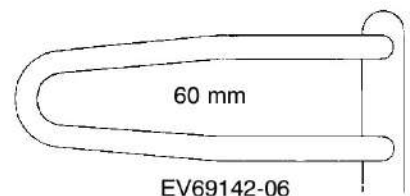
70x22 mm



HILL-FERGUSON, 20 cm, 8"  
V69126-01 6,4x2,2 cm 2 1/2" x 7/8"  
V69126-02 7,6x3,0 cm 3" x 1 3/16"  
V69126-03 7,6x3,6 cm 3" x 1 7/16"

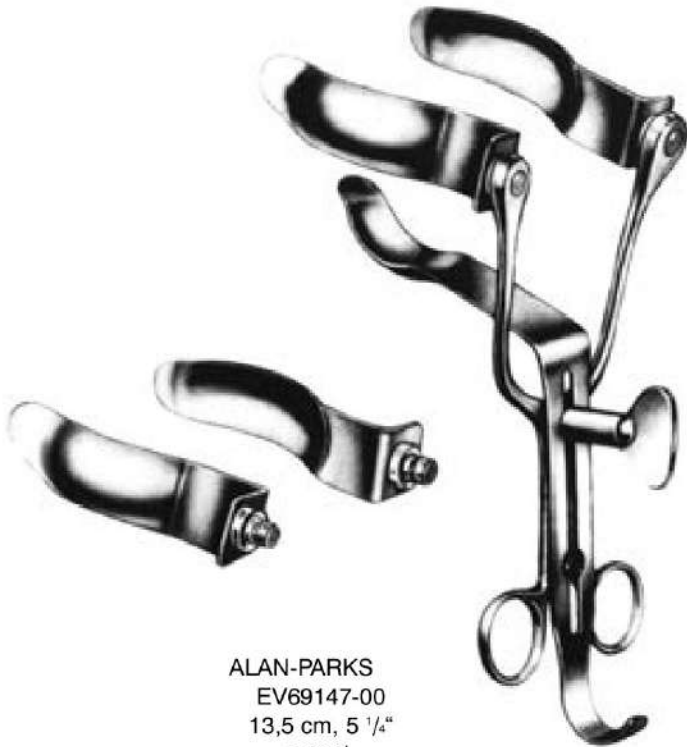
SAWYER, 25 cm, 9 3/4"  
EV69127-01 6,4x2,2 cm 2 1/2" x 7/8"  
EV69127-02 7,6x2,9 cm 3" x 1 1/8"  
EV69127-03 8,9x3,8 cm 3 1/2" x 1 1/2"

MATHIEU  
EV69130-19  
19,5 cm, 7 3/4"



SCHULZE-BERGMANN  
EV69142-06 - EV69142-12

Anal spreizer  
 Anal Retractors  
 Separadores rectales  
 Dilatatori per l'ano e il retto



ALAN-PARKS  
 EV69147-00  
 13,5 cm, 5 1/4"  
 compl.

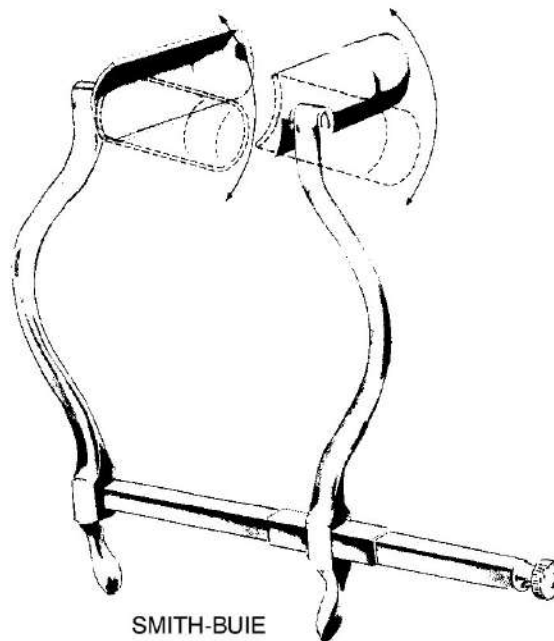
EV69147-01  
 Sperrer allein  
 Spreader only Separador rectal solo Solo  
 telaio senza valve

EV69147-02  
 Mittelblatt allein  
 Center blade, only Valva central, solo  
 Valva centrale, sola

EV69147-03  
 Blatt allein 75 mm, 3"  
 Blade only 75 mm, 3"  
 Valva sola 75 mm, 3" Valva sola 75 mm,  
 3"

EV69147-04  
 Blatt allein 95 mm, 3 3/4"  
 Blade only 95 mm, 3 3/4"  
 Valva sola 95 mm, 3 3/4" Valva sola 95 mm,  
 3 3/4"

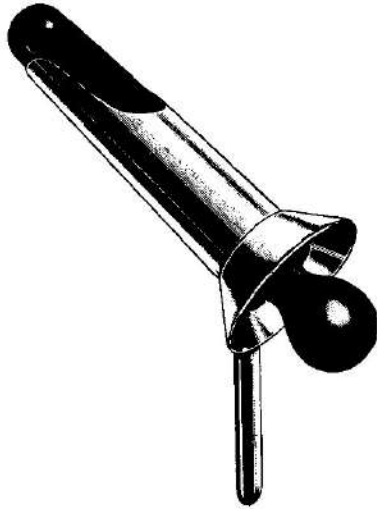
EV69148-00  
 Kaltlicht Zubehör für EV69147-00  
 Cold Light Attachment for EV69147-00  
 Adaptador para luz fría EV69147-00  
 Adattatore luce fredda per EV69147-00



SMITH-BUIE  
 EV69150-15  
 15 cm, 6"  
 75x23 mm



Anuskope, Proktoskope  
Anoscopes, Proctoscopes  
Anoscopios, Proctoscopios  
Anoscopi, Protoscopi



IVES-FANSLER  
EV69210-22 22 mm  
Ø L = 80 mm



|      |            |
|------|------------|
| Ø mm | HIRSCHMANN |
| 16   | EV69212-16 |
| 19   | EV69212-19 |
| 22   | EV69212-22 |
|      | L = 65 mm  |

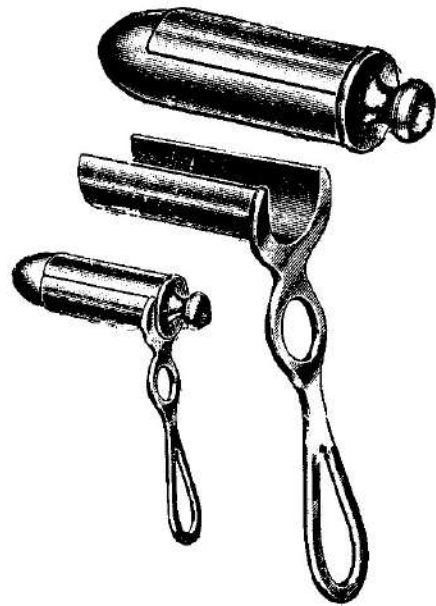


|        |            |
|--------|------------|
| mm     |            |
| ØxL    | KELLY      |
| 22x 50 | EV69220-05 |
| 22x100 | EV69220-10 |
| 22x140 | EV69220-14 |
| 22x200 | EV69220-20 |

Sphinkteroskope, Proktoskope, Fistelsonde  
 Sphincteroscopes, Proctoscopes, Fistula Probe  
 Esfinteroscopios, Proctoscopios, Sondas para fistulas  
 Sfinteroscopi, Protoscopi, Sonde per fistole



Ø mm KELLY  
 21 EV69224-21  
 27 EV69224-27  
 L = 50 mm, 2"



Ø mm CHELSEA-EATON  
 22 x 65 EV69225-22  
 30 x 65 EV69225-30



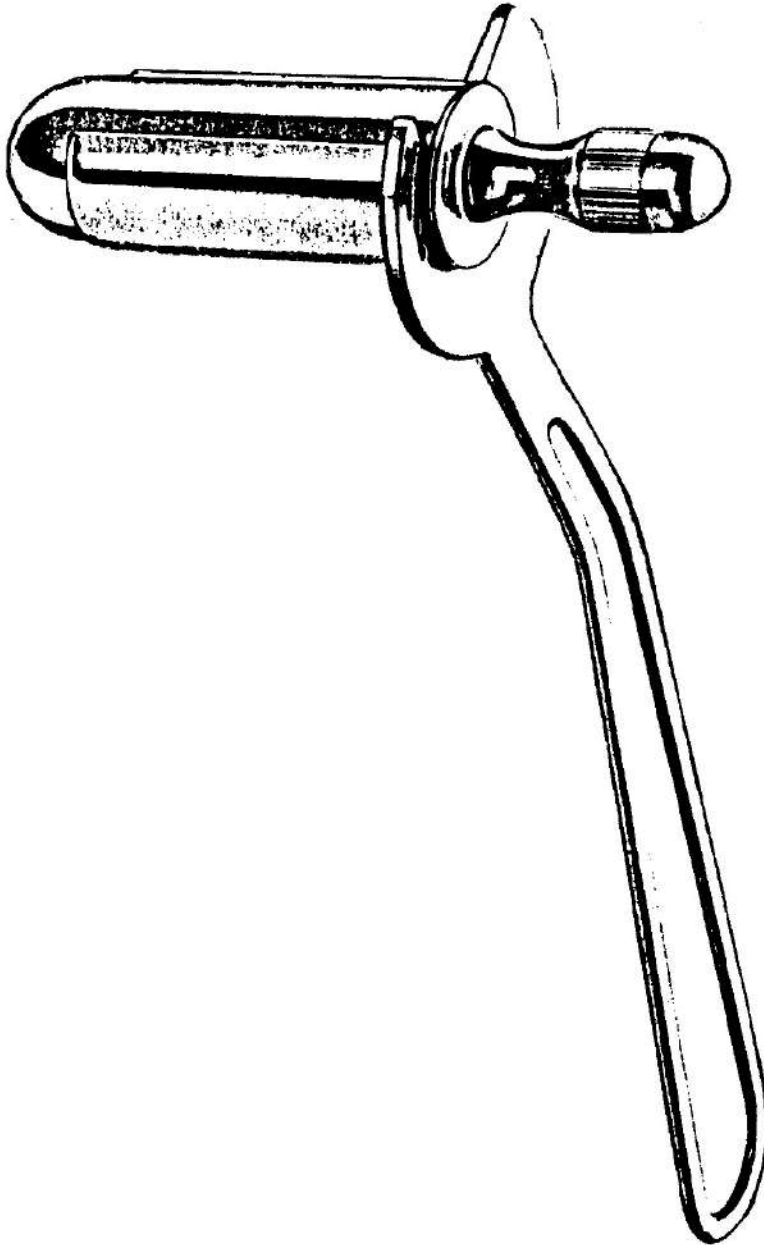
Fig. 1  
 EV69251-01

Fig. 2  
 EV69251-02

Fig. 3  
 EV69251-03

PRATT  
 21 cm, 8 1/4" EV69251-01 -  
 EV69251-03

Proktoskope  
Proctoscopes  
Proctoscopios  
Protoscopi

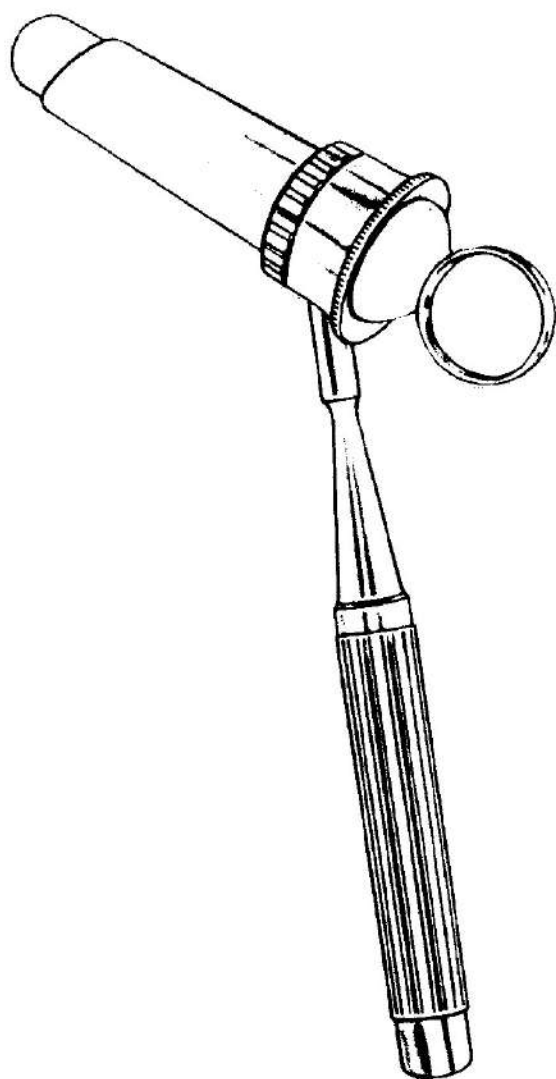


|            |   |                        |
|------------|---|------------------------|
| Ø          | L | FANSLER, 24 cm, 9 1/2" |
| 25 x 65 mm |   | EV69226-25             |
| 29 x 65 mm |   | EV69226-29             |
| 38 x 70 mm |   | EV69226-38             |



MORGAN

|            |         |         |
|------------|---------|---------|
| EV69227-01 | 17 mm Ø | L=65 mm |
| EV69227-02 | 17 mm Ø | L=80 mm |
| EV69227-03 | 20 mm Ø | L=65 mm |
| EV69227-04 | 20 mm Ø | L=80 mm |
| EV69227-05 | 24 mm Ø | L=65 mm |
| EV69227-06 | 24 mm Ø | L=80 mm |



BENSAUDE

|            |         |         |
|------------|---------|---------|
| EV69229-01 | 19 mm Ø | L=70 mm |
| EV69229-02 | 22 mm Ø | L=70 mm |



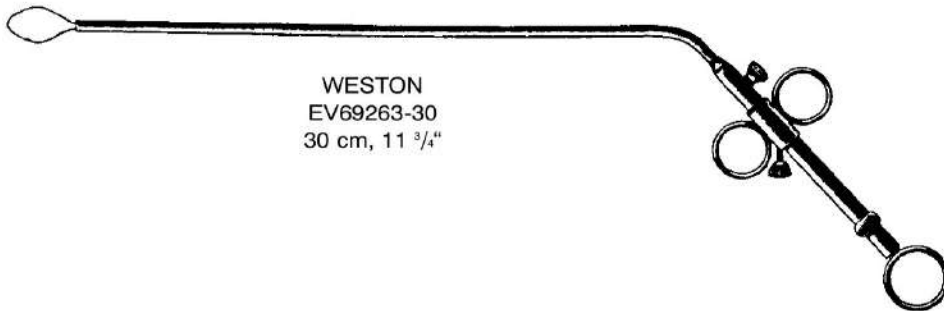
EV69228-01

Beleuchtungsstab für MORGAN  
 Illumination attachment for MORGAN  
 Mango con iluminación para MORGAN  
 Dispositivo Iluminativo per MORGAN

Rektal Absaugrohr, Rektalschnürer, Mastdarmbiopsiezangen  
 Rectal aspiration cannula, Rectal snare, Rectal Biopsy Specimen Forceps  
 Cánula de aspiración rectal, Cierra-nudo rectal, Pinzas para biopsia rectal  
 Cannula d'aspirazione rettale, Serranodi, Pinze taglianti per biopsia rettale



BUIE  
 EV69261-41  
 41 cm, 16"



WESTON  
 EV69263-30  
 30 cm, 11 3/4"



YEOMAN EV69301-28 -  
 EV69304-42

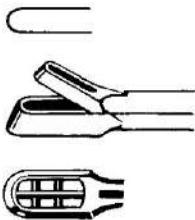


Fig. 1  
 EV69301-28 28 cm, 11"  
 EV69301-35 35 cm, 13 3/4"  
 EV69301-42 42 cm, 16 1/2"

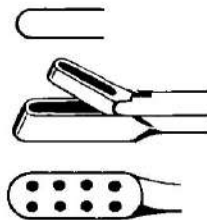


Fig. 2  
 EV69302-28 28 cm, 11"  
 EV69302-35 35 cm, 13 3/4"  
 EV69302-42 42 cm, 16 1/2"

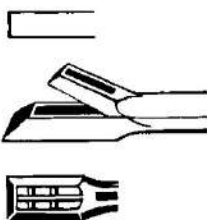


Fig. 3  
 EV69303-28 28 cm, 11"  
 EV69303-35 35 cm, 13 3/4"  
 EV69303-42 42 cm, 16 1/2"

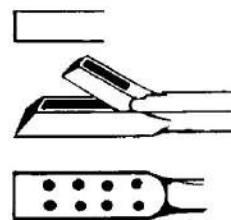
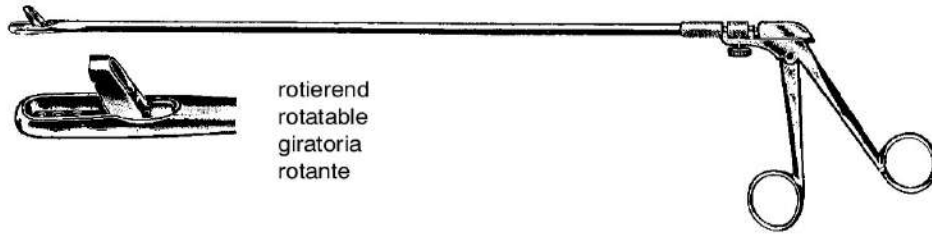


Fig. 4  
 EV69304-28 28 cm, 11"  
 EV69304-35 35 cm, 13 3/4"  
 EV69304-42 42 cm, 16 1/2"

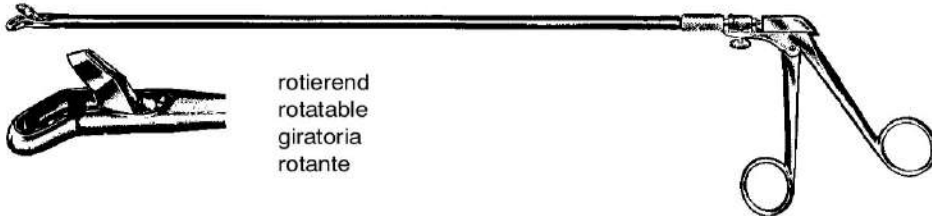
Mastdarm-Biopsiezangen, Hämorrhoidalzange  
 Rectal Biopsy Specimen Forceps, Haemorrhoidal Forceps  
 Pinzas para biopsia rectal, Pinzas-clamps hemorroidales  
 Pinze taglianti per biopsia rettale, Pinze per emorroidi



rotierend  
 rotatable  
 giratoria  
 rotante

YEOMANN

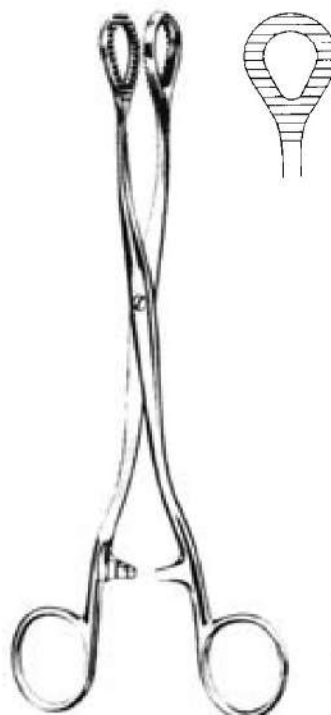
EV69311-23 23 cm, 9"  
 EV69311-33 33 cm, 13"  
 EV69311-40 40 cm, 15 3/4"



rotierend  
 rotatable  
 giratoria  
 rotante

TURREL

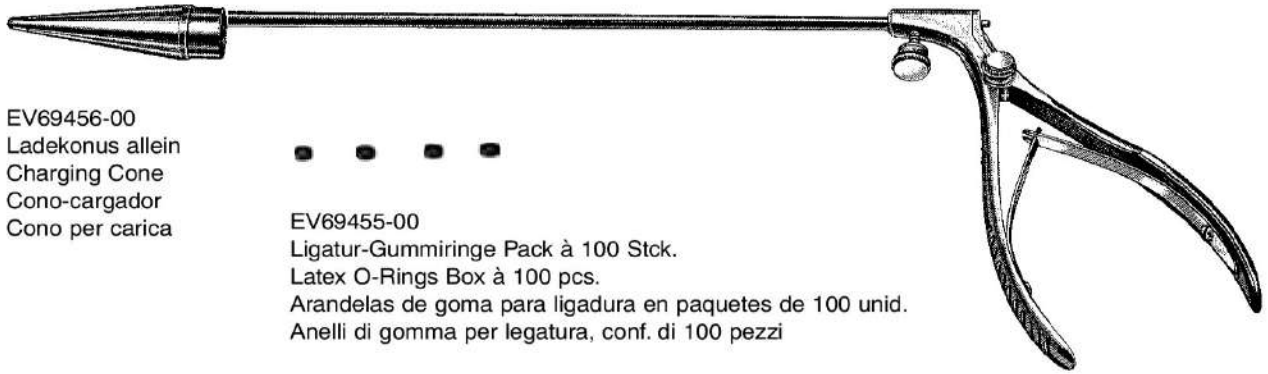
EV69321-23 23 cm, 9"  
 EV69321-33 33 cm, 13"  
 EV69321-40 40 cm, 15 3/4"



HEYWOOD-SMITH

EV69402-21 21 cm, 8 1/4"  
 EV69402-25 25 cm, 10"

Hämorrhoidal-Ligatoren, Hämorrhoidal-Fasszange  
 Haemorrhoidal Ligators, Haemorrhoidal Forceps  
 Ligadores para hemorroides, Pinzas-clamps para hemorroides  
 Legatori emorroidali, Pinze per emorroidi

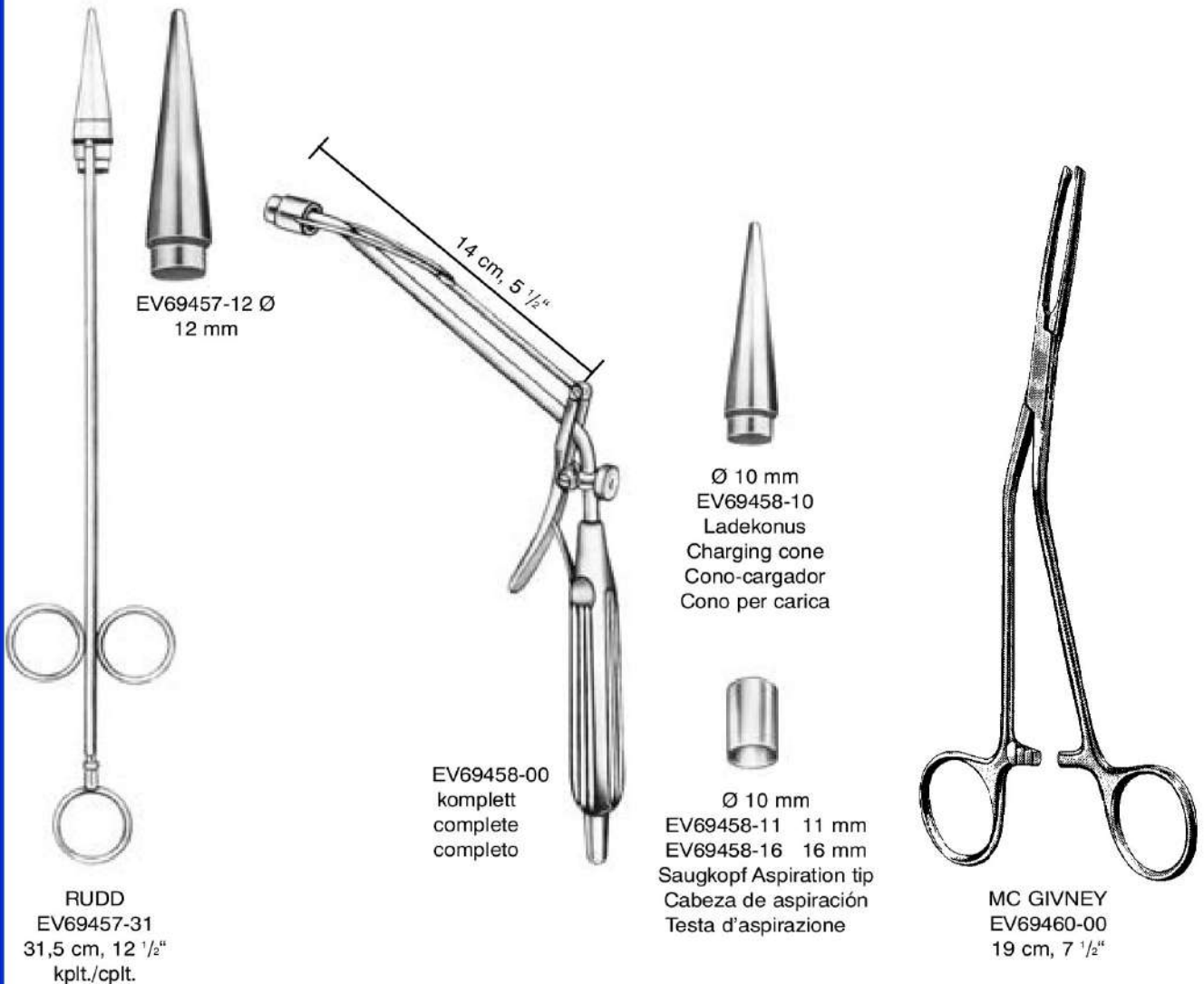


EV69456-00  
 Ladekonus allein  
 Charging Cone  
 Cono-cargador  
 Cono per carica



EV69455-00  
 Ligatur-Gummiringe Pack à 100 Stck.  
 Latex O-Rings Box à 100 pcs.  
 Arandelas de goma para ligadura en paquetes de 100 unid.  
 Anelli di gomma per legatura, conf. di 100 pezzi

MC GIVNEY  
 EV69450-18  
 18 cm, 7"



EV69457-12 Ø  
 12 mm

14 cm, 5 1/2"

Ø 10 mm  
 EV69458-10  
 Ladekonus  
 Charging cone  
 Cono-cargador  
 Cono per carica

EV69458-00  
 komplett  
 complete  
 completo

Ø 10 mm  
 EV69458-11 11 mm  
 EV69458-16 16 mm  
 Saugkopf Aspiration tip  
 Cabeza de aspiración  
 Testa d'aspirazione

RUDD  
 EV69457-31  
 31,5 cm, 12 1/2"  
 kplt./cplt.

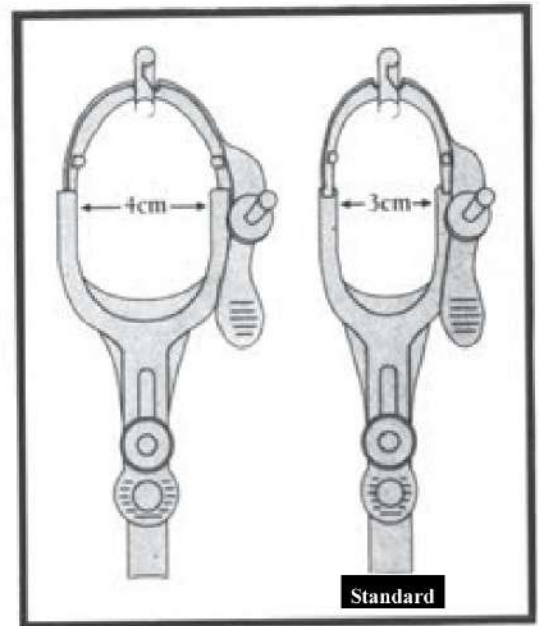
MC GIVNEY  
 EV69460-00  
 19 cm, 7 1/2"

Lateral-Scheidenspekula  
 Lateral Vaginal Retractor  
 Espécúlos vaginales  
 Specoli vaginali



EV71100-00

Lateralspreizer allein  
 Vaginal retractor lateral only  
 Espécúlo vaginal solo  
 Specolo vaginale laterale, solo



VU-MORE

| Fig. | mm     |            |
|------|--------|------------|
| 2    | 95x35  | EV71115-02 |
| 3    | 115x35 | EV71115-03 |

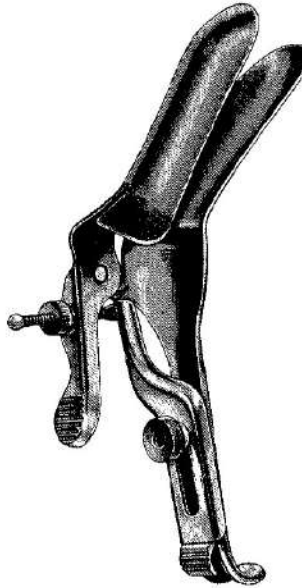


Scheidenspekula  
Vaginal Specula  
Espéculos vaginales  
Specoli vaginali



siehe Seite 569  
see page no. 569  
véase pagina no. 569  
vedi pagina nr. 569

VU-MORE



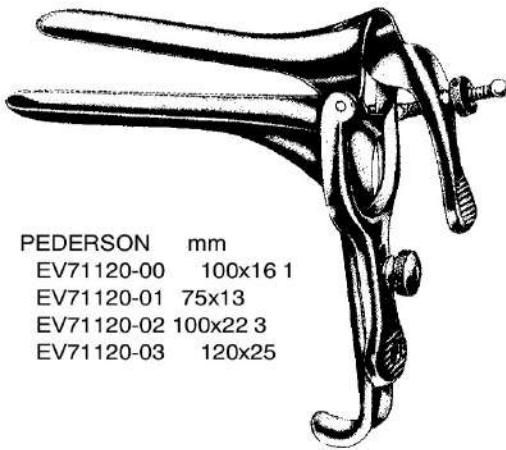
rechts offen  
open right-side  
abierto a la derecha  
aperta a destra

GRAVE

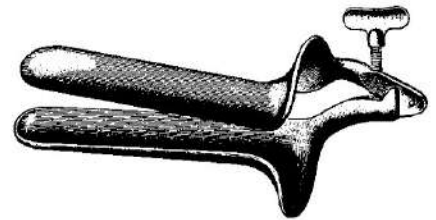
| Fig. | mm     | Standard     |
|------|--------|--------------|
| 1    | 75x20  | EV71110-01 2 |
|      | 95x35  | EV71110-02 3 |
|      | 115x35 | EV71110-03   |

GRAVE

|                                |
|--------------------------------|
| EV71116-02                     |
| mittel, medium, mediano, medio |
| 101x35 mm                      |



| Fig. | PEDERSON   | mm       |
|------|------------|----------|
|      | EV71120-00 | 100x16 1 |
|      | EV71120-01 | 75x13    |
| 2    | EV71120-02 | 100x22 3 |
|      | EV71120-03 | 120x25   |



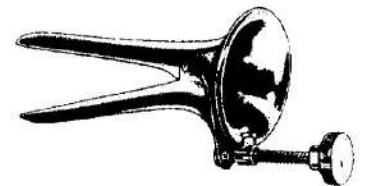
| Fig. | COLLIN     | mm       |
|------|------------|----------|
| 1    | EV71130-01 | 85x30    |
| 2    | EV71130-02 | 100x35 3 |
|      | EV71130-03 | 110x40   |



Seitliche Schraube  
Lateral Screw  
Tornillo lateral  
Vite laterale

CUSCO

| Fig. | mm     | Standard   |
|------|--------|------------|
| 1    | 75x32  | EV71140-01 |
| 2    | 85x35  | EV71140-02 |
| 3    | 100x35 | EV71140-03 |
| 4    | 75x17  | EV71142-04 |

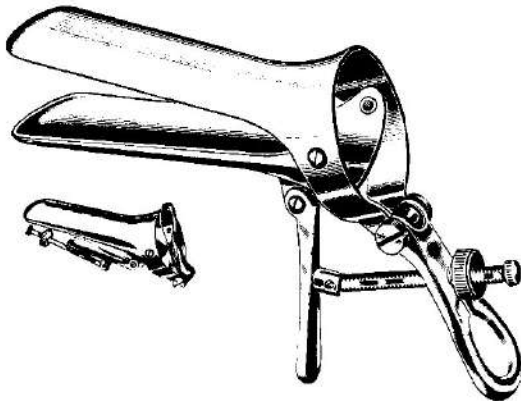


COLLIN  
EV71132-00  
65x10 mm

für Jungfrauen for virgin  
para vírgenes per  
vergini

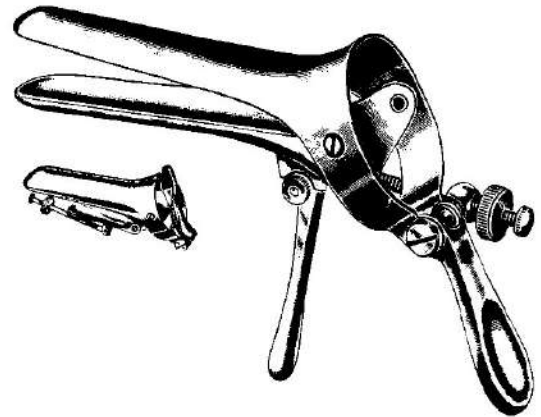
Scheidenspekula  
 Vaginal Specula  
 Espéculos vaginales  
 Specoli vaginali

Mittelschraube  
 Central Screw  
 Tornillo central  
 Vite centrale

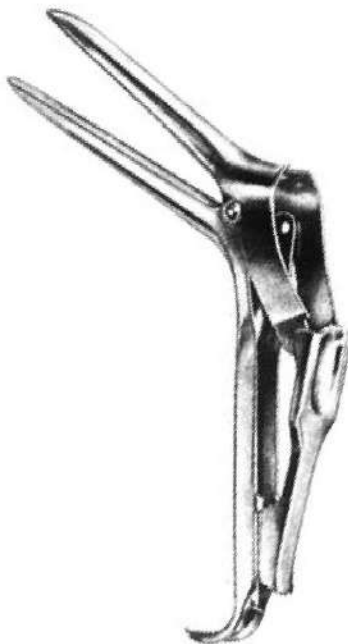


| Fig. | CUSCO      | mm     |
|------|------------|--------|
| 1    | EV71150-01 | 75x32  |
| 2    | EV71150-02 | 85x35  |
| 3    | EV71150-03 | 100x37 |

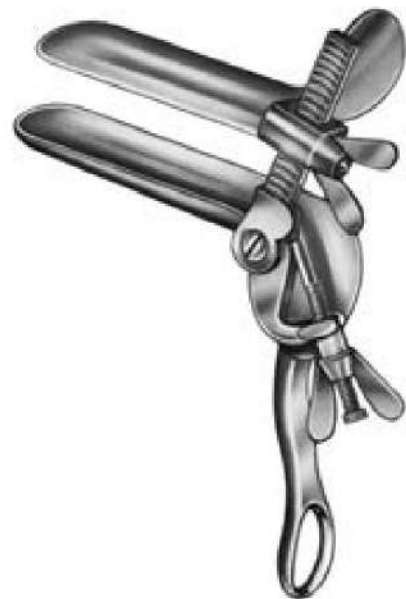
Schweizer Modell  
 Swiss Pattern  
 Modelo suizo  
 Modello svizzero



| Fig. | CUSCO      | mm          |
|------|------------|-------------|
| 1    | EV71160-01 | 90x23-25    |
| 2    | EV71160-02 | 100x25-27 3 |
|      | EV71160-03 | 110x27-30   |



| SEMM       | mm               |
|------------|------------------|
| EV71161-17 | 100 x 17 - 20 mm |
| EV71161-25 | 100 x 25 - 30 mm |



| Fig. | TRÉLAT     | mm     |
|------|------------|--------|
| 1    | EV71170-01 | 85x33  |
| 2    | EV71170-02 | 95x35  |
| 3    | EV71170-03 | 115x43 |

Scheidenspekula  
Vaginal Specula  
Espéculos vaginales  
Specoli vaginali

Satz bestehend aus je 1 Spekula und 1 Halter  
Set consisting of 1 specula and 1 retractor  
Juego de 1 espéculo y 1 valva  
Serie da 1 specolo e 1 valva

Spekula  
Speculum  
Espéculo  
Specolo

Halter  
Retractor  
Valva  
Valve

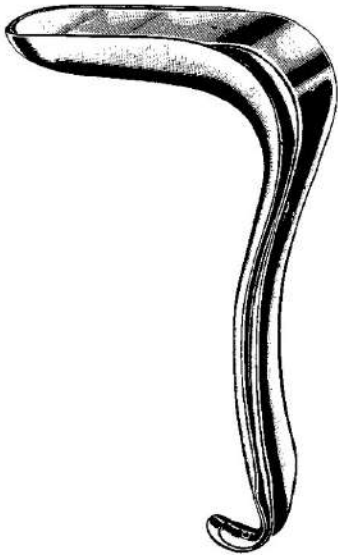


Fig. KRISTELLER  
1 EV71210-01  
2 EV71210-02 3  
EV71210-03

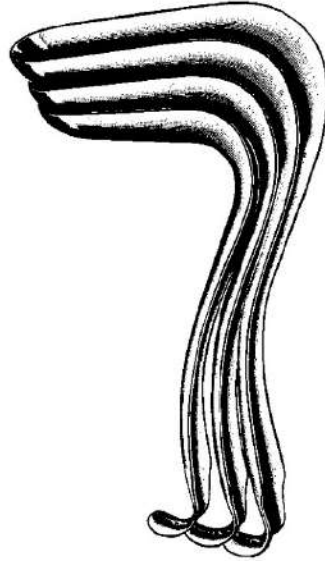


Fig. KRISTELLER mm  
1 EV71211-01 70x27  
2 EV71211-02 80x30  
3 EV71211-03 90x36



Fig. KRISTELLER mm  
1 EV71212-01 75x23  
2 EV71212-02 85x26  
3 EV71212-03 100x32

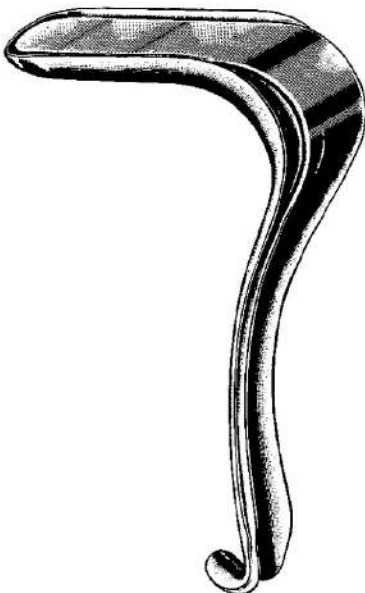


Fig. KRISTELLER  
00 EV71240-00  
0 EV71240-10  
1 EV71240-01  
2 EV71240-02  
3 EV71240-03

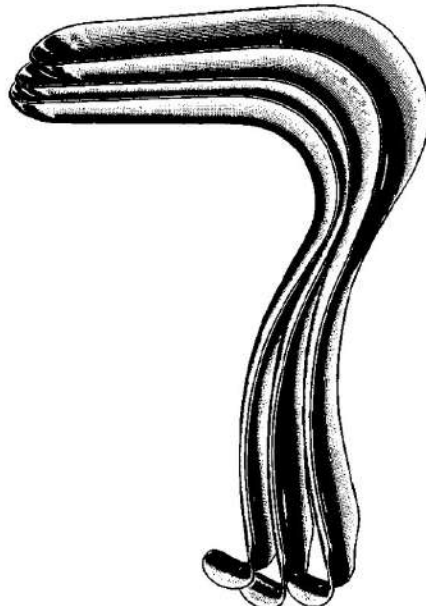


Fig. KRISTELLER mm  
00 EV71241-00 110x18  
0 EV71241-10 110x21  
1 EV71241-01 110x27  
2 EV71241-02 110x30  
3 EV71241-03 110x36

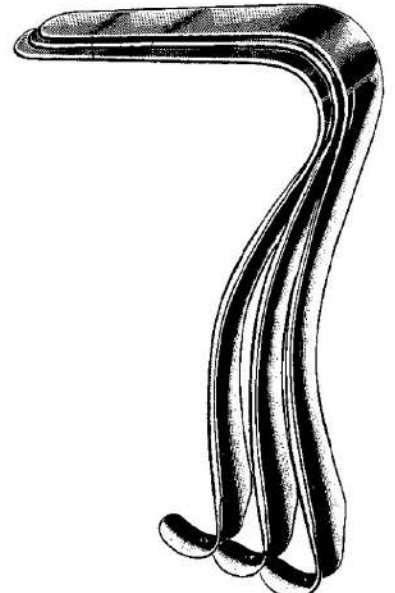
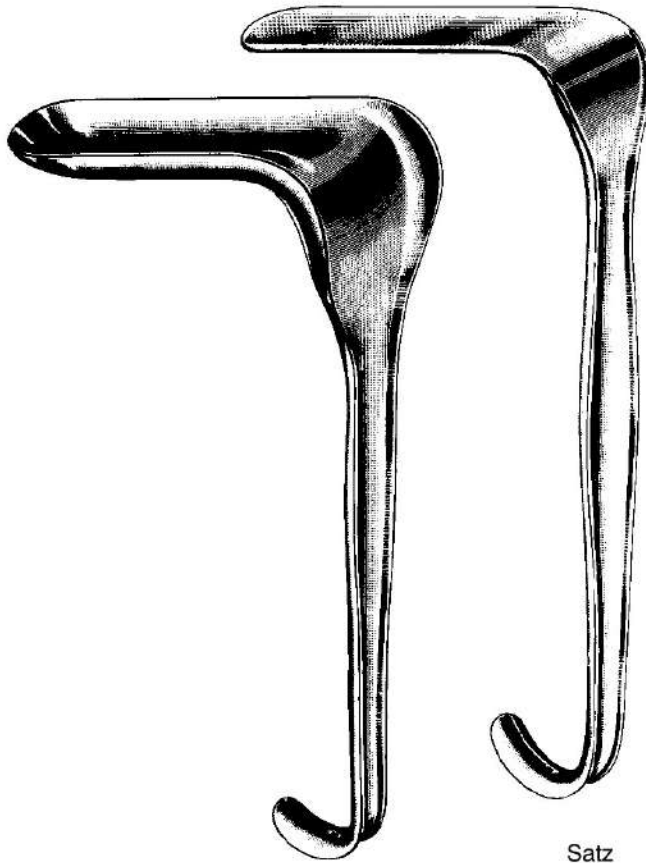


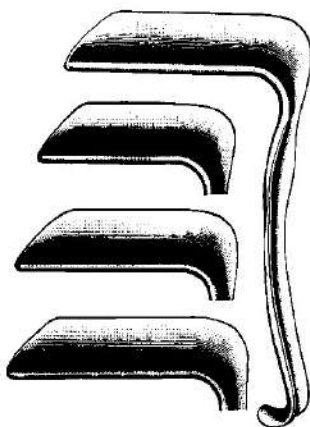
Fig. KRISTELLER mm  
00 EV71242-00 115x14  
0 EV71242-10 115x17  
1 EV71242-01 115x23  
2 EV71242-02 115x26  
3 EV71242-03 115x32

Scheidenspekula  
Vaginal Specula  
Espéculos vaginales  
Specoli vaginali



KALLMORGEN EV71260-01 -  
EV71262-02

| Fig. | Serie      | Speculo    | mm    | Valve      | mm    |
|------|------------|------------|-------|------------|-------|
| 1    | EV71260-01 | EV71261-01 | 70x40 | EV71262-01 | 70x33 |
| 2    | EV71260-02 | EV71261-02 | 90x40 | EV71262-02 | 90x33 |



JACKSON

| Fig. | Serie      | mm     |
|------|------------|--------|
| 1    | EV71271-01 | 75x38  |
| 2    | EV71271-02 | 90x38  |
| 3    | EV71271-03 | 100x38 |



Fig. SIMS mm 1

|            |       |   |
|------------|-------|---|
| EV71281-01 | 63x32 | 2 |
| EV71281-02 | 76x32 | 3 |
| EV71281-03 | 89x38 |   |

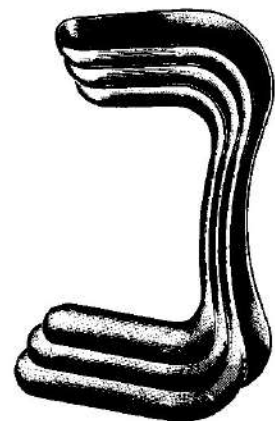
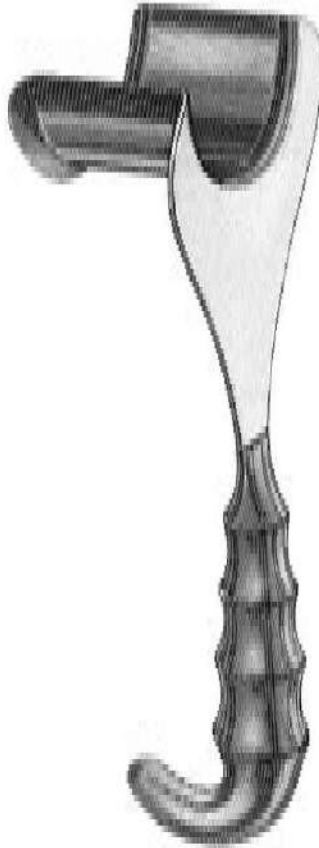


Fig. SIMS mm

|   |            |          |   |
|---|------------|----------|---|
| 1 | EV71291-01 | 60x25+30 | 2 |
|   | EV71291-02 | 70x30+35 | 3 |
|   | EV71291-03 | 80x35+40 |   |

Set EV71291-00 (Fig. 1,2,3)



DELEE  
EV71300-01  
23,5 cm, 9 1/4"

leicht hohl  
slightly concave  
ligeramente concavos  
leggermente concavi

| Fig. |            | mm     |
|------|------------|--------|
| 1    | EV71301-01 | 55x35  |
| 2    | EV71301-02 | 85x35  |
| 3    | EV71301-03 | 115x35 |

| Fig. |            | mm     |
|------|------------|--------|
| 1    | EV71303-01 | 55x45  |
| 2    | EV71303-02 | 85x45  |
| 3    | EV71303-03 | 115x45 |
| 4    | EV71303-04 | 160x45 |
| 5    | EV71303-05 | 180x45 |

| Fig. |            | mm     |
|------|------------|--------|
| 1    | EV71305-01 | 55x60  |
| 2    | EV71305-02 | 85x60  |
| 3    | EV71305-03 | 115x60 |
| 4    | EV71305-04 | 160x60 |
| 5    | EV71305-05 | 180x60 |



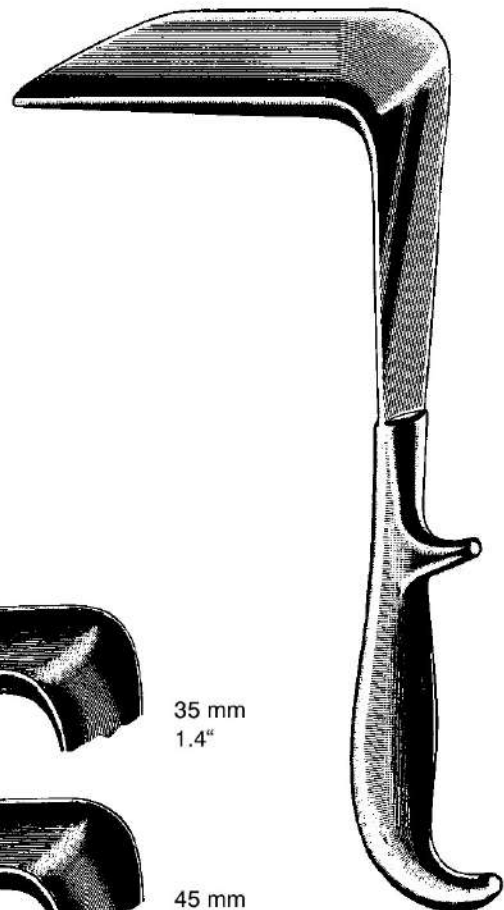
35 mm  
1.4"



45 mm  
1.8"



60 mm  
2.4"



DOYEN  
24 cm, 9 1/2"

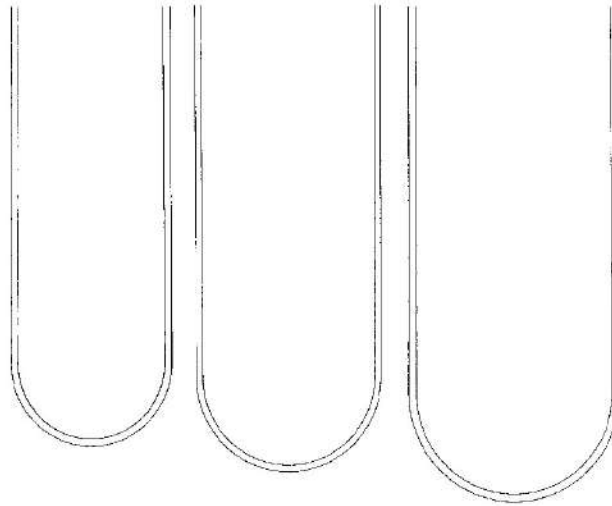


EV71306-01 - EV71306-03

EV71306-01  
 80 x 30 mm

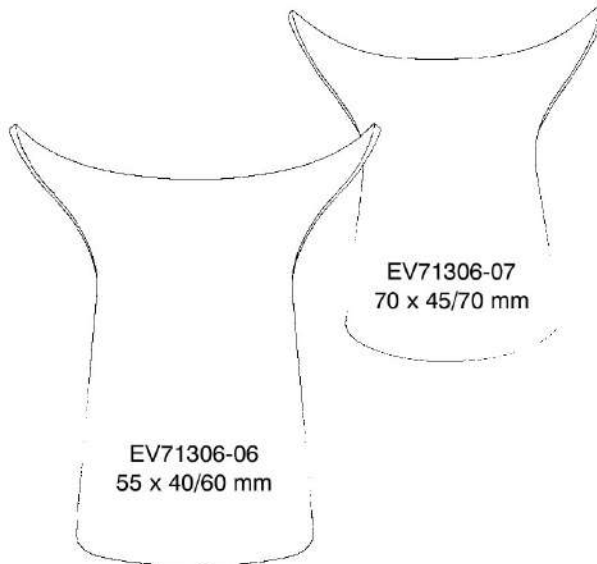
EV71306-02  
 85 x 35 mm

EV71306-03  
 90 x 40 mm



EV71306-04  
 Gewicht 400 gr  
 weight 400 grs  
 peso 400 grs  
 peso 400 grs

EV71306-05  
 Gewicht 800 gr  
 weight 800 grs  
 peso 800 grs  
 peso 800 grs



EV71306-06  
 55 x 40/60 mm

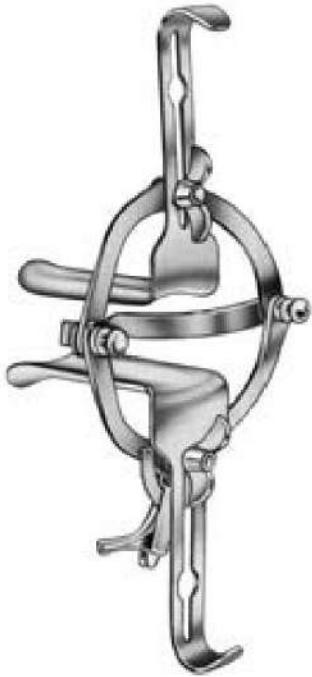
EV71306-07  
 70 x 45/70 mm

SCHERBAK  
 EV71306-00  
 Set komplett  
 complete set  
 juego completo  
 set completo



EV71306-08  
 Griff, handle,  
 mango, manico

Scheidenspekula  
Vaginal Specula  
Espéculos vaginales  
Specoli vaginali



O'SULLIVAN-O'CONNOR  
EV71308-00



Fig. 1 = 45 x 17 mm EV71308-01  
Fig. 2 = 90 x 37 mm EV71308-02  
Fig. 3 = 90 x 45 mm EV71308-03

71308-00

komplett bestehend aus:

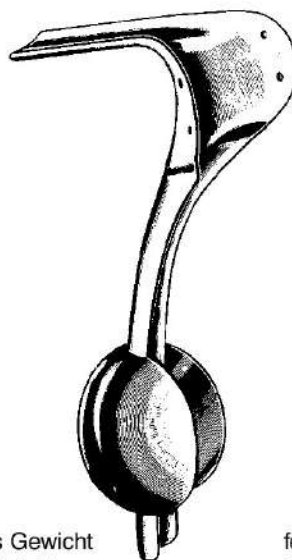
1 Rahmen mit 2 beweglichen Seitenvalven  
3 austauschbare Mittelvalven Fig. 1-3

1 frame with 2 mobile lateral blades  
3 interchangeable blades Fig. 1-3

1 Marco con 2 separadores móviles laterales  
3 separadores centrales intercambiables fig. 1-3

1 telaio regolabile con 2 valve laterali mobili  
3 valve intercambiabili fig. 1-3

EV71308-04  
Rahmen allein  
Frame only  
Marco solo  
Telaio solo



abnehmbares Gewicht  
Detachable Weight  
Peso desmontable  
Peso smontabile

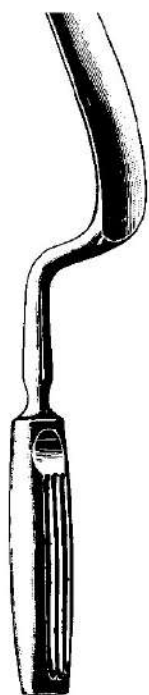
EV71307-00  
1,4 kg  
75 x 38 mm

AUVARD  
24 cm, 9 1/2"

festes Gewicht  
Fixed Weight  
Peso fijo  
Peso fisso

EV71309-00  
1,4 kg  
105 x 38 mm

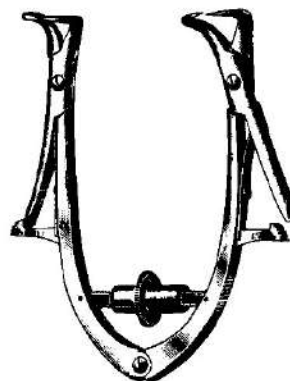
Scheidenspekula, Endospekula  
 Vaginal Specula, Endospecula  
 Espécúlos vaginales, Endo-espécúlos  
 Specoli vaginali, Endospecoli



EV71319-28 29 cm, 11 1/2" 100x25MM  
 EV71310-25 28 cm, 11" 100x28 MM  
 BREISKY

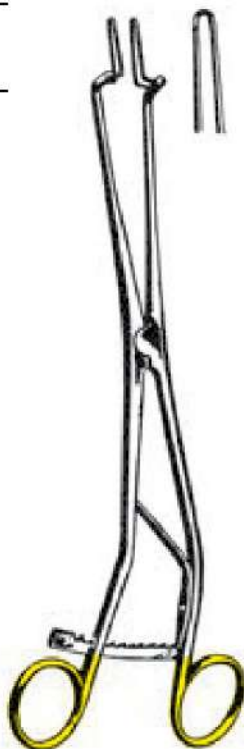


LANDAU

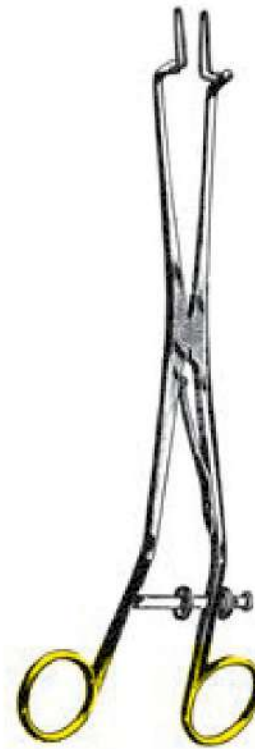


JOLL (FRIEDMANN)  
 EV71351-10 10 cm, 4"  
 EV71351-15 15 cm, 6"

|        |            |                |                              |
|--------|------------|----------------|------------------------------|
| 100x20 | EV71310-20 | 28 cm, 11"     |                              |
| 100x38 | EV71319-38 | 29 cm, 11 1/2" | 100x30 EV71310-30 28 cm, 11" |
| 100x35 | EV71310-35 | 28 cm, 11"     |                              |
| 100x40 | EV71310-40 | 28 cm, 11"     |                              |
| 100x20 | EV71313-20 | 33 cm, 13"     |                              |
| 100x25 | EV71313-25 | 33 cm, 13"     |                              |
| 100x30 | EV71313-30 | 33 cm, 13"     |                              |
| 100x35 | EV71313-35 | 33 cm, 13"     |                              |
| 100x40 | EV71313-40 | 33 cm, 13"     |                              |
| 105x40 | EV71315-40 | 35 cm, 13 3/4" |                              |



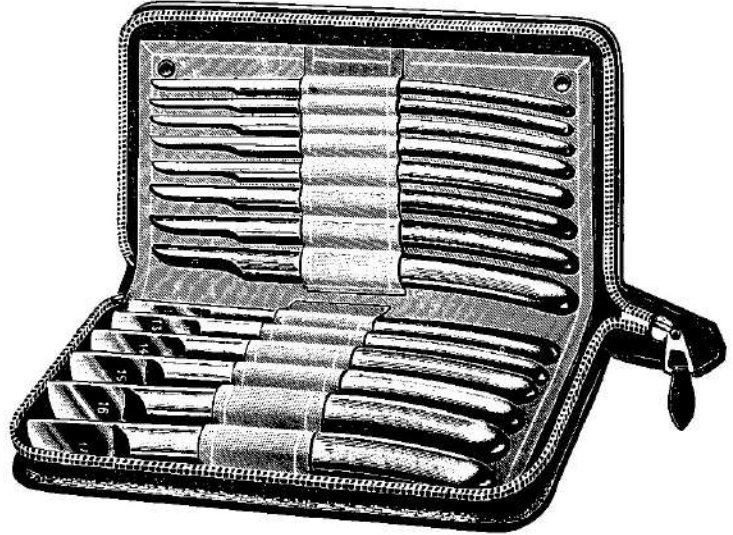
KOGAN  
 EV71360-24 3 mm 24 cm, 9 1/2"  
 EV71361-24 4 mm 24 cm, 9 1/2"  
 EV71362-24 5 mm 24 cm, 9 1/2"



KOGAN  
 EV71363-24 3 mm 24 cm, 9 1/2"  
 EV71364-24 4 mm 24 cm, 9 1/2"  
 EV71365-24 5 mm 24 cm, 9 1/2"

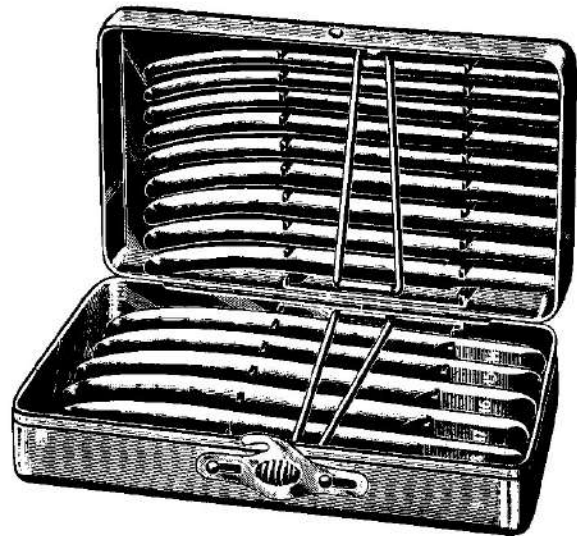


Uterus Dilatatore  
 Uterine Dilators  
 Dilatadores uterinos  
 Dilatatori uterini



| mm Ø | HEGAR                 | mm Ø |
|------|-----------------------|------|
| 1    | EV71410-01 EV71415-01 | 1,5  |
| 2    | EV71410-02 EV71415-02 | 2,5  |
| 3    | EV71410-03 EV71415-03 | 3,5  |
| 4    | EV71410-04 EV71415-04 | 4,5  |
| 5    | EV71410-05 EV71415-05 | 5,5  |
| 6    | EV71410-06 EV71415-06 | 6,5  |
| 7    | EV71410-07 EV71415-07 | 7,5  |
| 8    | EV71410-08 EV71415-08 | 8,5  |
| 9    | EV71410-09 EV71415-09 | 9,5  |
| 10   | EV71410-10 EV71415-10 | 10,5 |
| 11   | EV71410-11 EV71415-11 | 11,5 |
| 12   | EV71410-12 EV71415-12 | 12,5 |
| 13   | EV71410-13 EV71415-13 | 13,5 |
| 14   | EV71410-14 EV71415-14 | 14,5 |
| 15   | EV71410-15 EV71415-15 | 15,5 |
| 16   | EV71410-16 EV71415-16 | 16,5 |
| 17   | EV71410-17 EV71415-17 | 17,5 |
| 18   | EV71410-18 EV71415-18 | 18,5 |
| 19   | EV71410-19 EV71415-19 | 19,5 |
| 20   | EV71410-20            |      |
| 21   | EV71410-21            |      |
| 22   | EV71410-22            |      |
| 23   | EV71410-23            |      |
| 24   | EV71410-24            |      |
| 25   | EV71410-25            |      |
| 26   | EV71410-26            |      |
| 27   | EV71410-27 28         |      |
|      | EV71410-28            |      |
| 29   | EV71410-29 30         |      |
|      | EV71410-30            |      |

HEGAR EV71405-14 4-17 mm  
 14 St./pces./pzas./pezzi

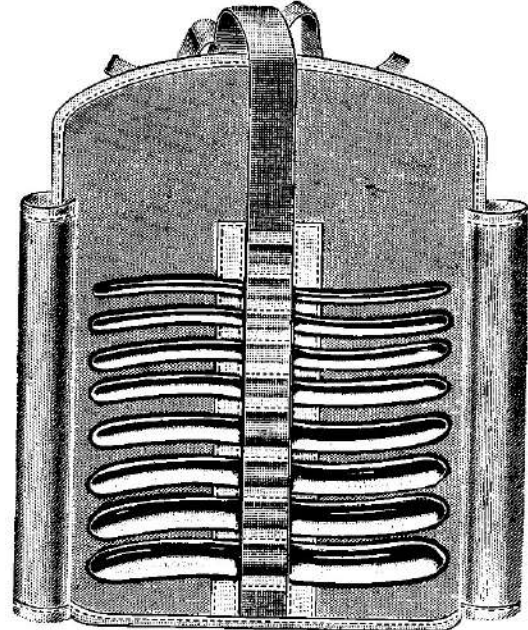
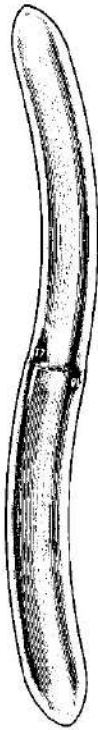


mm HEGAR  
 4-17 EV71406-14 14 St./pces./pzas./pezzi  
 1-26 EV71406-26 26 St./pces./pzas./pezzi

EV71404-14 Satz/Set/Juego/Set  
 EV71410-04 - EV71410-17 = 14

EV71404-26 Satz/Set/Juego/Set  
 EV71410-01 - EV71410-26 = 26

in Metalletui, in metal case,  
 en estuche de metal, in astuccio metallico



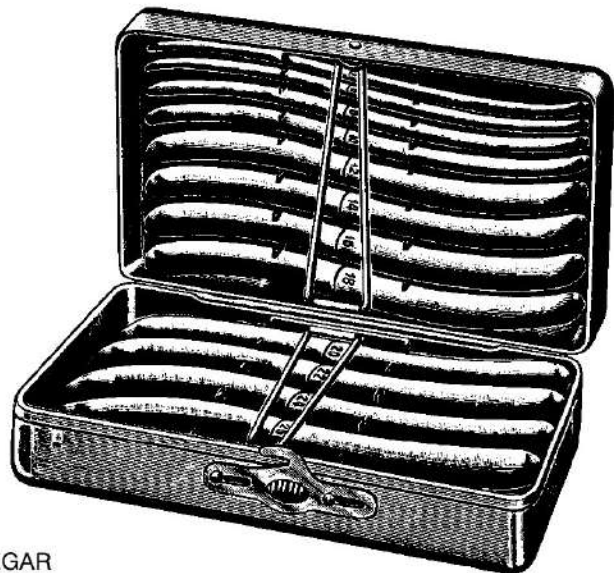
| mm    | HEGAR      |
|-------|------------|
| 1/ 2  | EV71420-01 |
| 3/ 4  | EV71420-03 |
| 5/ 6  | EV71420-05 |
| 7/ 8  | EV71420-07 |
| 9/10  | EV71420-09 |
| 11/12 | EV71420-11 |
| 13/14 | EV71420-13 |
| 15/16 | EV71420-15 |
| 17/18 | EV71420-17 |
| 19/20 | EV71420-19 |
| 21/22 | EV71420-21 |
| 23/24 | EV71420-23 |
| 25/26 | EV71420-25 |

| mm          | HEGAR      | 8 St./pces./pzas./pezzi |
|-------------|------------|-------------------------|
| 3/4 - 17/18 | EV71425-08 |                         |

in Stofftasche, in khaki roll,  
 en bolsa de tela, in borsa di tela

EV71424-08 Satz/Set/Juego/Set  
 EV71420-03 - EV71420-17 =  
 8 3/4 - 17/18 mm

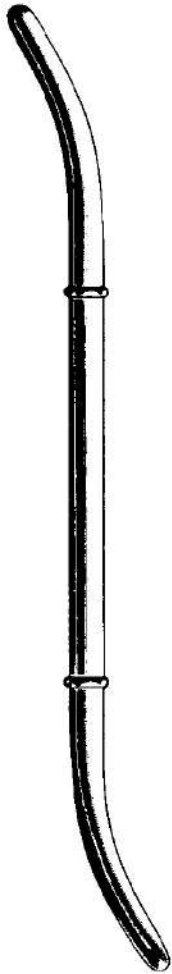
EV71424-13 Satz/Set/Juego/Set  
 EV71420-01 - EV71420-25 =  
 13 1/2 - 25/26 mm



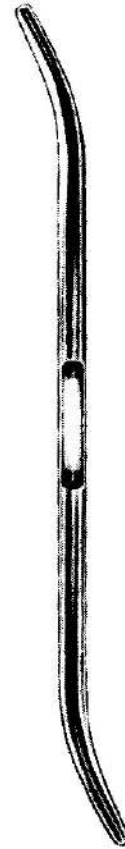
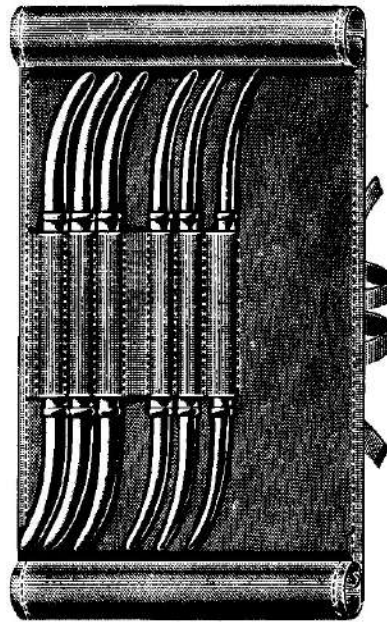
| mm          | HEGAR      | 8 St./pces./pzas./pezzi | 13 St./pces./pzas./pezzi |
|-------------|------------|-------------------------|--------------------------|
| 3-4 - 17/18 | EV71426-08 |                         |                          |
| 1/2 - 25/26 | EV71426-13 |                         |                          |

in Metalletui, in metal case,  
 en estuche de metal, in astuccio metallico

Uterus Dilatatoren  
 Uterine Dilators  
 Dilatadores uterinos  
 Dilatatori uterini



in Stofftasche  
 in khaki roll  
 en bolsa de tela  
 in borsa di tela

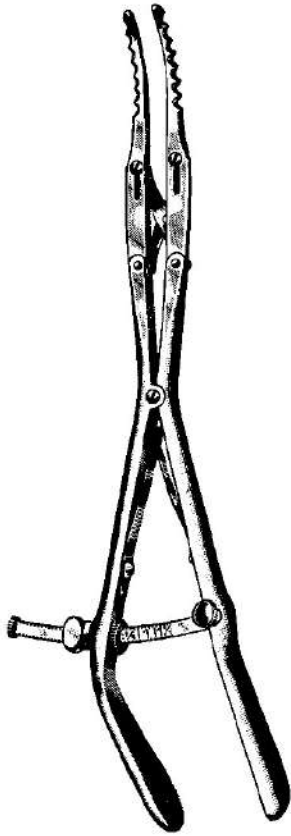


| Fig.  | mm/Ø   | HANK       |
|-------|--------|------------|
| 9/10  | 4,5/5  | EV71430-10 |
| 11/12 | 5,5/6  | EV71430-12 |
| 13/14 | 6,5/7  | EV71430-14 |
| 15/16 | 7,5/8  | EV71430-16 |
| 17/18 | 8,5/9  | EV71430-18 |
| 19/20 | 9,5/10 | EV71430-20 |

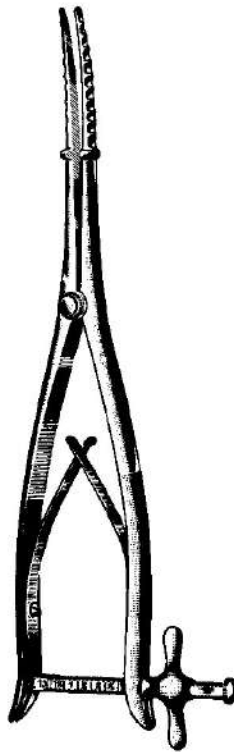
EV71436-06  
 Satz, set, juego, serie = 6

| Fig./U.S. | mm/Ø      | PRATT      |
|-----------|-----------|------------|
| 13/15     | 4,5/5     | EV71438-13 |
| 17/19     | 5,6/6,3   | EV71438-17 |
| 21/23     | 7/7,6     | EV71438-21 |
| 25/27     | 8,3/9     | EV71438-25 |
| 29/31     | 9,6/10,3  | EV71438-29 |
| 33/35     | 11/11,6   | EV71438-33 |
| 37/39     | 12,3/13   | EV71438-37 |
| 41/43     | 13,6/14,3 | EV71438-41 |

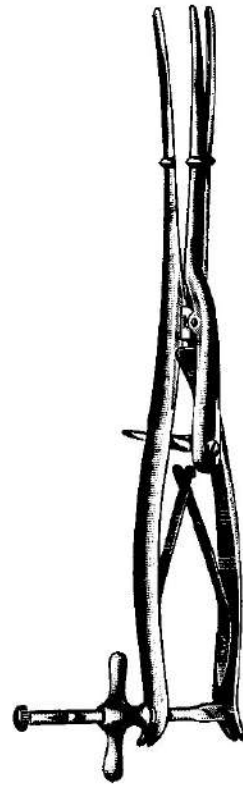
EV71438-00  
 Satz, set, juego, serie = 8



GOODELL  
EV71441-34  
34 cm, 13 1/2"



WYLIE  
EV71443-29  
29 cm, 11 1/2"



SIMS  
EV71445-29  
29 cm, 11 1/2"



Hakenzangen

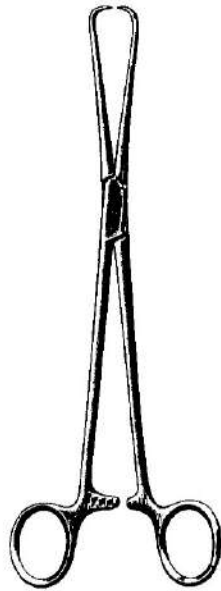
Tenaculum Forceps

Pinzas para coger el cuello del útero

Pinze per abbassare il collo dell'utero



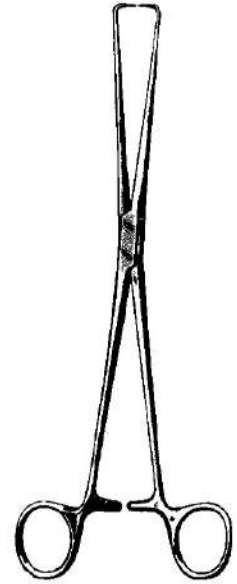
ADAIR  
EV71500-18  
19 cm, 7 1/2"



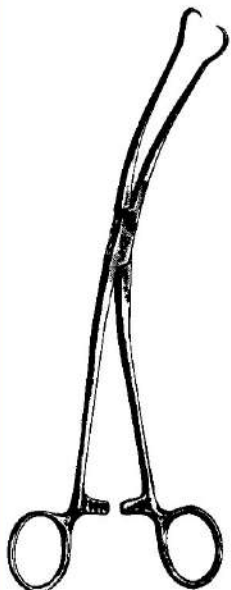
SCHRÖDER (POZZI)  
EV71502-25  
25 cm, 10"



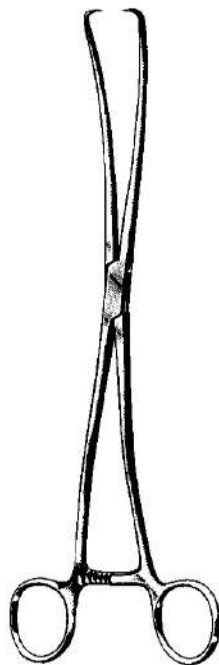
POZZI-PALMER  
EV71503-25  
25 cm, 10"



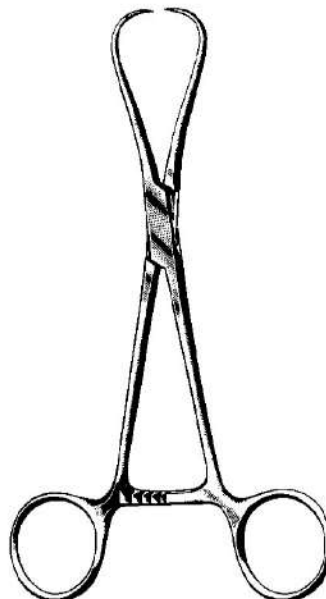
BRAUN  
EV71504-25  
25 cm, 10"



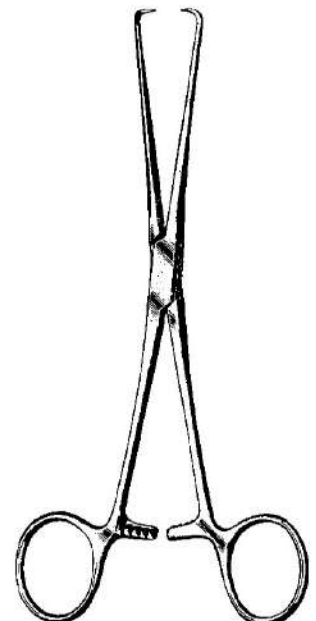
SKENE  
EV71505-24  
24 cm, 9 1/2"



DUPLAY  
EV71507-28  
28 cm, 11"

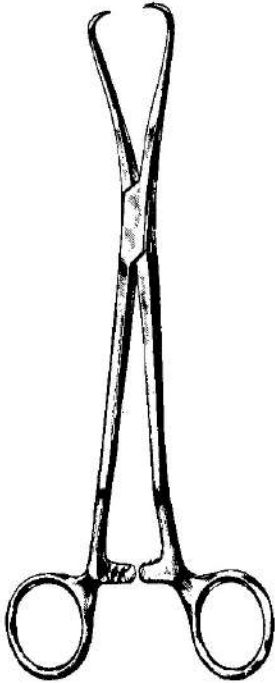


STAUDE-MOORE  
EV71508-17  
17 cm, 6 3/4"

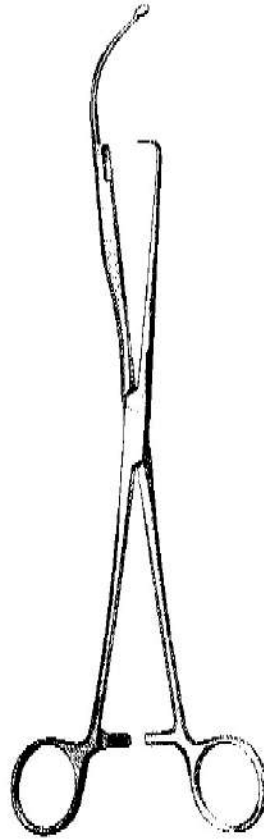


BARRETT  
EV71510-18  
18 cm, 7"

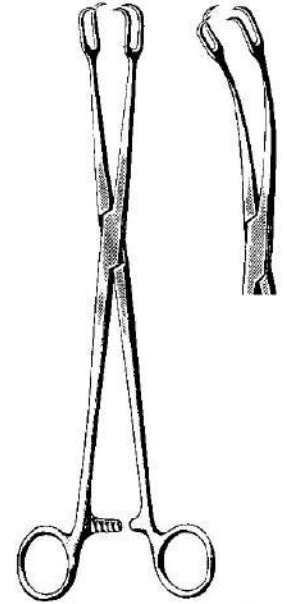
Hakenzangen  
 Tenaculum Forceps, Vulsellum Forceps  
 Pinzas para coger el cuello del útero  
 Pinze per abbassare il collo dell'utero



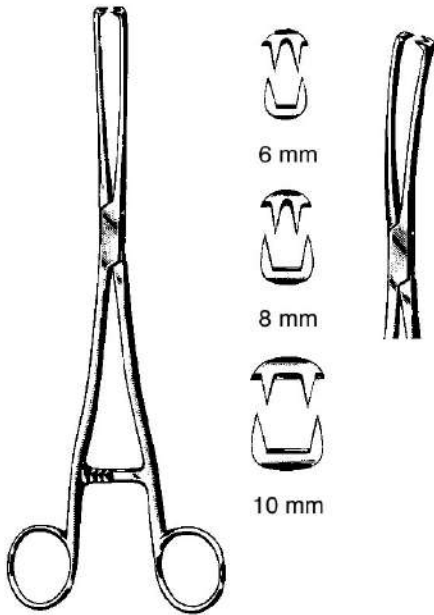
JARCHO  
 EV71512-20 20  
 cm, 8"



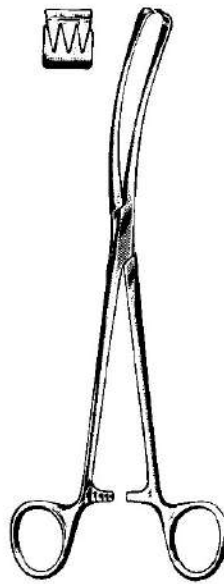
HULKA  
 EV71512-28  
 28 cm, 11"



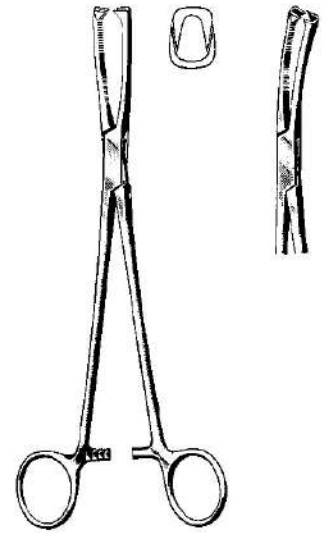
SCHRÖDER  
 EV71514-24 EV71515-24  
 24 cm, 9 1/2"



MUSEUX  
 EV71524-06 6 mm EV71525-06  
 EV71524-08 8 mm EV71525-08  
 EV71524-10 10 mm EV71525-10  
 24 cm, 9 1/2"



TEALE  
 EV71531-23  
 23 cm, 9"



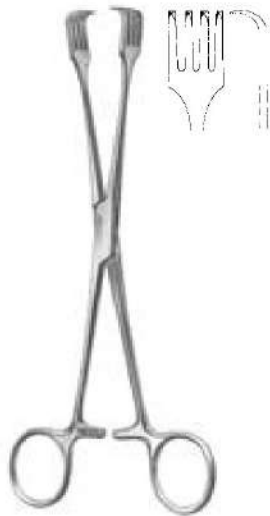
JACOBS  
 EV71532-21 EV71533-21  
 21 cm, 8 1/4"

Hakenzangen

Tenaculum Forceps, Vulsellum Forceps

Pinzas para coger el cuello del útero

Pinze per abbassare il collo dell'utero



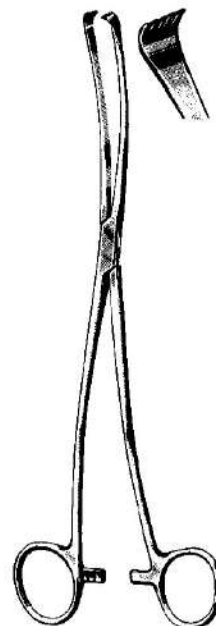
CZERNY  
EV71536-21 20  
cm, 8"



PRATT  
EV71536-28  
28 cm, 11"

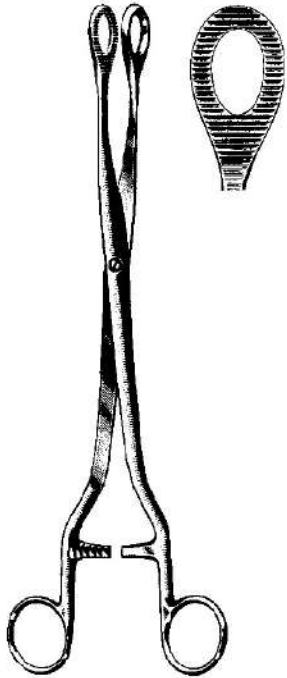


SCHRÖDER  
EV71537-27  
27 cm, 10 1/2"

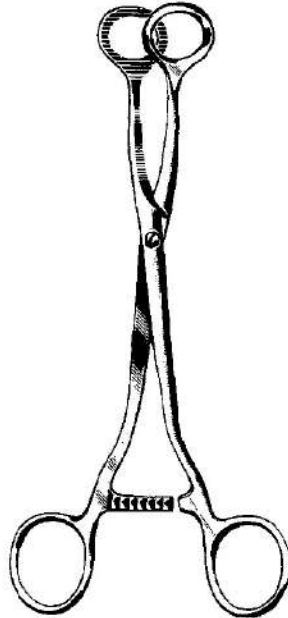


IOWA  
EV71539-26  
26 cm, 10 1/4"

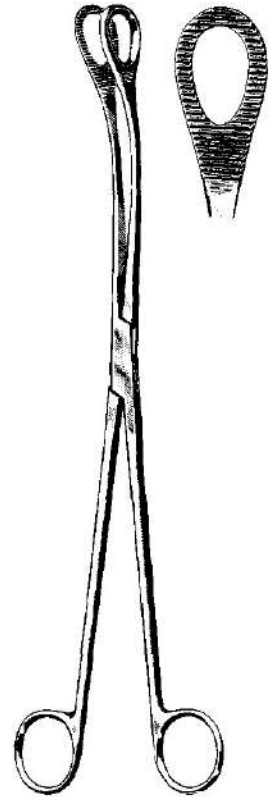
Uterus Polypenzangen, Uterus-Faßzangen  
 Uterine Polypus Forceps, Uterine Elevating Forceps  
 Pinzas para pólipos uterinos, Pinzas para el útero  
 Pinze per polipi uterini, Pinze per afferrare l'utero



NOTO  
 EV71540-27  
 27 cm, 10 1/2"



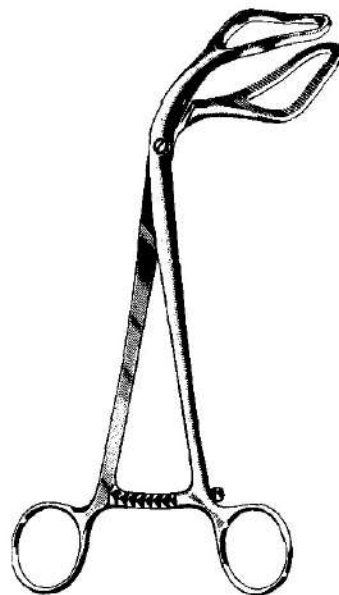
DOYEN  
 EV71542-20  
 20 cm, 8"



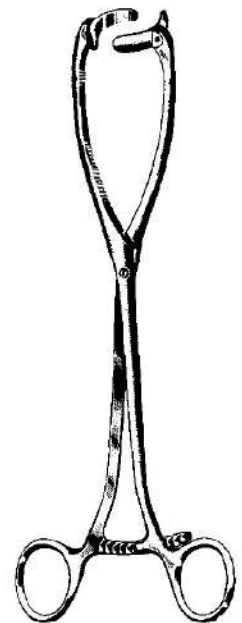
KELLY  
 EV71543-32  
 32 cm, 12 3/4"



DARTIGUES  
 EV71545-27  
 27 cm, 10 1/2"



SOMER  
 EV71547-23  
 23 cm, 9"



COLLIN  
 EV71549-25  
 25 cm, 10"



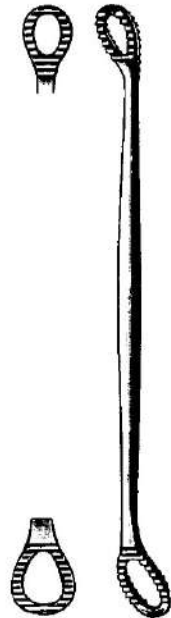
Amniotom, Uterus Depressoren, Uterus-Sonden  
 Amniotome, Uterine Depressors, Uterine Sounds  
 Amniótomo, Depresores uterinos, Histerómetros  
 Amniotomo, Depressori uterini, Isterometri



BEACHAM  
 EV71559-26  
 26 cm, 10 1/4"



BRAUN  
 EV71565-28  
 28 cm, 11"



SIMS  
 EV71567-26  
 26 cm, 10 1/4"



fest  
 rigid  
 rigido  
 rigida

SIMS

EV71580-32  
 32 cm, 12 3/4"



biegsam  
 malleable  
 maleable  
 malleabile

EV71581-32



fest  
 rigid  
 rigido  
 rigida

MARTIN

EV71582-32  
 32 cm, 12 3/4"



biegsam  
 malleable  
 maleable  
 malleabile

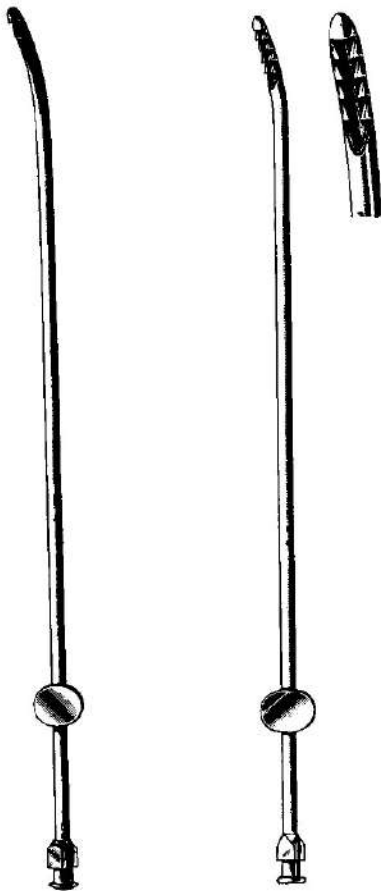
EV71583-32



COLLIN  
 EV71584-28  
 28 cm, 11"



VALLEIX  
 EV71585-25  
 25 cm, 10"

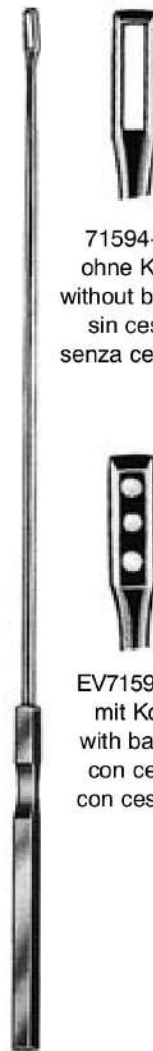


RANDALL  
 EV71590-04  
 24 cm, 9 1/2"  
 Ø 4 mm

NOVAK  
 EV71592-01 Ø 1 mm  
 EV71592-02 Ø 2 mm  
 EV71592-03 Ø 3 mm  
 EV71592-04 Ø 4 mm



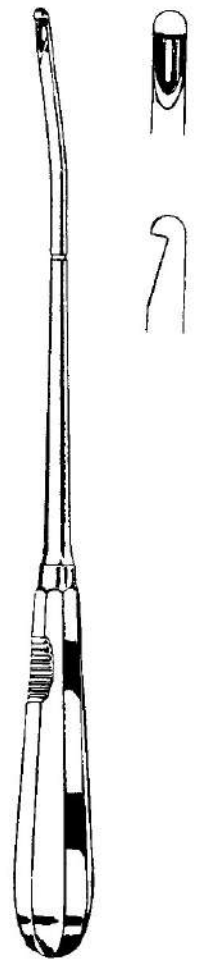
HEANY  
 EV71593-00  
 22,5 cm, 9"



71594-40  
 ohne Korb  
 without basket  
 sin cesta  
 senza cestello

EV71596-40  
 mit Korb  
 with basket  
 con cesta  
 con cestello

KEVORKIAN  
 4,0 mm  
 30 cm, 11 3/4"



MOD. MUENCHEN  
 EV71598-27 27  
 cm, 10 1/2"

mit Luer-Lock Ansatz  
 with Luer-Lock connection  
 con conexión Luer-Lock  
 con raccordo Luer-Lock

Biopsiezangen  
 Biopsy Forceps  
 Pinzas para biopsia  
 Pinze taglienti per biopsia



SCHUMACHER  
 24 cm, 9 1/2"



SCHUBERT  
 EV71604-21 21 cm, 8 1/4"  
 EV71604-28 28 cm, 11"



SCHUBERT  
 EV71605-26  
 26 cm, 10 1/4"



THOMS-GAYLOR  
 EV71606-24  
 24 cm, 9 1/2"

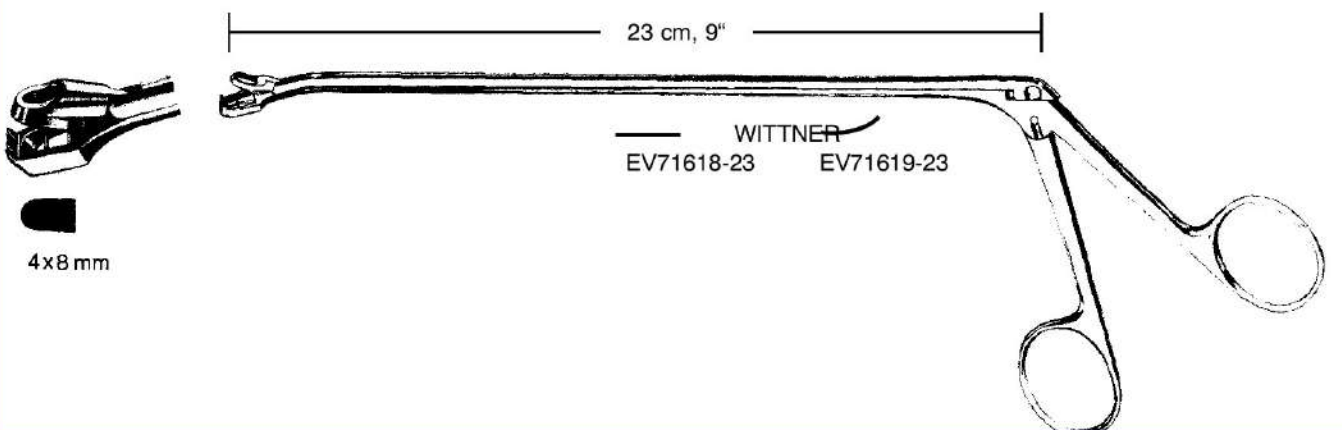
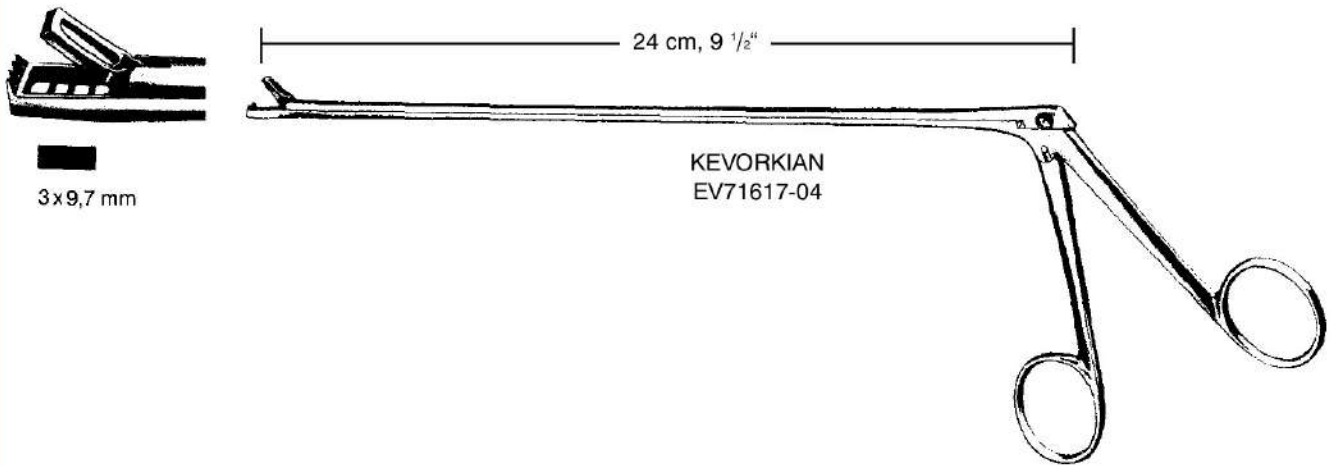
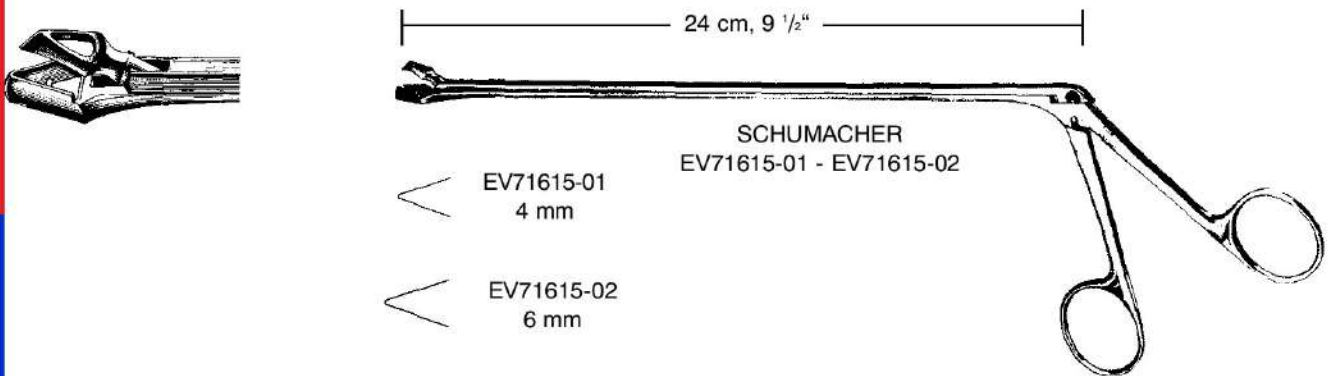
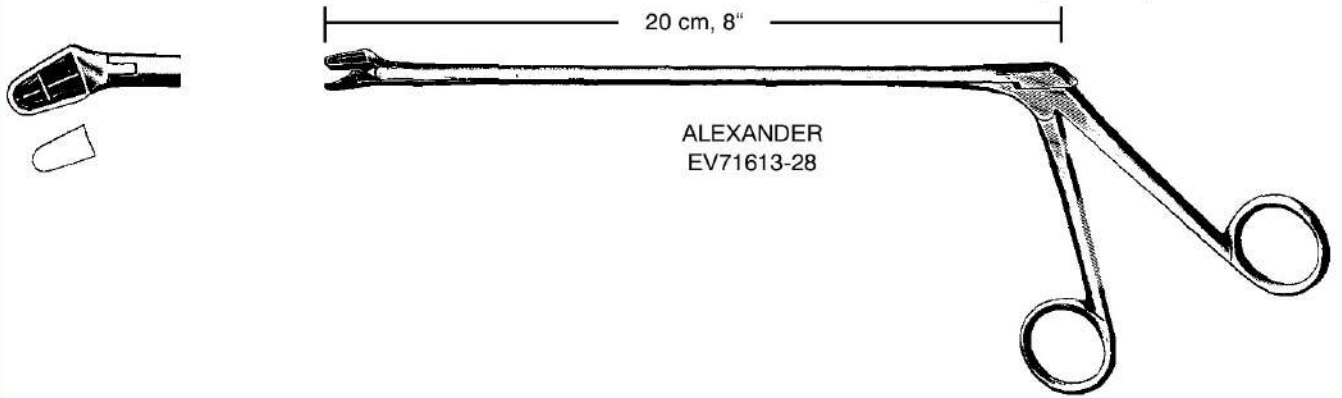


van DOREN  
 EV71611-25  
 25 cm, 10"

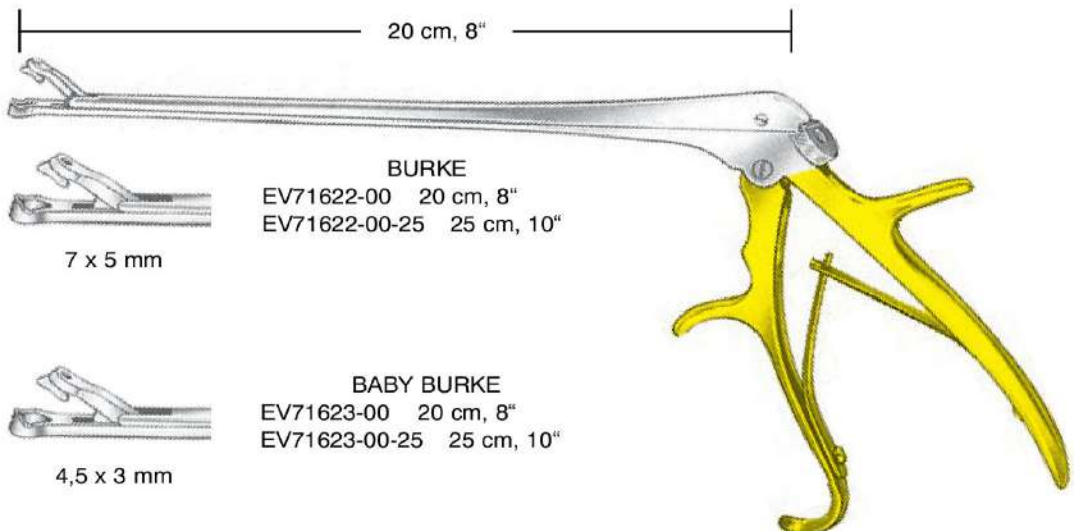
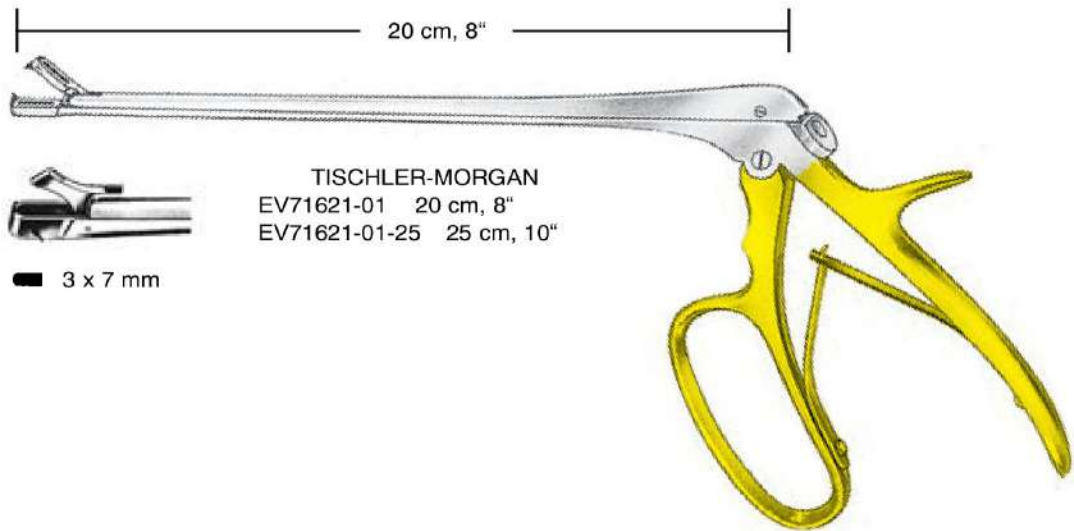
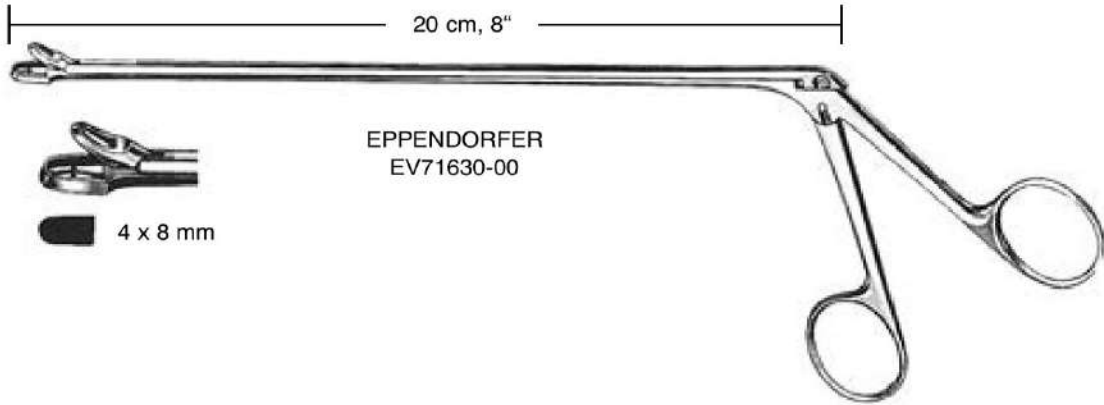


FAURE  
 EV71612-21  
 21 cm, 8 1/4"

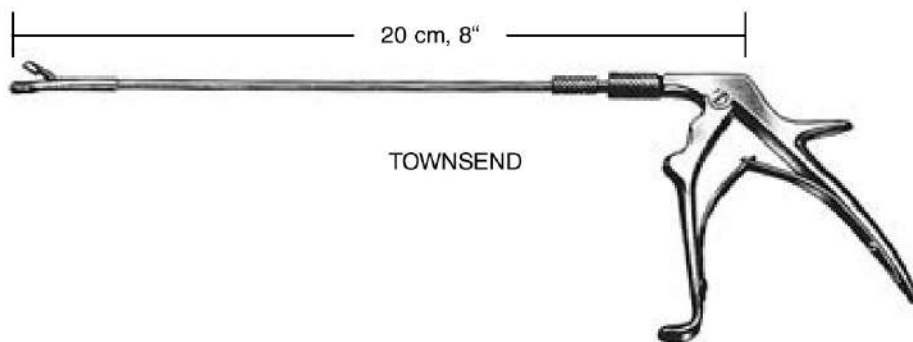
Uterus Biopsiezangen  
 Biopsy Specimen Forceps  
 Pinzas para biopsia  
 Pinze per biopsia



Uterus Biopsiezangen  
 Biopsy Specimen Forceps  
 Pinzas sacabocado p. biopsia  
 Pinze per biopsia



Uterus Biopsiezangen  
 Biopsy Specimen Forceps  
 Pinzas sacabocado p. biopsia  
 Pinze per biopsia



TOWNSEND

EV71624-10  
 Griff allein  
 Handle only  
 Mango solo  
 Manico solo



Fig. 1

TISCHLER-MORGAN



Fig. 6

TISCHLER-UP



Fig. 3

oval ● 3,7x5 mm



Fig. 7

TISCHLER-DOWN



Fig. 4

KEVORKIAN



Fig. 8

MINI-TOWNSEND-UP



Fig. 5

mini



Fig. 9

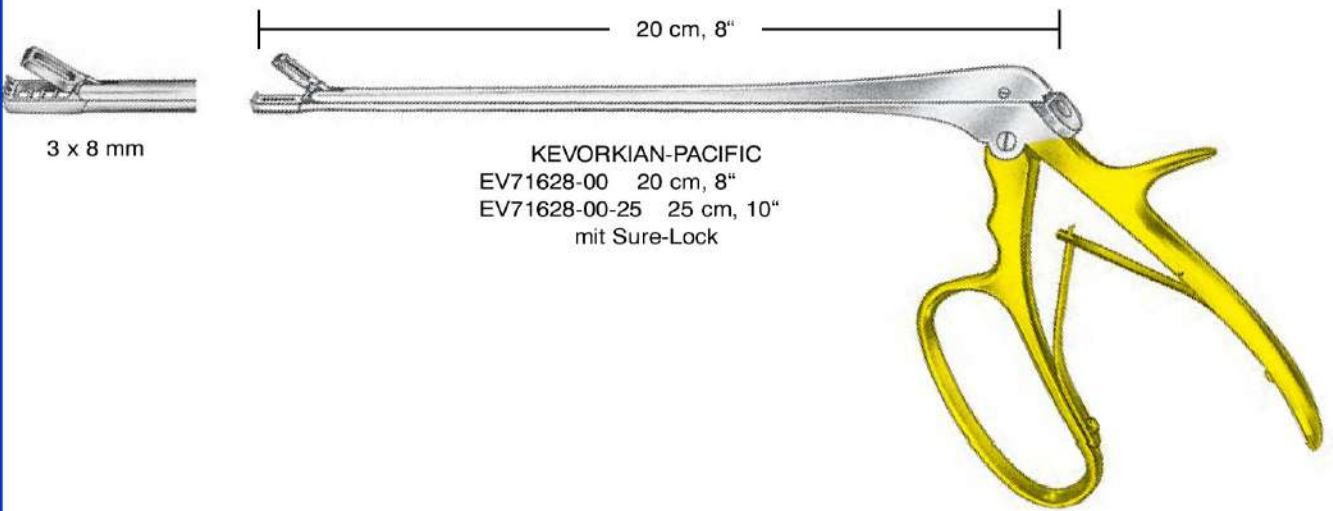
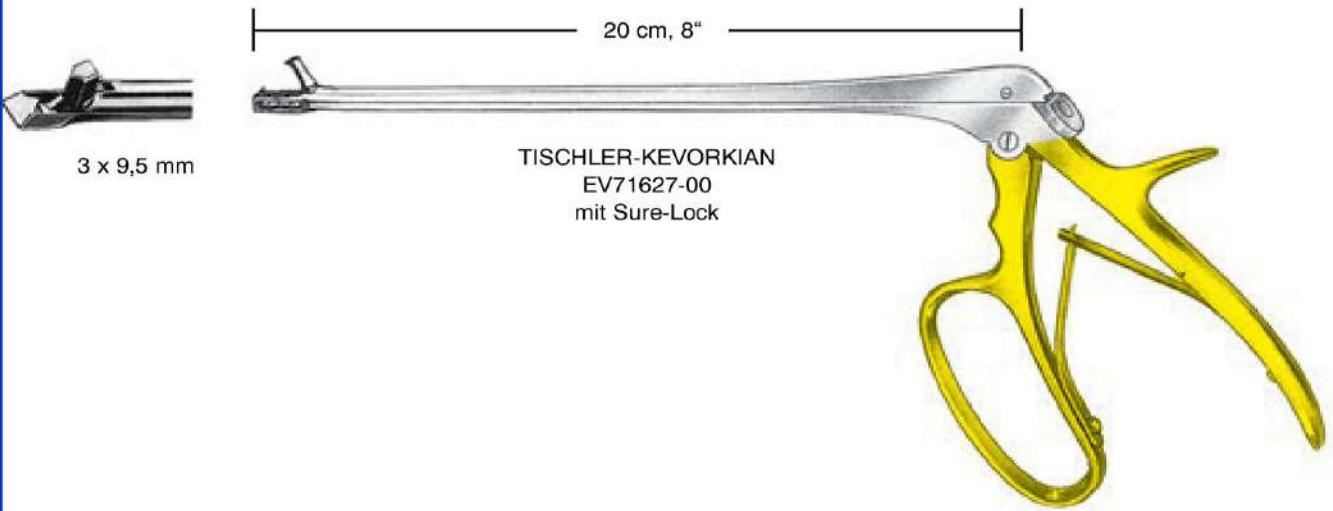
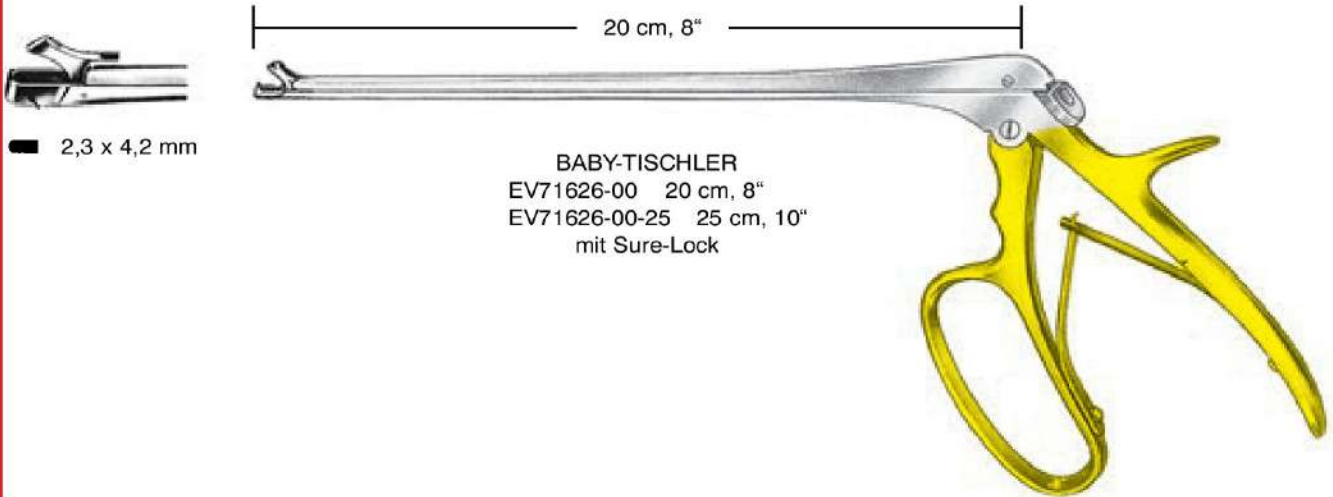
MINI-TOWNSEND-DOWN

| Fig. | Strumento completo | Asta operativa sola |
|------|--------------------|---------------------|
| 1    | EV71624-01         | EV71624-11          |
| 3    | EV71624-03         | EV71624-13          |
| 4    | EV71624-04         | EV71624-14          |
| 5    | EV71624-05         | EV71624-15          |
| 6    | EV71624-06         | EV71624-16          |
| 7    | EV71624-07         | EV71624-17          |
| 8    | EV71624-08         | EV71624-18          |
| 9    | EV71624-09         | EV71624-19          |

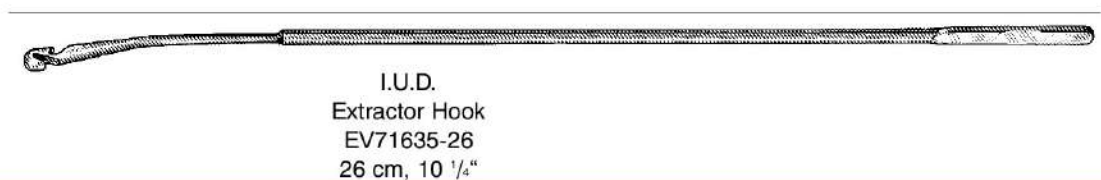
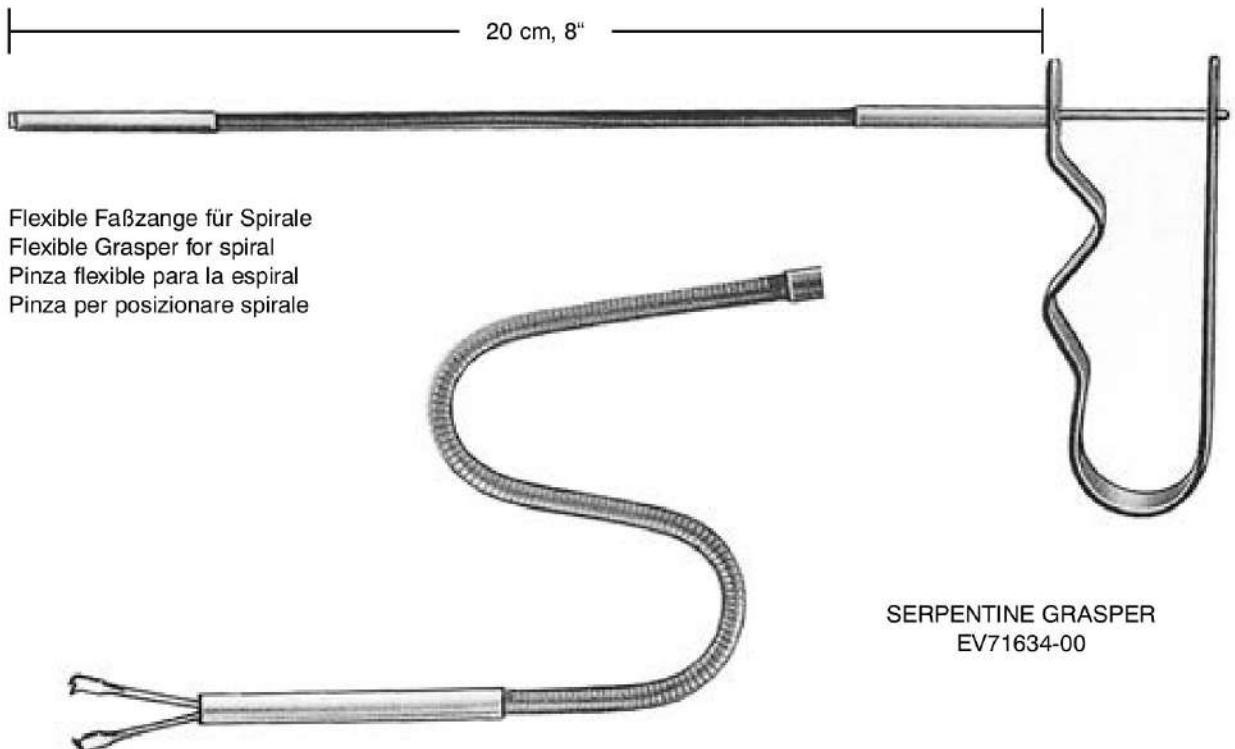
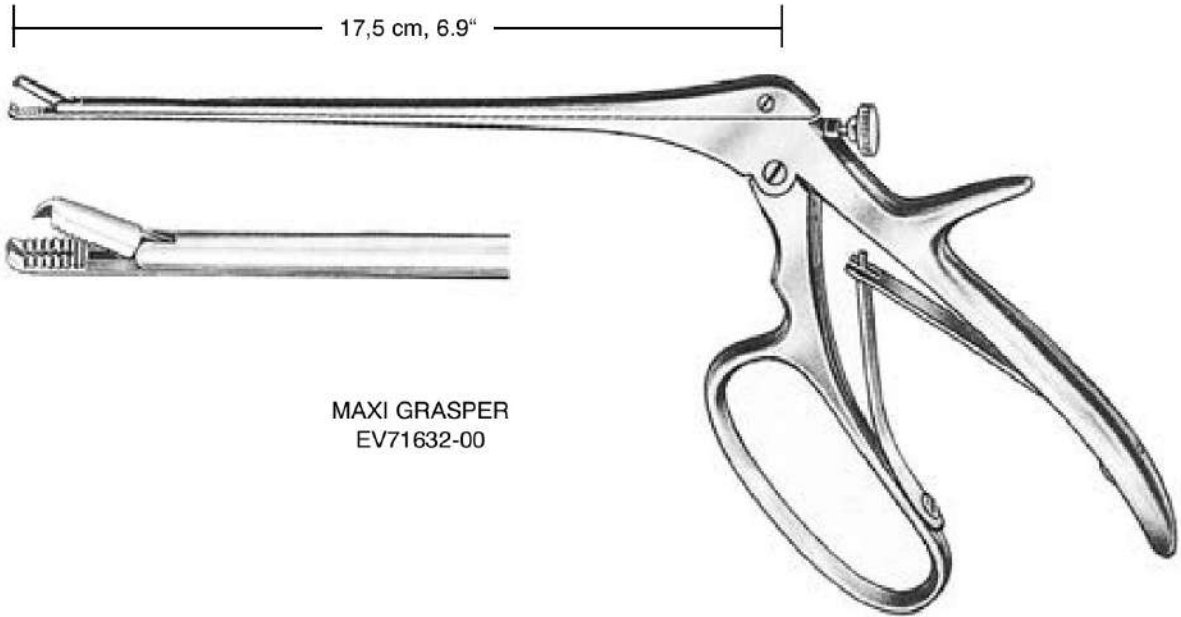
komplett  
 compl. instr.  
 Instrum. compl.

Aufsatz allein  
 Tip only  
 Punta sola

Uterus Biopsiezangen  
 Biopsy Specimen Forceps  
 Pinzas sacabocado p. biopsia  
 Pinze per biopsia



Uterus Biopsiezangen  
Biopsy Specimen Forceps  
Pinzas sacabocado p. biopsia  
Pinze per biopsia



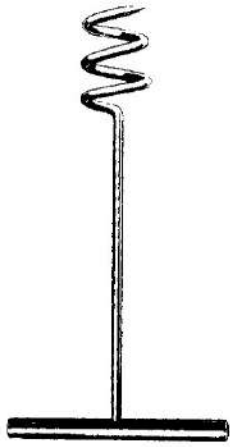


Myomheber, Myommesser, Fistelhäkchen, Meßinstrumente, Uteruslöffel

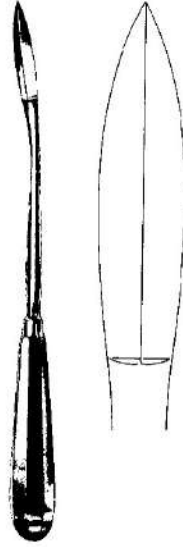
Myoma Screw, Myoma Knife, Fistula Hook, Measuring Instruments, Uterine Curettes

Tirabuzón para fibromas, Bisturi para fibromas, Ganchos para fistulas, Instrumental para medir, Curetas uterinas

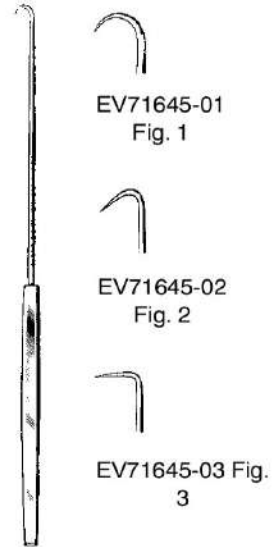
Tiramiomi, Bisturi per fibromi, Uncini per fistole, Strumenti per misure, Curette uterine



DOYEN  
EV71641-17  
17 cm, 6 3/4"



SEGOND  
EV71643-27  
27 cm, 10 1/2"

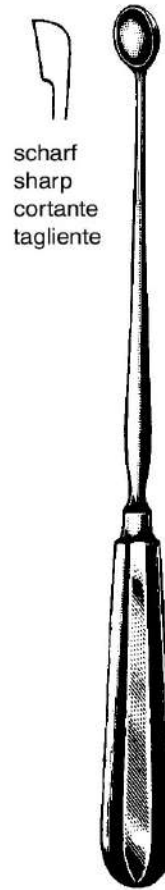


EMMET  
EV71645-01 - EV71645-03  
22 cm, 8 3/4"



EV71646-01

EV71646-02



scharf  
sharp  
cortante  
tagliente

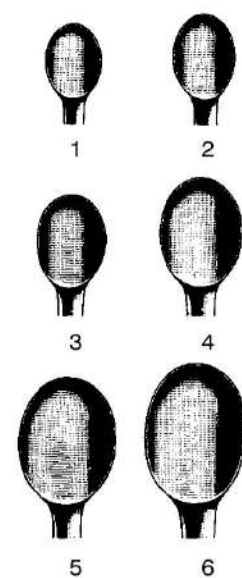
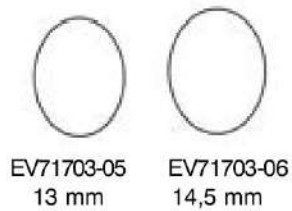
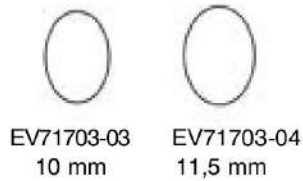
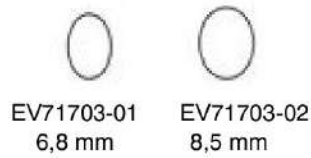


Fig. SIMON  
1 EV71702-01 6,8 mm  
2 EV71702-02 8,5 mm  
3 EV71702-03 10,0 mm  
4 EV71702-04 11,5 mm  
5 EV71702-05 13,0 mm  
6 EV71702-06 14,5 mm  
25 cm, 10"

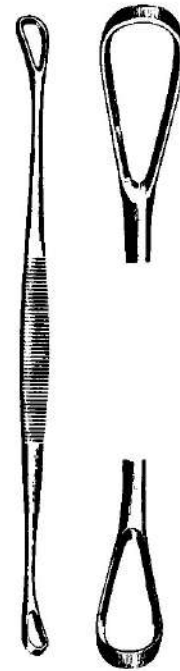
Uterus-Küretten  
 Uterine Curettes  
 Curetas uterinas  
 Curette uterine



SCHRÖDER  
 31 cm, 12 1/4"



scharf/stumpf  
 sharp/blunt  
 cortante/roma  
 tagliente/smussa



BLAKE  
 EV71704-27  
 27 cm, 10 1/2"

Salpingograph  
Salpingograph  
Salpingógrafo  
Salpingografo

**71650-00**

SCHULTZE Salpingograph bestehend aus:

- EV71650-01 1 Tubenkatheter EV71650-02
- 1 Zwischenstück EV71650-03
- 1 Manometer EV71650-04
- 1 Kegel, klein EV71650-05
- 1 Kegel, mittel EV71650-06
- 1 Kegel, groß EV71650-07
- 1 Recordspritze mit Luer-Lock Ansatz 10cc

SCHULTZE salpinogograph compl.:

- EV71650-01 1 Tubal catheter only EV71650-02
- 1 connecting piece EV71650-03
- 1 manometer EV71650-04
- 1 cone small EV71650-05
- 1 cone medium EV71650-06
- 1 cone large EV71650-07
- 1 syringe record with Luer-Lock 10cc

Salpingógrafo compuesto de:

- EV71650-01 1 cateter de tubo
- EV71650-02 1 pieza de conexion
- EV71650-03 1 manometro
- EV71650-04 1 cono pequeño
- EV71650-05 1 cono mediano
- EV71650-06 1 cono grande
- EV71650-07 1 jeringa con conexión Luer-Lock 10cc

Salpingografo composto da:

- EV71650-01 1 Catetere per tubo
- EV71650-02 1 Raccordo
- EV71650-03 1 Manometro
- EV71650-04 1 Cono, piccolo
- EV71650-05 1 Cono, medio
- EV71650-06 1 Cono, grande
- EV71650-07 1 Siringa record con raccordo Luer-Lock 10cc

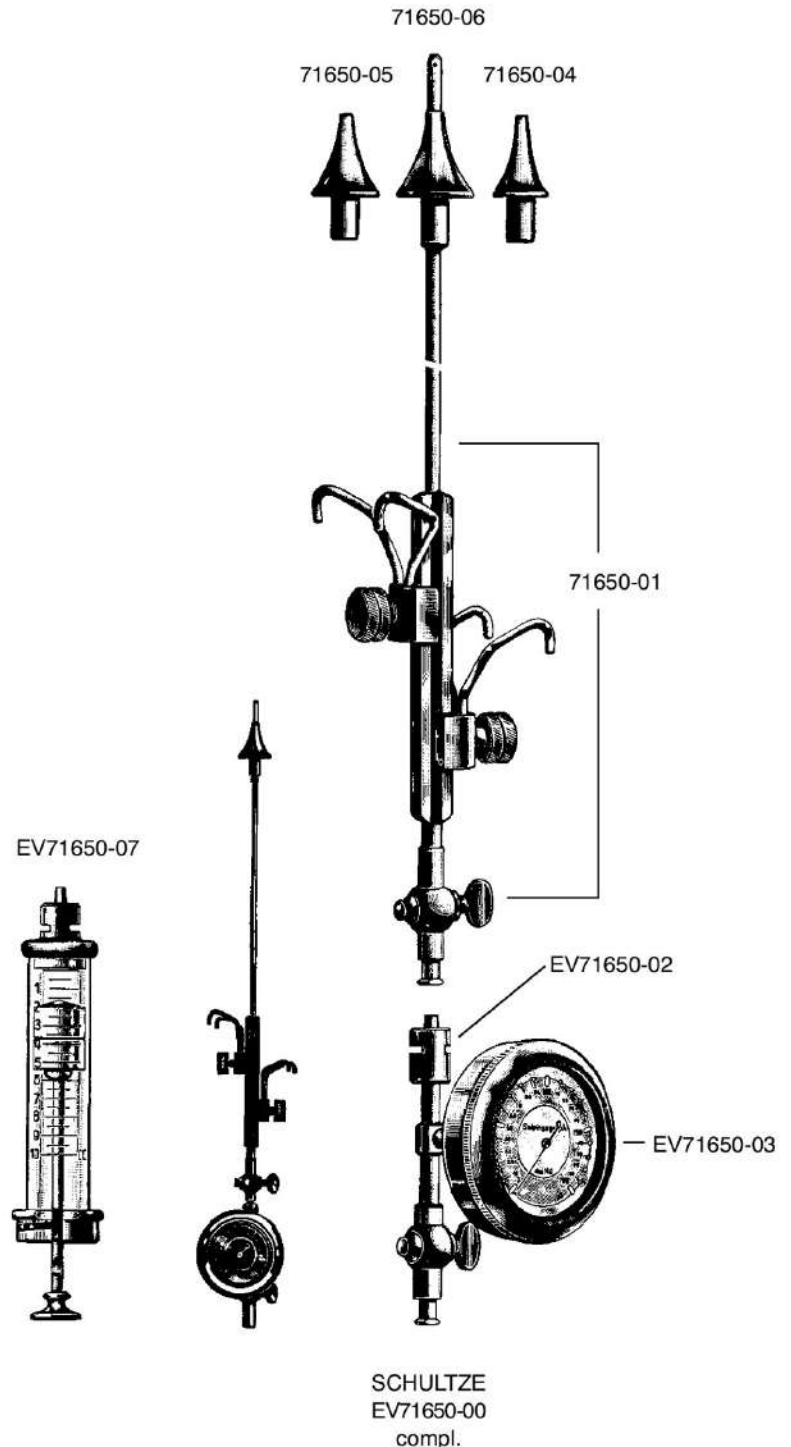
**EV71660-00**

Schultze Salpingograph, jedoch ohne Manometer

Schultze Salpingograph without manometer

Schultze Salpingografo sin manometro

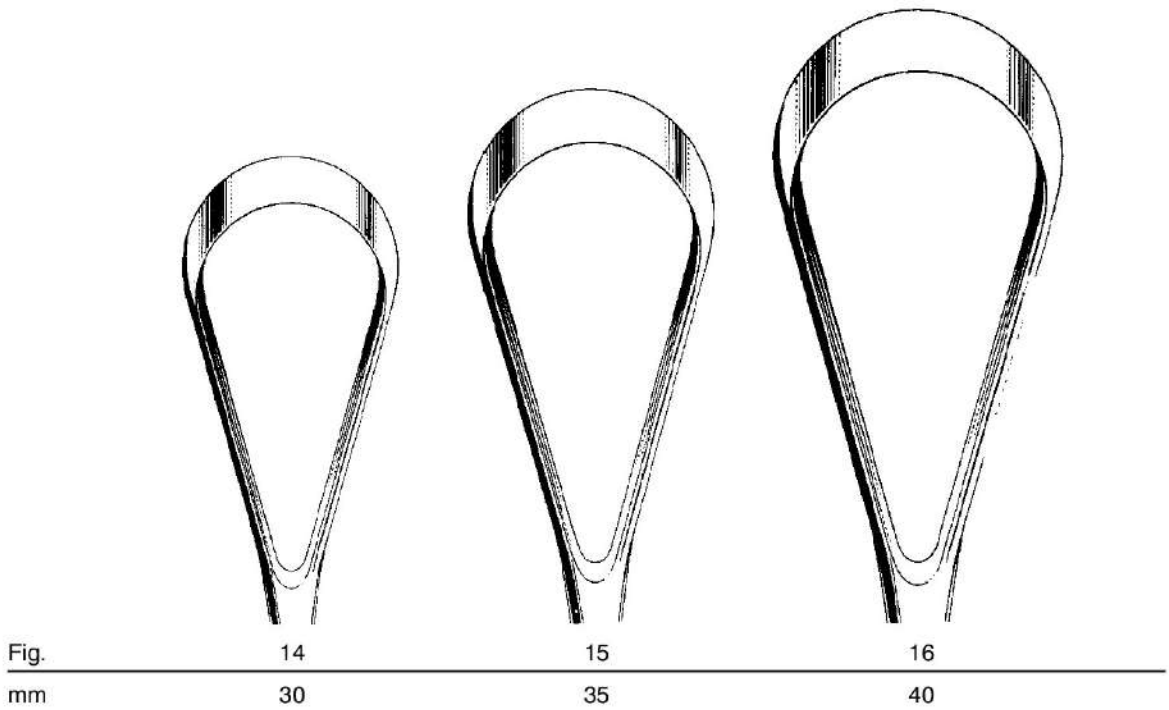
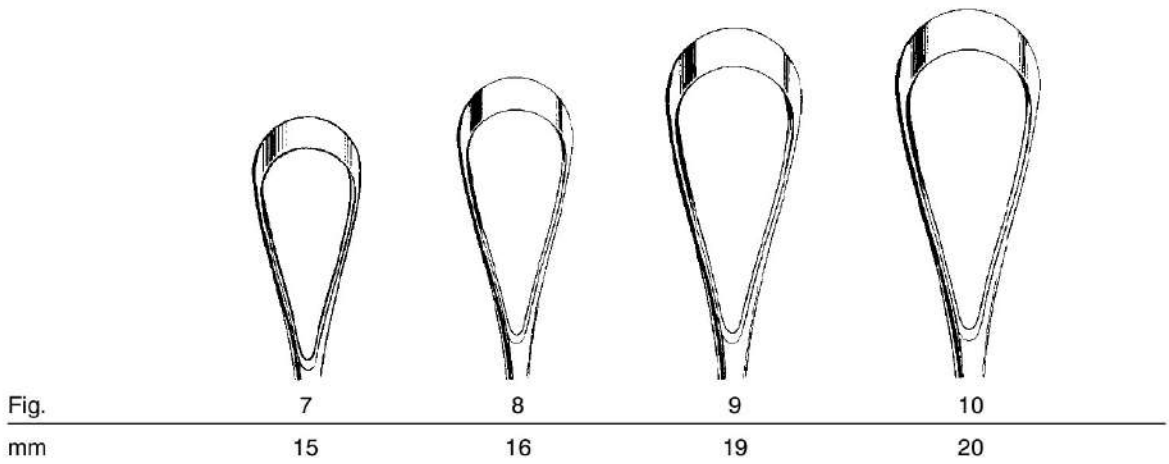
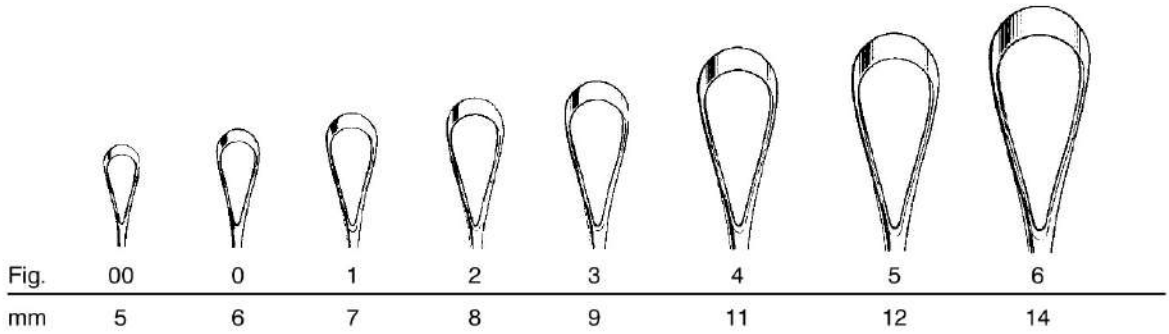
Schultze Salpingografo senza manometro



im Etui  
in case  
en estuche  
in astuccio



Uterus-Küretten  
 Uterine Curettes  
 Curetas uterinas  
 Curette uterine



SIMS RECAMIER BUMM  
 EV71710-05 - EV71735-28

Uterus-Küretten  
 Uterine Curettes  
 Curetas uterinas  
 Curette uterine



THOMAS  
 28 cm, 11"

stumpf  
 blunt  
 roma  
 smussa

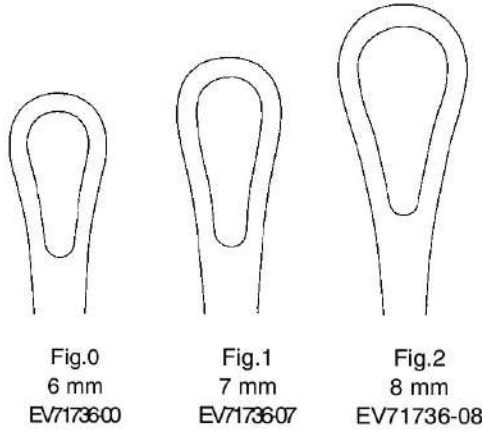


Fig.0  
 6 mm  
 EV71736-00

Fig.1  
 7 mm  
 EV71736-07

Fig.2  
 8 mm  
 EV71736-08

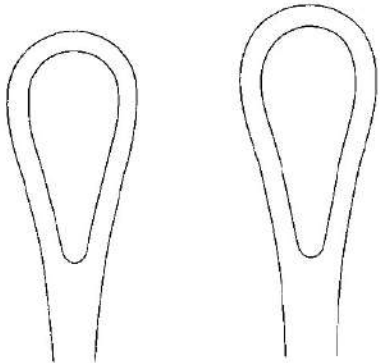


Fig.3  
 9 mm  
 EV71736-09

Fig. 4  
 10 mm  
 EV71736-10

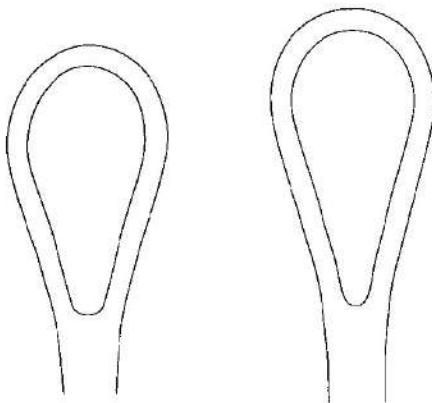


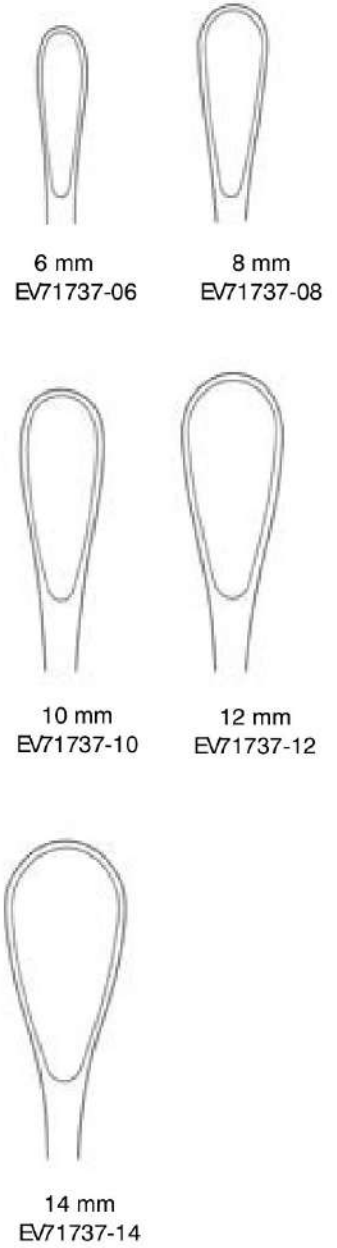
Fig. 5  
 11 mm  
 EV71736-11

Fig. 6  
 12 mm  
 EV71736-12



GOURDET  
 28 cm, 11"

stumpf  
 blunt  
 roma  
 smussa



6 mm  
 EV71737-06

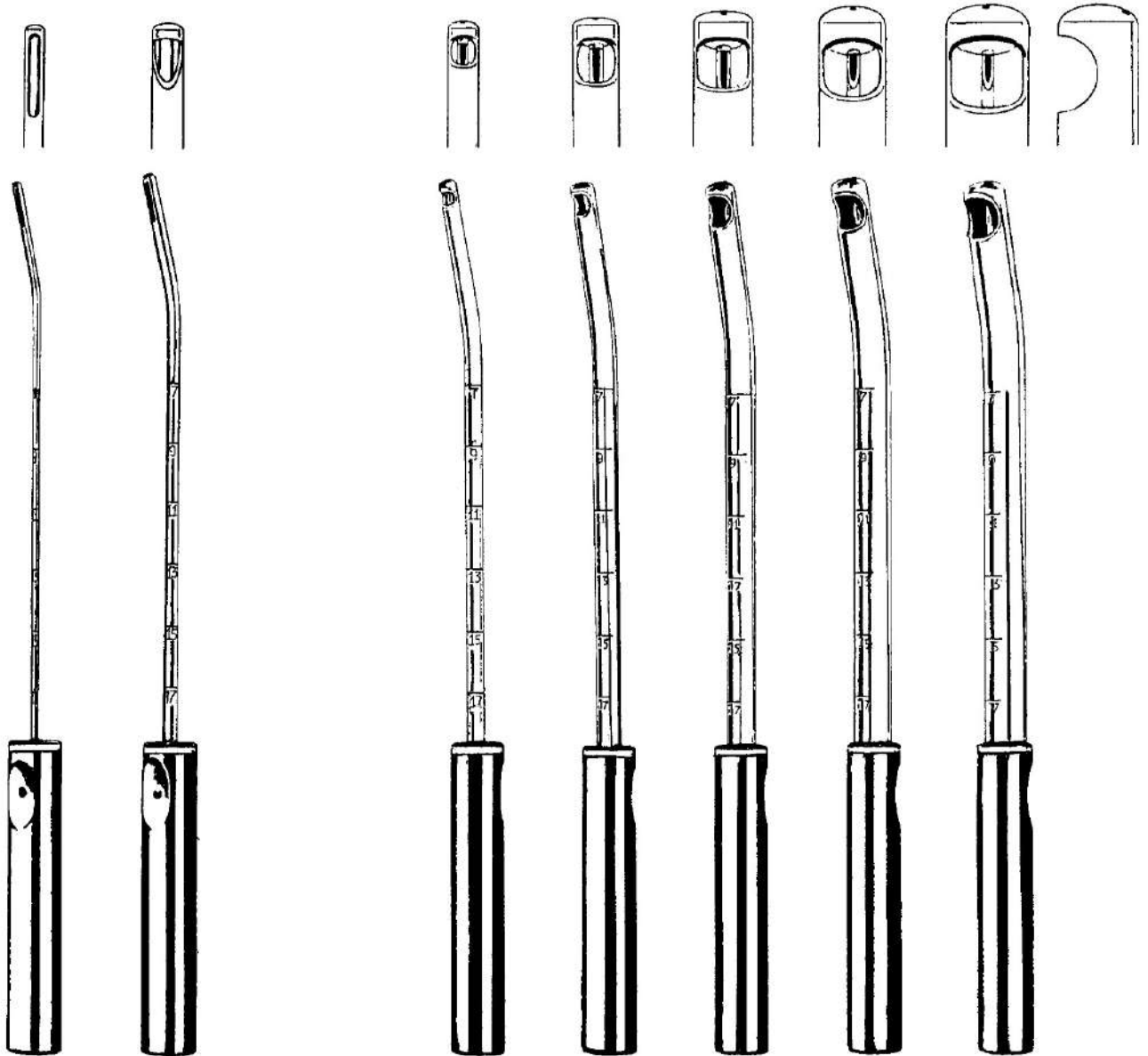
8 mm  
 EV71737-08

10 mm  
 EV71737-10

12 mm  
 EV71737-12

14 mm  
 EV71737-14

Biopsie- und Absaugküretten, Schlauch-Verbindungsstück  
 Specimen and Aspirating Curettes, Hose connecting piece  
 Curetas para biopsia y aspiración, Pieza conexión para tubos  
 Curette di aspirazione per biopsia, Raccordo di connessione per tubi



EV71803-03 3 mm Ø  
 EV71803-04 4,5 mm Ø

EV71803-06 6 mm Ø  
 EV71803-08 8 mm Ø  
 EV71803-10 10 mm Ø  
 EV71803-12 12 mm Ø  
 EV71803-14 14 mm Ø



EV71803-15

Amnioskope  
Amnioscope  
Amnioscopio  
Amnioscopio



EV71810-12 12 x 24 mm Ø 20 cm, 8"  
EV71810-16 16 x 24 mm Ø 20 cm, 8"  
EV71810-20 20 x 24 mm Ø 20 cm, 8"

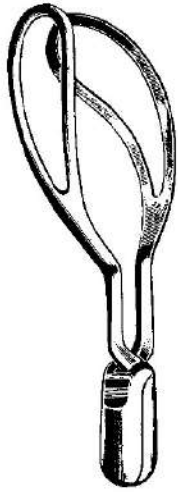


EV71810-50  
Kaltlichtklammer Cold  
Light clamp Adaptador  
de iluminacion  
Adattore di illuminazione





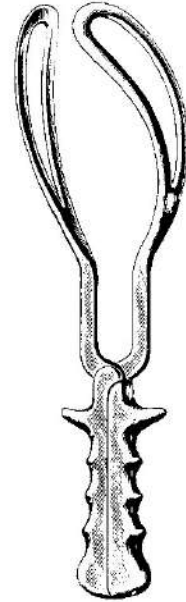
Geburtszangen  
 Obstetrical Forceps  
 Forceps obstétricos  
 Forcipi



WRIGLEY  
 EV73101-23  
 23 cm, 9"



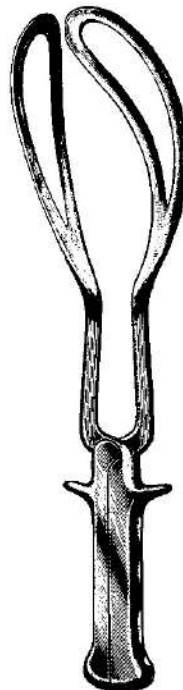
SIMPSON  
 EV73102-30  
 30 cm, 11 3/4"



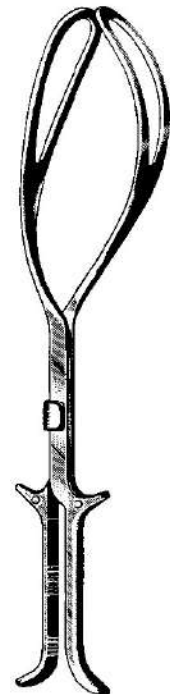
SIMPSON-BRAUN  
 EV73105-33 33 cm, 13"  
 EV73105-36 36 cm, 14"



De LEE  
 EV73107-30  
 30 cm, 11 3/4"



De LEE  
 EV73108-36 36 cm, 14"  
 EV73108-39 39 cm, 15 1/2"

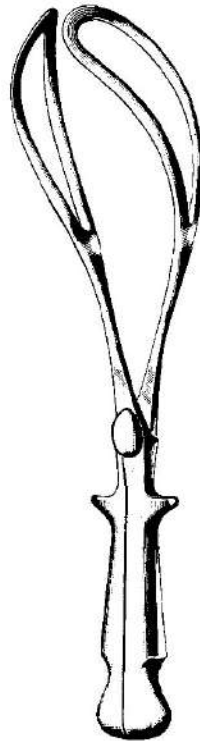


KIELLAND  
 EV73110-41  
 41 cm, 16"

Geburtszangen  
Obstetrical Forceps  
Forceps obstétricos  
Forcipi



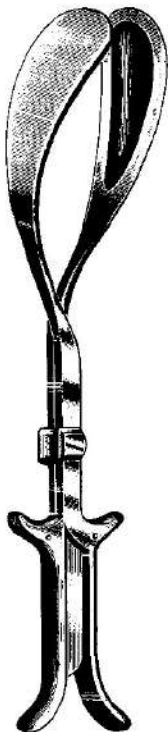
ELLIOT  
EV73115-32 32 cm, 12 <sup>3</sup>/<sub>4</sub>"  
EV73115-38 38 cm, 15"



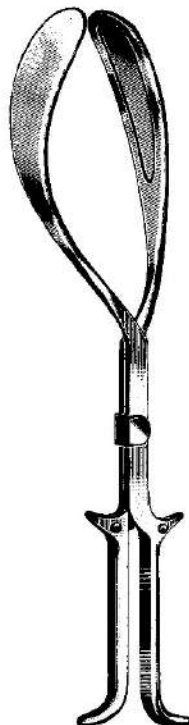
NAEGELE  
EV73119-36 36 cm, 14"  
EV73119-40 40 cm, 15 <sup>3</sup>/<sub>4</sub>"



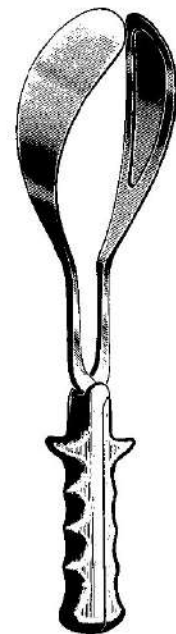
THIERRY  
EV73123-39 39 cm, 15 <sup>1</sup>/<sub>2</sub>"



LUIKART  
EV73125-40  
40 cm, 15 <sup>3</sup>/<sub>4</sub>"

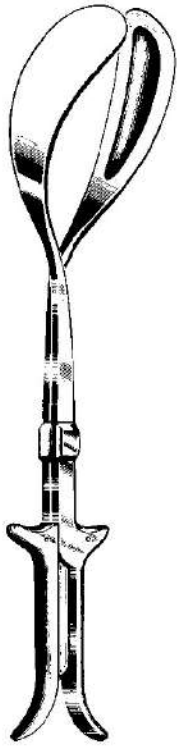


KIELLAND-LUIKART  
EV73127-40  
40 cm, 15 <sup>3</sup>/<sub>4</sub>"



SIMPSON-LUIKART  
EV73135-36  
36 cm, 14"

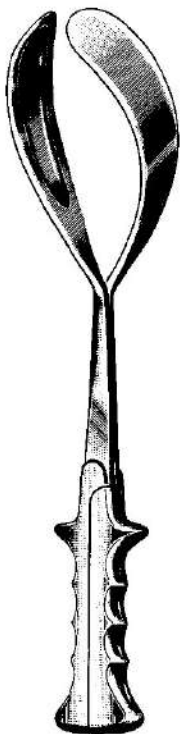




McLEAN-TUCKER-LUIKART  
EV73139-40  
40 cm, 15 3/4"



McLEAN-TUCKER  
EV73141-39  
39 cm, 15 1/2"

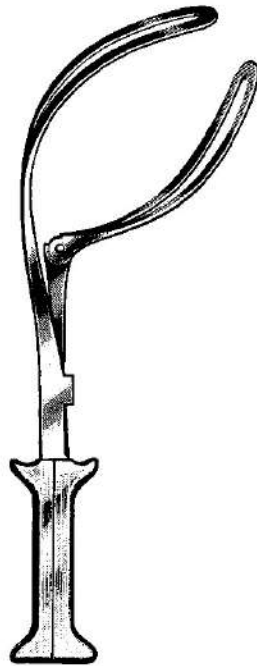


McLEAN-LUIKART  
EV73143-39  
39 cm, 15 1/2"



McLEAN  
EV73145-36  
36 cm, 14"

Geburtszangen, Zughebel  
Obstetrical Forceps, Traction Handle  
Forceps obstétricos, Dispositivos de tracción  
Forcipi, Leve per trazione



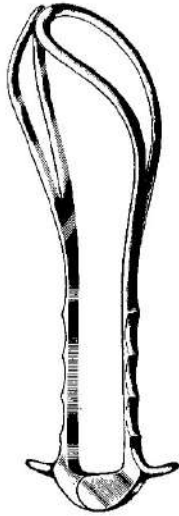
BARTON  
EV73147-36  
36 cm, 14"



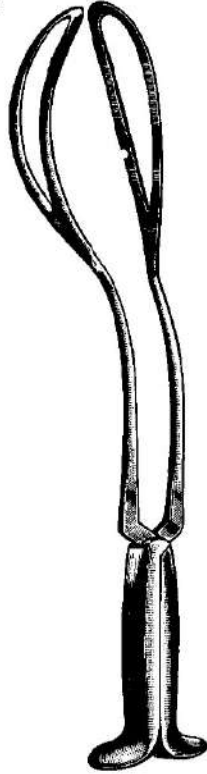
BARTON  
EV73148-17  
17 cm, 6 3/4"



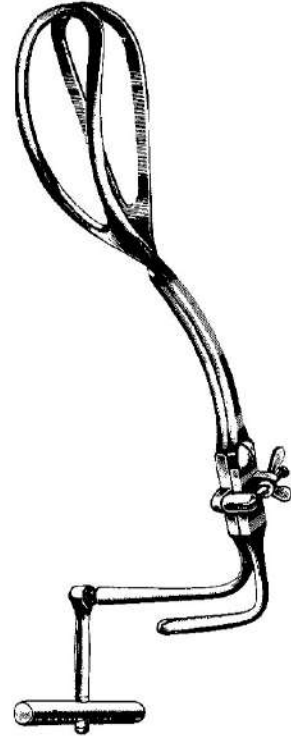
Geburtszangen, Zughebel  
 Obstetrical Forceps, Traction handles  
 Forceps obstétricos, Dispositivos de tracción  
 Forcipi, Leve per trazione



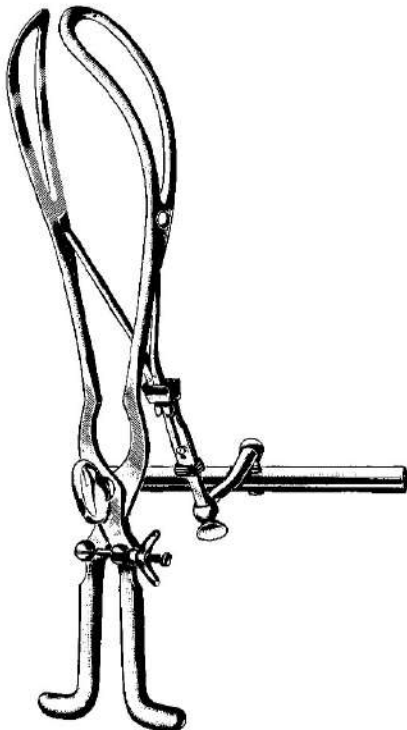
BOERMA  
 EV73151-29  
 29 cm, 11 1/2"



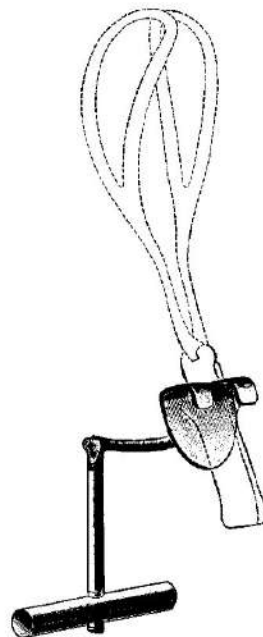
PIPER  
 EV73155-44  
 44 cm, 17 1/4"



PIPER  
 EV73157-40  
 40 cm, 15 3/4"



TARNIER  
 EV73162-40  
 40 cm, 15 3/4"



BILL  
 EV73170-00  
 21 cm, 8 1/4"

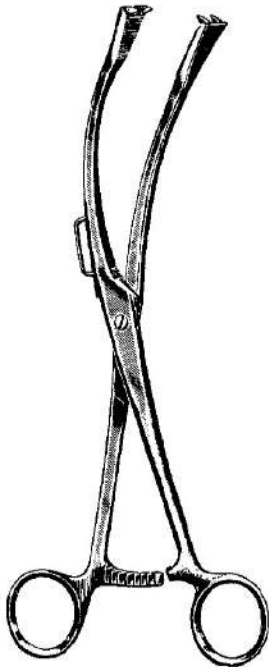


LUIKART-BILL  
 EV73171-21  
 21 cm, 8 1/4"

Geburtshaken, Kopfschwartzangen, Uterus-Klemmzange, Nabelschnurklemmen, Beckenzirkel  
 Scalp flap forceps, Uterine haemostatic forceps, Umbilical cord clamps, Pelvimeters  
 Pinzas para cuero cabelludo, Pinzas-clamps uterinas para hemóstasis, Clamp umbilical, Pelvímetros  
 Pinza per il cuoio capelluto, Pinza uterina, Pinza ombelicale, Pelvimetri



**SMELLIE**  
 EV73181-33  
 33 cm, 13"



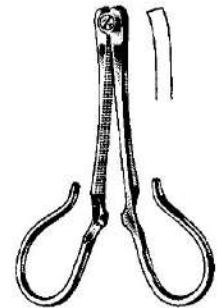
**GAUSS**  
 EV73183-27  
 27 cm, 10 1/2"



**GREEN-ARMYTAGE**  
 EV73184-21  
 21 cm, 8 1/4"



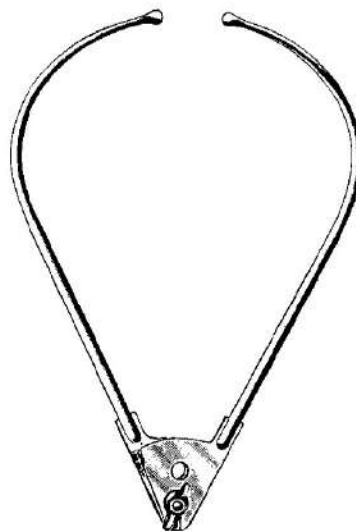
**COLLIN**  
 EV73187-09  
 9 cm, 3 1/2"



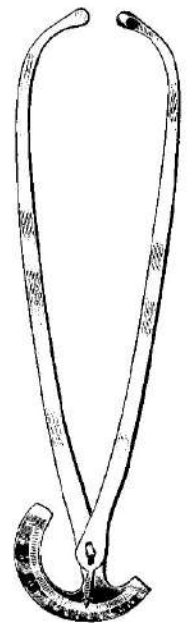
**KANE**  
 EV73189-09  
 8,5 cm, 3 1/4"



**MARTIN**  
 EV73191-34  
 34 cm, 13 1/2"

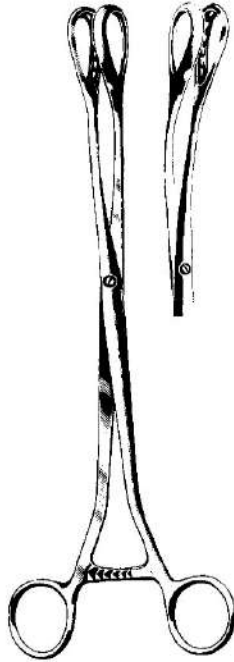


**COLLIER**  
 EV73193-30  
 30 cm, 11 3/4"

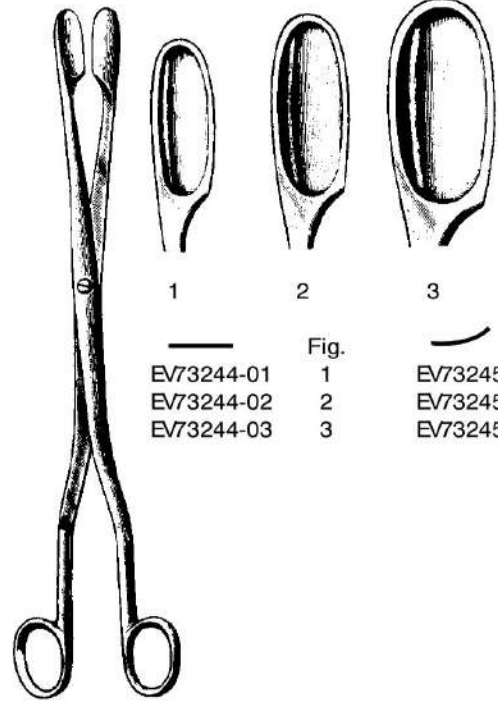


**COLLIN**  
 EV73195-35  
 35 cm, 14"

Abortuszangen, Abortuslöffel  
 Ovum Forceps, Abortion Scoops  
 Pinzas para aborto, Cucharillas para aborto  
 Ostetricia, Curette per aborto

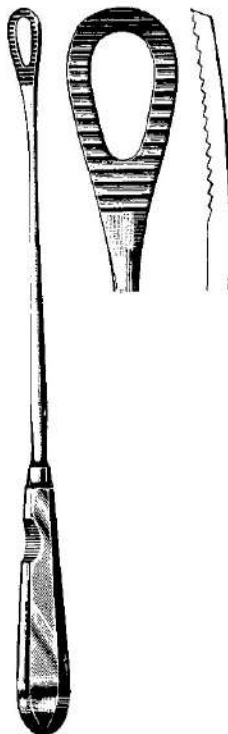


SAENGER  
 EV73242-27 EV73243-27  
 27 cm, 10 1/2"

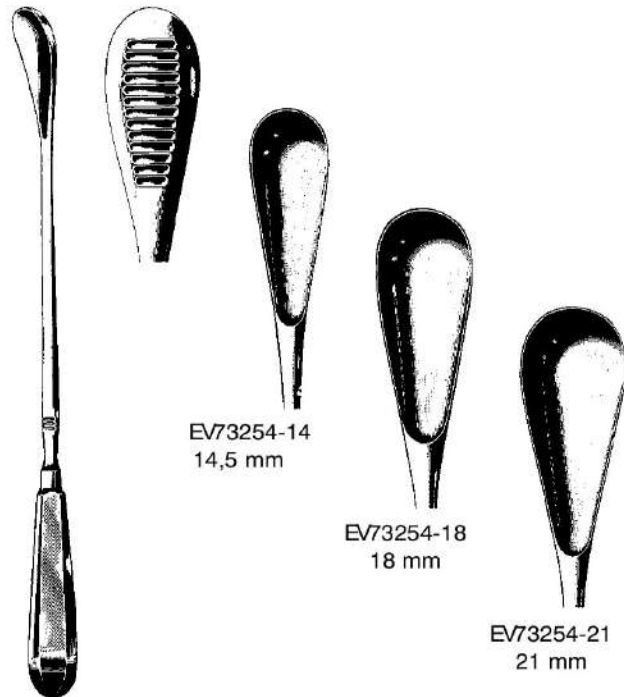


WINTER  
 EV73244-01 -  
 EV73245-03  
 28 cm, 11"

|      |            |            |            |
|------|------------|------------|------------|
|      | 1          | 2          | 3          |
| Fig. | 1          | 2          | 3          |
|      | EV73244-01 | EV73245-01 | EV73245-03 |
|      | EV73244-02 | EV73245-02 |            |
|      | EV73244-03 |            |            |



PESTALOZZA  
 EV73252-30  
 30 cm, 11 3/4"



CUZZI  
 EV73254-14 - 73254-21  
 30 cm, 11 3/4"

EV73254-14  
 14,5 mm

EV73254-18  
 18 mm

EV73254-21  
 21 mm

Abortuslöffel, Geburtslöffel, Kranioklast, Basiotrip, Perforatorium, Dekapitationshaken  
 Abortion Scoops, Elevating Spoon, Cranioclast, Basiotribe, Perforators, Decapitating hook  
 Cucharillas para aborto, Separador obstetrico, Craneoclasto, Basiotribo, Perforacráneos, Gancho para decapitación  
 Curette per aborto, Cucchiaio Ostetrico, cranioclasto, Basiotribo, spezzacrani, Uncino per decapitazione



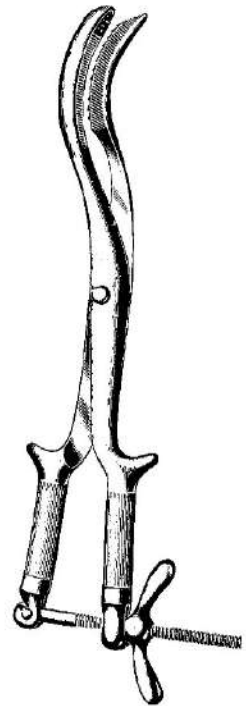
stumpf  
blunt  
roma  
smussa



WALLICH  
EV73256-42  
42 cm, 16 1/2"



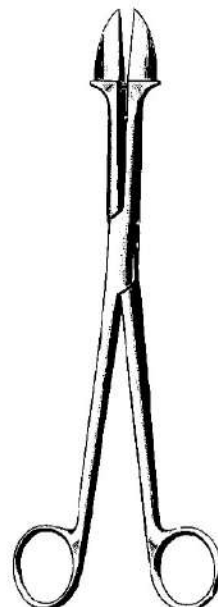
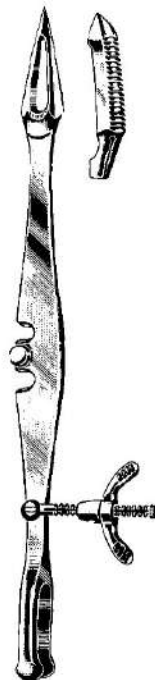
SELLHEIM  
EV73259-28  
28 cm, 11"



BRAUN  
EV73302-42  
42 cm, 16 1/2"



TARNIER  
EV73304-46  
46 cm, 18"



SMELLIE  
EV73306-25  
25 cm, 10"



BRAUN  
EV73309-30  
30 cm, 11 3/4"



Hauthäkchen, Komedonenquetscher, Lupusküretten, Hautküretten, Haut-Trephinen  
 Skin hooks, Comedone extractors, Lupus curettes, Skin curettes, Cutaneous punches  
 Ganchos cutáneos, Saca comedones, Curetas para lupus, Curetas cutáneas, Trépanos cutáneos  
 Uncini cutanei, Schiaccia comedoni, Curette per lupus, Curette cutanee, Trefine cutanee



**KILNER**  
 EV75103-15  
 15 cm, 6"



**SCHAMBERG**  
 EV75111-10  
 10 cm, 4"



**UNNA**  
 EV75113-14  
 14 cm, 5 1/2"



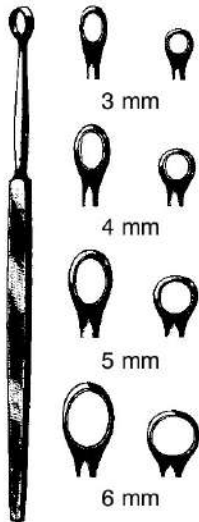
**UNNA**  
 EV75115-14  
 14 cm, 5 1/2"



**WALTON**  
 EV75118-14  
 14 cm, 5 1/2"



**SAALFELD**  
 EV75121-10  
 10 cm, 4"

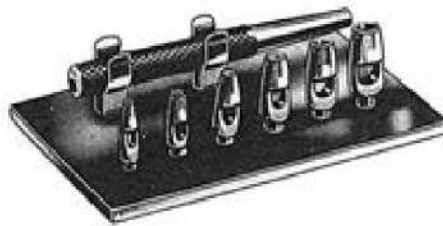


14 cm, 5 1/2"

|                 |                 |
|-----------------|-----------------|
| <b>FOX</b>      | <b>FOX</b>      |
| EV75128-01 1 mm | EV75129-01 1 mm |
| EV75128-02 2 mm | EV75129-02 2 mm |
| EV75128-03 3 mm | EV75129-03 3 mm |
| EV75128-04 4 mm | EV75129-04 4 mm |
| EV75128-05 5 mm | EV75129-05 5 mm |
| EV75128-06 6 mm | EV75129-06 6 mm |



**PIFFARD**  
 14,5 cm, 5 3/4"  
 EV75130-01 Fig. 1  
 EV75130-02 Fig. 2  
 EV75130-03 Fig. 3



**75138-00**  
 Satz komplett mit 6 Aufsätzen  
 Set complete with 6 tips  
 Juego con 6 puntas  
 Serie completa con 6 trefini



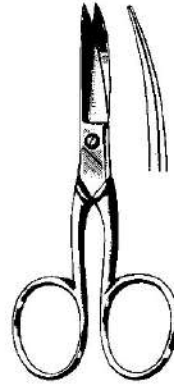
|  |      |
|--|------|
|  | 2 mm |
|  | 3 mm |
|  | 4 mm |
|  | 5 mm |
|  | 6 mm |
|  | 7 mm |
|  | 8 mm |

**KEYES**  
 10 cm, 4"  
 EV75140-02 2 mm  
 EV75140-03 3 mm  
 EV75140-04 4 mm  
 EV75140-05 5 mm  
 EV75140-06 6 mm  
 EV75140-07 7 mm  
 EV75140-08 8 mm

Nagelzangen, -Scheren  
Nail Nippers, Scissors  
Alicates corta-uñas  
Tronchesini forbici per unghie



EV75301-10



EV75304-10 10 cm, 4" EV75305-10



EV75331-14  
14 cm, 5 1/2"  
stainless

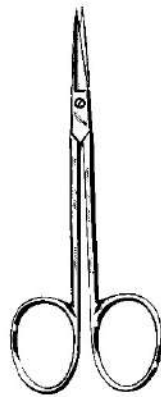


TURNBULL  
EV75341-11 11,5 cm, 4 1/2"  
EV75341-13 13,5 cm, 5 1/4"  
stainless

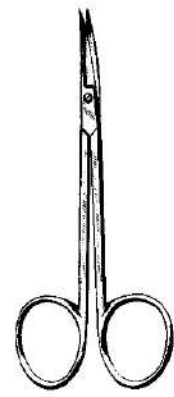
Nagelhautzangen, Hautscheren, Nagelfeilen  
Cuticle Nippers, Cuticle Scissors, Nail Files  
Pinzas y Tijeras cuticulares, Limas para uñas  
Tronchesine per unghie e pelle, Limette per le unghie



EV75373-10  
10,5 cm, 4"



EV75378-10  
10 cm, 4"

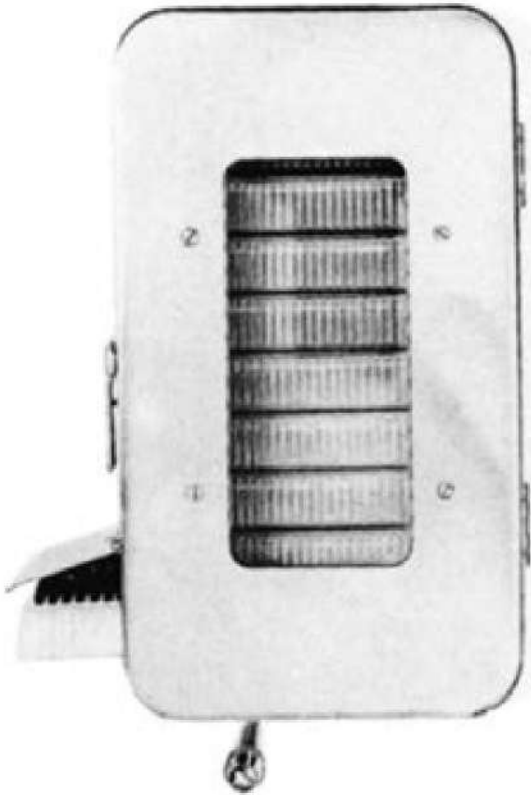


EV75379-10  
10 cm, 4"



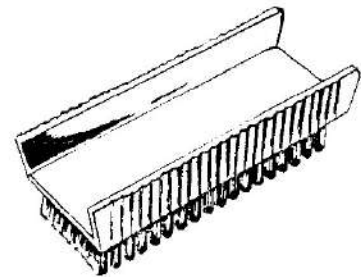
EV75382-16

Bürstenspender, Handwaschbürsten  
Brush Dispensor, Nail brushes  
Dispensador de cepillos, Cepillo para uñas  
Distributore di spazzole, Spazzole per unghie



EV75396-01  
Bürstenspender für 10 Bürsten  
Brush dispensor for 10 brushes Dis-  
tribuidor de cepillos para 10 cepillos  
Distributore per spazzolini da 10

EV75396-02  
Bürstenspender für 20 Bürsten  
Brush dispensor for 20 brushes Dis-  
tribuidor de cepillos para 20 cepillos  
Distributore per spazzolini da 20



EV75397-00

Pack. à 10 St.  
Box of 10 pcs  
caja de 10 pzas.  
confezione da 10 pezzi

Hygiene  
Hygiene  
Higiene  
Igiene



PROBE AND PACKER  
EV75450-00  
14,5 cm, 5 3/4"



SPATULA AND PACKER  
EV75440-00  
14,5 cm, 5 3/4"



mit Loch, with hole, con  
agujero, con foro

EV75430-12 = 1,5 mm + 2 mm  
EV75430-13 = 1,5 mm + 2,5 mm  
14,5 cm, 5 3/4"

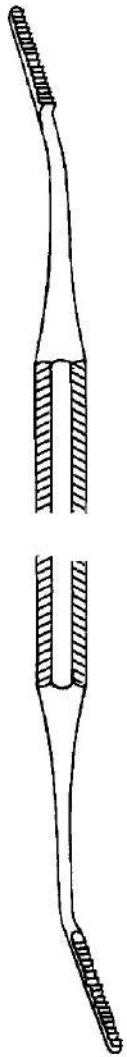


14,5 cm, 5 3/4" ohne  
Loch, without hole, sin agu-  
jero, senza foro

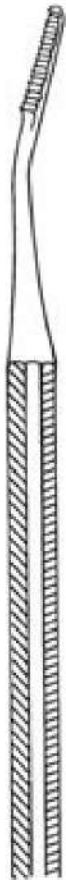
EV75400-01 = 1 mm  
EV75400-02 = 1,5 mm  
EV75400-03 = 2 mm  
EV75400-04 = 2,5 mm

mit Loch, with hole, con  
agujero, con foro

EV75410-01 = 1 mm  
EV75410-02 = 1,5 mm  
EV75410-03 = 2 mm  
EV75410-04 = 2,5 mm



75410-15  
17,5 cm, 6<sup>3</sup>/<sub>4</sub>"



75420-15  
15 cm, 6"



75430-01  
12,5 cm, 5"



75440-11  
11,5 cm, 4<sup>1</sup>/<sub>2</sub>"



INGROWN  
75445-12  
12,5 cm, 5"

Nagelzangen  
Nail Nippers  
Alicates corta-uñas  
Tronchesini per unghie

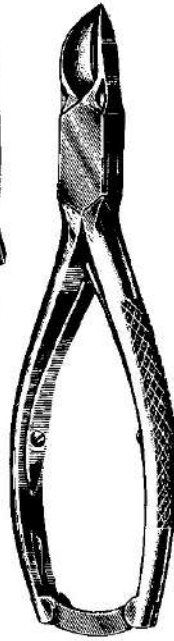
stainless steel



EV75450-13  
concave



EV75460-13  
gerade  
straight recto  
retta



14,5 cm, 5 3/4"

stainless steel



EV75470-11  
10 cm  
4"



EV75475-11  
11,5 cm  
4 1/2"



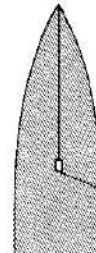
EV75480-13  
12,5 cm  
5"



fine  
EV75485-13  
12,5 cm  
5"



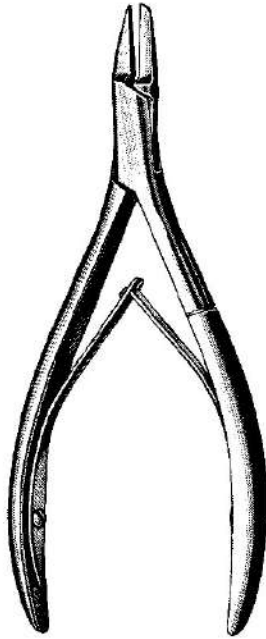
EV75490-15  
15 cm  
6"



fine  
EV75500-15  
15 cm  
6"

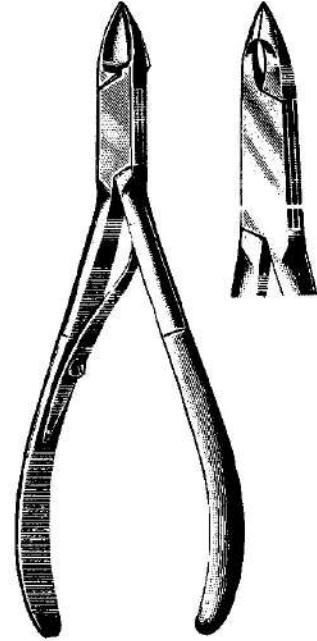
Nagelzangen  
Nail Nippers  
Alicates corta-uñas  
Tronchesini per unghie

stainless steel



ANVIL  
EV75550-13  
13 cm, 5 1/8"

stainless steel

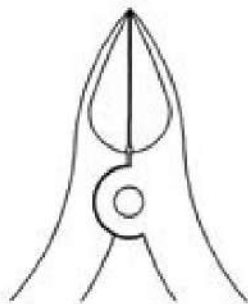


EV75600-10  
10 cm, 4"

stainless steel



EV75618-15  
15,2 cm, 6"



gerade  
straight

stainless steel



EV75620-15  
15,5 cm, 6"



concave



Nagelzangen, Nagelspaltscheren  
Nail Nippers, Nail splitting scissors  
Alicates corta-uñas, Tijeras para hender uñas  
Tronchesini per unghie, Forbici per staccare unghie

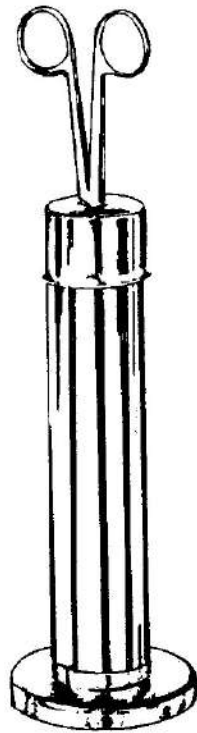


EV75630-12  
12 cm, 4<sup>3</sup>/<sub>4</sub>"



EV75640-15  
15 cm, 6"

Kappenzangen, Nadel-Sterilisierkästen  
 Sterilizing Forceps, Needle Sterilizing cases  
 Combinacion tapa-pinza, Estuches para esterilizar agujas  
 Pinza coperchio, Scatole per sterilizzare aghi



EV89111-25 25 cm, 10"  
 EV89111-32 32 cm, 12<sup>3</sup>/<sub>4</sub>"



EV89112-65  
 65 x 15 mm



EV89113-65



EV89114-00  
 150 x 95 x 13 mm



EV89115-50 50 x 25 x 4,5 mm  
 EV89115-65 65 x 42 x 8,0 mm  
 EV89115-75 75 x 25 x 4,5 mm

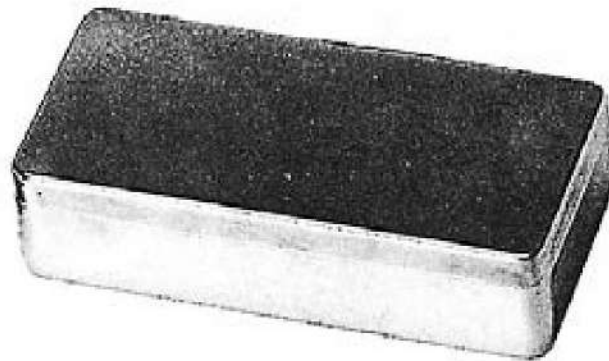


EV89116-50 50 x 25 x 4,5 mm  
 EV89116-65 65 x 42 x 8,0 mm  
 EV89116-75 75 x 25 x 4,5 mm



Abmessungen in mm  
Sizes in mm  
tamaños en mm  
misura in mm

|              |            |
|--------------|------------|
| l x b x h mm |            |
| 400x200x80   | EV89121-40 |
| 500x270x70   | EV89121-50 |



|                   |                         |
|-------------------|-------------------------|
| Abmessungen in mm | Deckel ohne Knopf       |
| Sizes in mm       | lid without knob        |
| tamaños en mm     | tapa sin botón          |
| misura in mm      | coperchio senza bottone |

|              |            |
|--------------|------------|
| l x b x h mm |            |
| 165x 85x35   | EV89122-16 |
| 200x100x50   | EV89122-21 |
| 260x150x50   | EV89122-26 |
| 300x200x50   | EV89122-30 |

Bereitschaftskästen  
 Storage cases  
 Cajas para almacenaje  
 Scatole per magazzino



Abmessungen in mm (l x b x h)  
 Sizes in mm (l x b x h)  
 tamaños en mm (l x f x a)  
 misura in mm (l x l x a)

230 x 130 x 50  
 260 x 150 x 50  
 275 x 235 x 50  
 300 x 200 x 50  
 325 x 275 x 50  
 420 x 175 x 50

230 x 130 x 75  
 260 x 150 x 75  
 300 x 200 x 75  
 325 x 275 x 75  
 420 x 175 x 75

Behälter  
 Containers  
 Recipientes Re-  
 cipienti

EV89124-23  
 EV89124-26  
 EV89124-27  
 EV89124-30  
 EV89124-32  
 EV89124-42

EV89125-23  
 EV89125-26  
 EV89125-30  
 EV89125-32  
 EV89125-42

Satz Spezialfilter (5 Paar)  
 Set of spezial filters (5 pairs)  
 Juego de filtros especiales (5 pares) Set  
 die 5 paia di filtri speciali

EV89126-23  
 EV89126-26  
 EV89126-27  
 EV89126-30  
 EV89126-32  
 EV89126-42

EV89127-23  
 EV89127-26  
 EV89127-30  
 EV89127-32  
 EV89127-42

18/10  
Stainless Steel  
Acero inoxidable  
Acciajo inossidabile

matt  
satin finish  
pulidas mate  
opaco



| Abmessungen in mm<br>sizes in mm<br>Tamaños en mm<br>misura in mm<br>Ø x h | Inhalt<br>capacity<br>capacidad<br>capacità<br>l |            |
|--|--|------------|
| 40x19  | 0,05   | EV89127-04 |
| 61x30  | 0,07   | EV89127-06 |
| 80x40  | 0,14   | EV89127-08 |
| 116x50   | 0,35   | EV89127-11 |
| 128x55   | 0,45   | EV89127-12 |
| 147x65   | 0,70   | EV89127-14 |
| 167x75   | 1,10   | EV89127-16 |
| 187x85   | 1,60   | EV89127-18 |

| Abmessungen in mm<br>sizes in mm<br>Tamaños en mm<br>misura in mm<br>Ø x h | Inhalt<br>capacity<br>capacidad<br>capacità<br>l |            |
|--|--|------------|
| 100x30   | 0,15   | EV89129-11 |



|            | mm x mm   | l     |
|------------|-----------|-------|
| EV89133-16 | 165 x 60  | 0,75  |
| EV89133-17 | 175 x 70  | 1,00  |
| EV89133-22 | 220 x 80  | 2,00  |
| EV89133-24 | 240 x 110 | 3,00  |
| EV89133-31 | 310 x 120 | 6,00  |
| EV89133-34 | 345 x 125 | 8,50  |
| EV89133-38 | 380 x 130 | 11,00 |

|            |                   |        |
|------------|-------------------|--------|
| EV89139-17 | 170 x 100 x 35 mm | 0,50 l |
| EV89139-25 | 250 x 140 x 40 mm | 1,25 l |
| EV89139-27 | 275 x 150 x 45 mm | 2,25 l |

Meßbecher, Dose, Standgefäß, Mehrzweckschalen  
 Graduated Measures, Box, Jars, Universal Trays  
 Copas graduadas, Recipientes, Tarros, Bandejas para instrumentos  
 Bicchieri graduati, Recipienti, Recipienti cilindrici, Bacinelle per strumenti

18/10  
 Stainless Steel  
 Acero inoxidable  
 Acciajo inossidabile

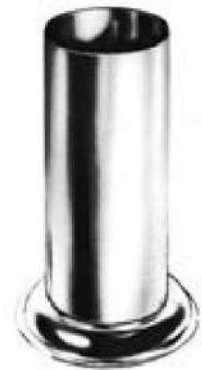
matt  
 satin finish  
 pulidas mate  
 opaco



| l    | Code       |
|------|------------|
| 0,25 | EV89140-02 |
| 0,5  | EV89140-05 |
| 1,0  | EV89140-10 |
| 2,0  | EV89140-20 |



**EV89141-10**  
 100 x 20 mm



|                   | mmxmm         |
|-------------------|---------------|
| EV89142-01        | 30x 90        |
| EV89142-02        | 50x100        |
| <u>EV89142-03</u> | <u>50x130</u> |
| EV89142-04        | 50x175        |
| EV89142-05        | 75x100        |
| <u>EV89142-06</u> | <u>75x130</u> |
| EV89142-07        | 75x175        |



EV89147-21 - EV89147-42

| l x b x h  |                      |
|------------|----------------------|
| EV89147-21 | 210x160x10 mm        |
| EV89147-24 | 240x180x10 mm        |
| EV89147-30 | <u>310x150x10 mm</u> |
| EV89147-31 | 310x210x10 mm        |
| EV89147-35 | 350x240x10 mm        |
| EV89147-40 | <u>400x270x20 mm</u> |
| EV89147-42 | 420x280x10 mm        |



EV89145-23 - EV89145-40

| l x b x h  |                      |
|------------|----------------------|
| EV89145-23 | 230x155x30 mm        |
| EV89145-30 | 300x175x30 mm        |
| EV89145-31 | <u>300x175x40 mm</u> |
| EV89145-35 | 350x240x36 mm        |

Wattedosen, Medizinlöffel, -becher  
 Cotton wool containers, Medicine Spoon and Cups  
 Distribuidores de algodón, Cuchara graduada, Vasos graduados  
 Vaso portacotone, Cucchiaino per medicinali, bicchieri per medicinali



mit Deckel  
 with Lid  
 Tapa  
 Coperchio



EV89146-20 20 cc  
 110 x 20 mm

|            | ø      | h       | l      |
|------------|--------|---------|--------|
| EV89143-00 | 6 cm   | 6 cm    | 0,15 l |
| EV89143-01 | 8,5 cm | 8,5 cm  | 0,4 l  |
| EV89143-02 | 8,5 cm | 12,5 cm | 0,6 l  |
| EV89143-03 | 8,5 cm | 5 cm    | 0,25 l |
| EV89143-04 | 10 cm  | 10 cm   | 0,75 l |
| EV89143-05 | 10 cm  | 5 cm    | 0,35 l |
| EV89143-06 | 12 cm  | 12 cm   | 1,25 l |
| EV89143-07 | 15 cm  | 15 cm   | 2,5 l  |
| EV89143-08 | 15 cm  | 10 cm   | 1,75 l |
| EV89143-09 | 20 cm  | 20 cm   | 6 l    |
| EV89143-10 | 20 cm  | 10 cm   | 3 l    |



EV89147-10 100 cc  
 EV89147-25 250 cc



EV89148-25 25 cc  
 EV89148-50 50 cc

Stechbecken, Plazentabecken, Sputumbecher  
Bed Pan, Placenta Pan, Sputum Cup  
Silleta, Cubeta para placenta, Escupidera  
Padella, bacinella per placenta, Sputacchiera



EV89148-31  
ø 310 mm



EV89148-32



EV89148-35  
350 x 290 x 90 mm



EV89150-30  
90 x 80 mm



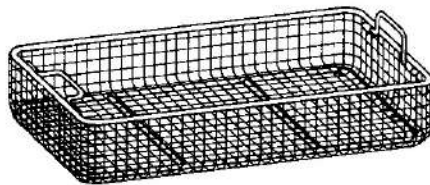


Verbandstofftrommel, Sterilisiersiebkorb  
 Sterilizing Drums, Sterilization Trays  
 Tambores p. esterilización, Cestas de esterilización  
 Tamburi p. sterilizzazione, Cestelli per erilizzazione

SCHIMMELBUSCH

|            | Ø    |       |
|------------|------|-------|
|            |      | mmxmm |
| EV89152-08 | 125x | 80    |
| EV89152-10 | 125x | 100   |
| EV89152-12 | 125x | 125   |
| EV89155-08 | 150x | 80    |
| EV89155-10 | 150x | 100   |
| EV89155-13 | 150x | 130   |
| EV89155-15 | 150x | 150   |
| EV89155-19 | 150x | 190   |
| EV89159-14 | 190x | 145   |
| EV89159-16 | 190x | 165   |
| EV89159-19 | 190x | 190   |
| EV89159-24 | 190x | 240   |
| EV89164-14 | 240x | 145   |
| EV89164-16 | 240x | 165   |
| EV89164-19 | 240x | 190   |
| EV89164-24 | 240x | 240   |
| EV89164-29 | 240x | 290   |
| EV89164-34 | 240x | 340   |
| EV89164-39 | 240x | 390   |
| EV89169-14 | 290x | 145   |
| EV89169-16 | 290x | 165   |
| EV89169-19 | 290x | 190   |
| EV89169-24 | 290x | 240   |
| EV89169-29 | 290x | 290   |
| EV89169-34 | 290x | 340   |
| EV89169-39 | 290x | 390   |
| EV89174-14 | 340x | 145   |
| EV89174-16 | 340x | 165   |
| EV89174-19 | 340x | 190   |
| EV89174-24 | 340x | 240   |
| EV89174-29 | 340x | 290   |
| EV89174-34 | 340x | 340   |
| EV89174-39 | 340x | 390   |
| EV89179-14 | 390x | 145   |
| EV89179-16 | 390x | 165   |
| EV89179-19 | 390x | 190   |
| EV89179-24 | 390x | 240   |
| EV89179-29 | 390x | 290   |
| EV89179-34 | 390x | 340   |
| EV89179-39 | 390x | 390   |
| EV89179-49 | 390x | 490   |
| EV89179-59 | 390x | 590   |

18/10  
 Stainless Steel  
 Acero inoxidable  
 Acciajo inossidabile  
 Acciaio inossidabile

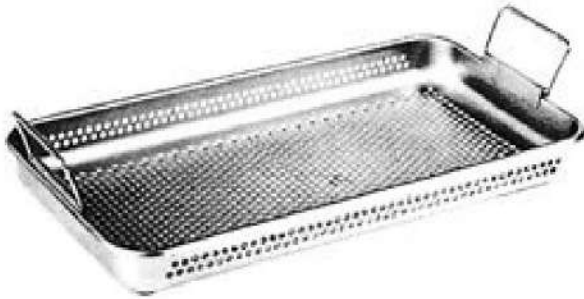


|         |          |        |
|---------|----------|--------|
| R390.03 | 255x245x | 30 mm  |
| R390.05 | 255x245x | 50 mm  |
| R390.07 | 255x245x | 70 mm  |
| R390.10 | 255x245x | 100 mm |
| R190.03 | 485x255x | 30 mm  |
| R190.05 | 485x255x | 50 mm  |
| R190.07 | 485x255x | 70 mm  |
| R190.10 | 485x255x | 100 mm |
| R191.03 | 540x255x | 30 mm  |
| R191.05 | 540x255x | 50 mm  |
| R191.07 | 540x255x | 70 mm  |
| R191.10 | 540x255x | 100 mm |

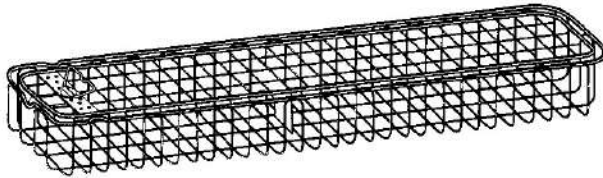
Siebschalen, Endoskopiekorb  
Trays  
Bandejas  
Cestelli

Aus perforiertem Blech  
From Perforated Sheet Metal  
De chapa de acero perforada  
In acciaio perforato

18/10  
Stainless Steel  
Acero inoxidable  
Acciajo inossidabile



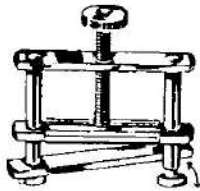
|            | mm x mm x mm    |
|------------|-----------------|
| EV89250-10 | 240 x 240 x 50  |
| EV89250-20 | 240 x 240 x 80  |
| EV89250-30 | 240 x 240 x 100 |
| EV89250-40 | 480 x 260 x 50  |
| EV89250-50 | 520 x 260 x 80  |
| EV89250-60 | 520 x 260 x 100 |



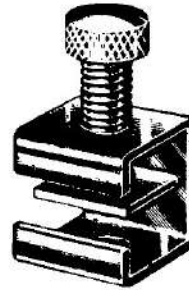
für 1 Endoskop, for 1 endoscope,  
para 1 endoscopio, per 1 endoscopio  
EV89256-29 290x80x52 mm  
EV89256-46 460x80x52 mm  
EV89256-67 670x80x52 mm

für 2 Endoskope, for 2 endoscopes,  
para 2 endoscopios, per 2 endoscopi rigidi  
EV89257-46 460x80x52 mm

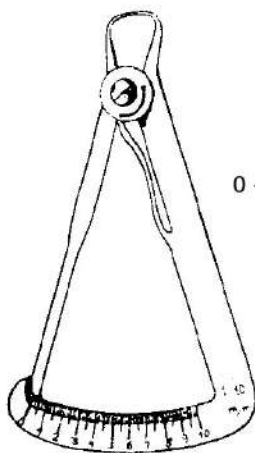
Schlauchklemmen, Messgerät, Sterilisierklammern  
 Tubing Clamp, Decimal spring caliper, Safety pins  
 Pinzas para tubos, calibrador decimal, Cadres de estérilizacion  
 Morsetti serratubi, compasso, pinze per sterilizzazione



HOFFMANN  
 EV89260-13 13 mm  
 EV89260-17 17 mm  
 EV89260-20 20 mm  
 EV89260-25 25 mm  
 EV89260-30 30 mm  
 EV89260-40 40 mm



SIMPLEX  
 EV89265-12

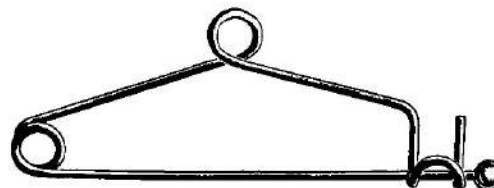


IWANSON  
 EV89270-15

0 - 10 mm



BUNT  
 EV29150-12  
 12 cm, 4<sup>3</sup>/<sub>4</sub>"



MAYO  
 EV29152-14  
 14 cm, 5<sup>1</sup>/<sub>2</sub>"

Reinigungspistole  
Water Jet Pistol  
Pistola-lavatora  
Pistola lavatrice



EV89500-00  
komplett mit 9 Aufsätzen  
complete with 9 tips  
con 9 toberas completa  
con 9 raccordi



EV89500-01  
Reinigungsaufsatz für Flaschen  
Cleansing Tip for bottles  
Tobera para botellas  
Raccordo di lavaggio per bottiglie



EV89500-02  
Reinigungsaufsatz für Recordspritzen-Konen  
Cleansing Tip for Cones of Record Syringes  
Tobera para conos de jeringas Record Raccordo per coni di siringhe Record



EV89500-03  
Reinigungsaufsatz für Katheter  
Cleansing Tip for Catheters  
Tobera para catéteres Raccordo di lavaggio per cateteri



EV89500-04  
Reinigungsaufsatz für Drainageschläuche  
Cleansing Tip for Drainage Tubings  
Tobera para tubos de drenaje  
Raccordo di lavaggio per tubi di drenaggio



EV89500-05  
Reinigungsaufsatz für Hohlgefäße (Brause)  
Cleansing Tip for Receptacles (Shower)  
Tobera para recipientes (ducha) Raccordo di lavaggio per recipienti (doccia)

EV89500-12  
Pistole allein  
Pistol only  
Pistola sola  
Pistola sola

EV89500-06

Reinigungsaufsatz für Kanülen mit Recordkonus Cleansing Tip for hypodermic needles with Record Cone Tobera para agujas de inyección con cono Record Raccordo di lavaggio per aghi ipodermici con cono Record



EV89500-07

Reinigungsaufsatz für Kanülen mit Luerkonus Cleansing Tip for hypodermic needles with Luer Cone Tobera para agujas de inyección con cono Luer Raccordo di lavaggio per aghi ipodermici con cono Luer



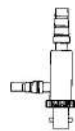
EV89500-08

Reinigungsaufsatz für Meß- und Vollpipetten  
Cleansing Tip for Meas. and Volumetric Pipettes  
Tobera para pipetas de medida y volumétricas Raccordo di lavaggio per pipette comuni e graduate



EV89500-09

Reinigungsaufsatz für feine Pipetten  
Cleansing Tip for fine pipettes  
Tobera para pipetas finas Raccordo di lavaggio per pipette fine



EV89500-10

Reinigungsaufsatz 31 cm (12 1/4") gerade  
Cleansing Tip 31 cm (12 1/4") straight  
Tobera 31 cm (12 1/4") recta  
Raccordo 31 cm (12 1/4") rette



EV89500-11

Reinigungsaufsatz 30 cm (11 3/4") aufgebogen  
Cleansing Tip 30 cm (11 3/4") curved  
Tobera 30 cm (11 3/4") curva  
Raccordo di lavaggio 30 cm (11 3/4") curvo

EV89501-03

Überwurfmutter zum Anschluß an Gewindehähne  
Couplings for connection to water tap Tuercas-hembras para conexión al grifo de agua Dadi premistoppa per connessione ai rubinetti filettati



EV91010-01  
 Fig. 1



EV91010-02  
 Fig. 2 45°



EV91010-03  
 Fig. 3 120°



EV91010-11  
 Fig. 11  
 Ø 3 mm



EV91010-12  
 Fig. 12  
 Ø 5 mm



EV91010-13  
 Fig. 13  
 Ø 8 mm



EV91010-14  
 Fig. 14



EV91010-15  
 Fig. 15 45°  
 7,0x1,5 mm



EV91010-16  
 Fig. 16 45°  
 7 mm



EV91010-17  
 Fig. 17  
 6,0x1,3 mm



EV91010-18  
 Fig. 18 30°  
 7,0x1,7 mm



EV91010-21  
 Fig. 21  
 7,0x1,7 mm



EV91010-31  
 Fig. 31 45°  
 Ø 0,6 mm



EV91010-33  
 Fig. 33 45°  
 Ø 1,7 mm



EV91010-34  
 Fig. 34 45°  
 Ø 3,0 mm



EV91010-35  
 Fig. 35



EV91010-36  
 Fig. 36 90°

Schaft  
 shaft  
 vástago  
 asta  
 Ø 2,4 mm

Mindestbestellmenge 10  
 Minimum order quantity 10  
 Cantidad minima 10  
 Minimo di quantitativo 10

Hochfrequenz-Chirurgie  
 High Frequency Surgery  
 Electrocirugía  
 Elettrochirurgia



EV91011-51  
 Fig. 51 45°  
 Ø 3 mm



EV91011-52  
 Fig. 52 45°  
 7,0x1,7 mm



EV91011-53  
 Fig. 53 45°



EV91011-54  
 Fig. 54



EV91011-55  
 Fig. 55



EV91011-56  
 Fig. 56 45°  
 Ø 5 mm



EV91011-61  
 Fig. 61 45°



EV91011-62  
 Fig. 62 90°

Schaft  
 shaft  
 vástago  
 ast  
 Ø 2,4 mm

Serie STANDARD



EV91020-01



EV91020-02

Schaft  
 shaft  
 vástago  
 asta  
 Ø 4 mm



EV91020-03



EV91020-04



Ø mm  
 5 EV91022-05



Ø mm  
 10 EV91024-10



Ø mm  
 2 EV91030-02

10 EV91022-10

15 EV91024-15

4 EV91030-04

20 EV91022-20

20 EV91024-20

6 EV91030-06

Schaft  
 shaft  
 vástago  
 asta  
 Ø 4 mm

Bipolare Koagulation  
 Bipolar Coagulation  
 Coagulación bipolar  
 Coagulazione bipolare



EV91102-11  
 11 cm, 4 <sup>3</sup>/<sub>8</sub>"



EV91104-11  
 11 cm, 4 <sup>3</sup>/<sub>8</sub>"



EV91109-11  
 11 cm, 4 <sup>3</sup>/<sub>8</sub>"  
 45°  
 0.5 mm



EV91113-11  
 11 cm, 4 <sup>3</sup>/<sub>8</sub>"  
 45°  
 0.5 mm



EV91115-11  
 11 cm, 4 <sup>3</sup>/<sub>8</sub>"  
 45°  
 0.5 mm



EV91122-16  
 16,5 cm, 6 <sup>1</sup>/<sub>2</sub>"  
 0.5 mm



EV91123-16  
 16,5 cm, 6 <sup>1</sup>/<sub>2</sub>"  
 0.5 mm



EV91124-16  
 16,5 cm, 6 <sup>1</sup>/<sub>2</sub>"  
 1 mm



EV91125-16  
 16,5 cm, 6 <sup>1</sup>/<sub>2</sub>"  
 0.5 mm



EV91127-16  
 16,5 cm, 6 <sup>1</sup>/<sub>2</sub>"  
 1 mm

Bipolare Koagulation  
 Bipolar Coagulation  
 Coagulación bipolar  
 Coagulazione bipolare



EV91142-16  
 16,5 cm, 6 1/2"  
 1 mm



EV91144-16  
 16,5 cm, 6 1/2"  
 0.5 mm



EV91146-16  
 16,5 cm, 6 1/2"  
 1 mm



EV91152-19  
 19,5 cm, 7 3/4"  
 0.3 mm



EV91154-19  
 19,5 cm, 7 3/4"  
 1 mm



EV91157-19  
 19,5 cm, 7 3/4"  
 1 mm



EV91159-19  
 19,5 cm, 7 3/4"  
 2 mm



Bipolare Koagulation  
 Bipolar Coagulation  
 Coagulación bipolar  
 Coagulazione bipolare



EV91162-19  
 19,5 cm, 7 3/4"  
 0.3 mm



EV91164-19  
 19,5 cm, 7 3/4"  
 1 mm



EV91166-19  
 19,5 cm, 7 3/4"  
 2 mm



EV91167-19  
 19,5 cm, 7 3/4"  
 1 mm



EV91169-19  
 19,5 cm, 7 3/4"  
 1 mm



EV91172-03 - EV91172-12  
 22,5 cm, 8.9"



EV91172-03  
 0,3 mm



EV91172-07  
 0,7 mm



EV91172-12  
 1,2 mm

Verbindungskabel, bipolar  
 Connection Cords, bipolar  
 Cables de conexión, bipolar  
 Cavi da connessione, bipolare



|     |      |                         |            |                                 |
|-----|------|-------------------------|------------|---------------------------------|
|     |      | ERBE<br>SELECT<br>STORZ | USA Mod.   | MARTIN<br>BERCHTOLD<br>AESCULAP |
| 3 m | 118" | EV91190-30              | EV91192-30 | EV91193-30                      |
| 5 m | 197" | EV91190-50              | EV91192-50 | EV91193-50                      |

für Elektro-Chirurgie-Einheiten  
 for Electrosurgery Equipment  
 para Electrobisturías  
 per Elettrobisturi

Monopolare Pinzetten  
Monopolar Forceps  
Pinzas monopolares  
Pinze monopolare



EV91800-18 18 cm, 7"  
EV91800-21 21 cm, 8 1/4"  
EV91800-25 25 cm, 10"

ohne Buchse with-  
out socket sin  
casquillo senza  
presa



EV91801-18 18 cm, 7"  
EV91801-21 21 cm, 8 1/4"  
EV91801-25 25 cm, 10"

mit Buchse with  
socket con  
casquillo con  
presa